

CRL GLASS WALL AND POOL FENCING SYSTEMS

MANUFACTURED BY C.R. LAURENCE COMPANY

AUGW15
CATALOGUE



GLASS FENCING SYSTEMS, POOL ENCLOSURES, AND MUCH MORE...

- NEW PRODUCTS ENGINEERED AND DESIGNED FOR RESIDENTIAL AND COMMERCIAL NEEDS
- COMPONENT AND ACCESSORY ITEMS COMPLEMENT EACH PRODUCT LINE



C.R. LAURENCE OF AUSTRALIA

Worldwide Manufacturer and Supplier

Glazing, Architectural, Railing, Construction, Industrial, and Automotive Supplies

crlaurence.com.au

usalum.com

crl-arch.com



CRL's AWS Aluminium Windscreen System



CRL's AWS Aluminium Windscreen System

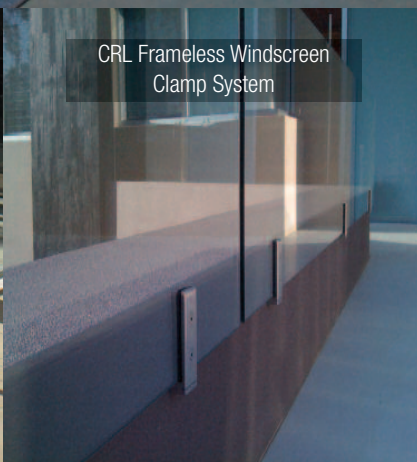

CRL Frameless Windscreen Clamp System



CRL AWS Aluminium Windscreen System

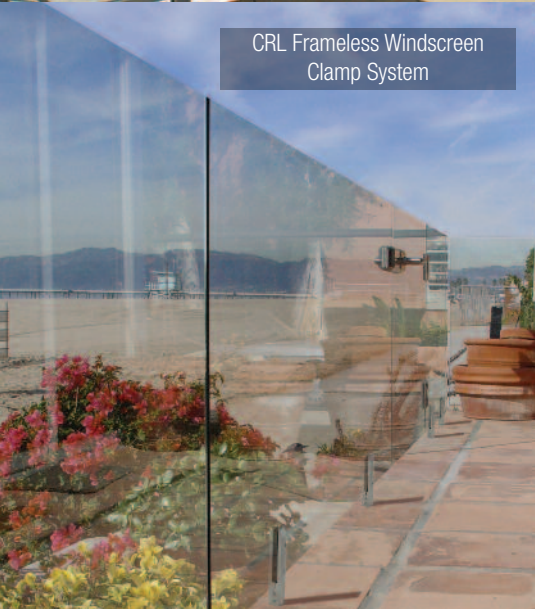

CRL Frameless Windscreen Clamp System



CRL Frameless Windscreen Base Shoe System

CRL FRAMELESS WINDSCREEN CLAMP SYSTEM / SPIGOTS

CRL's Frameless Glass Windscreen Clamp System is typically used for windscreens or pool deck surrounds. They were developed in Australia to create a windscreen that minimizes distractions from vertical or horizontal frame members. CRL has multiple designs to choose from that are manufactured for surface, core, and fascia mounted applications. Two architectural stainless steel finishes are available from stock. They are designed to support 12 mm (1/2") glass.



Pages 6-7



CRL FRAMELESS WINDSCREEN BASE SHOE SYSTEM

CRL's Frameless Windscreen Base Shoe System is typically used for windbreaks, pool decks, and glass fencing surrounds. This system minimizes visual distractions for the virtually unobstructed views it provides. CRL has multiple profiles to select from for monolithic toughened and laminated toughened glass, and cladding in six architectural finishes.

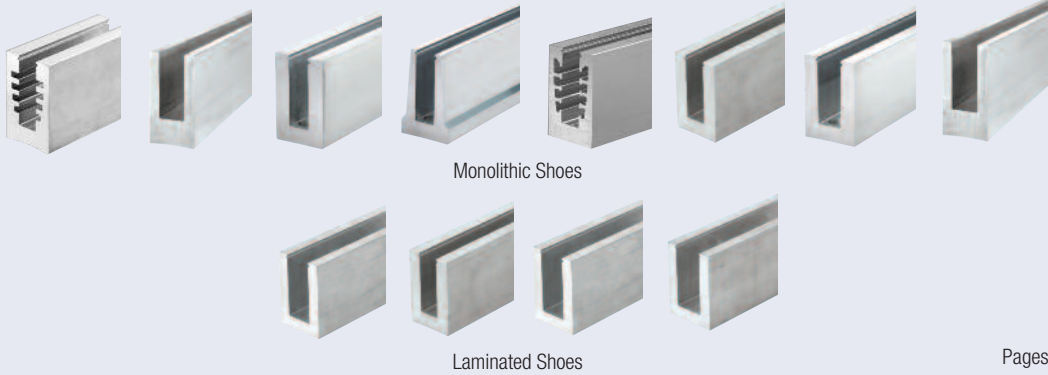

Pages 8-9



CRL AWS ALUMINIUM WINDSCREEN SYSTEM

CRL's Aluminium Windscreen System was developed to provide a sturdy low maintenance transparent glass fence. This system is offered in seven standard powder coated finishes, and can be mounted to a wide range of substrates.

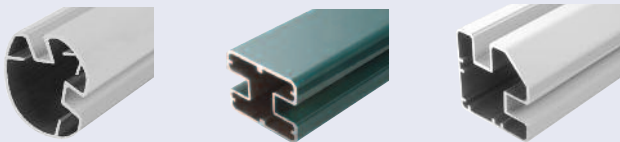

Pages 10-11



CRL GATE SYSTEMS AND HARDWARE

Gates are an integral part of most glass fencing projects. CRL offers a range of gate components for residential or commercial applications. Offered in multiple architectural finishes, these components will complement the total installation.

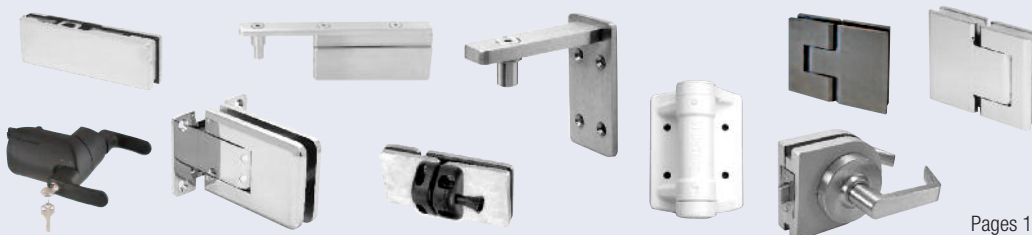

Pages 12-13

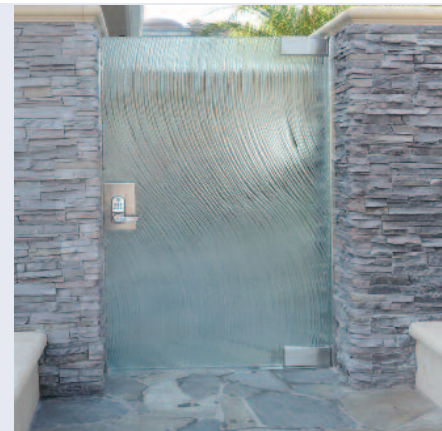



CUSTOM APPLICATIONS

CRL has the ability to design, engineer, and fabricate almost any architectural design. Most recently, CRL had the opportunity to develop and supply a number of products for the CityCenter Las Vegas project that included custom fabricated stainless steel LED lighted railing and hand rail systems, as well as custom glass wall systems and architectural metals.

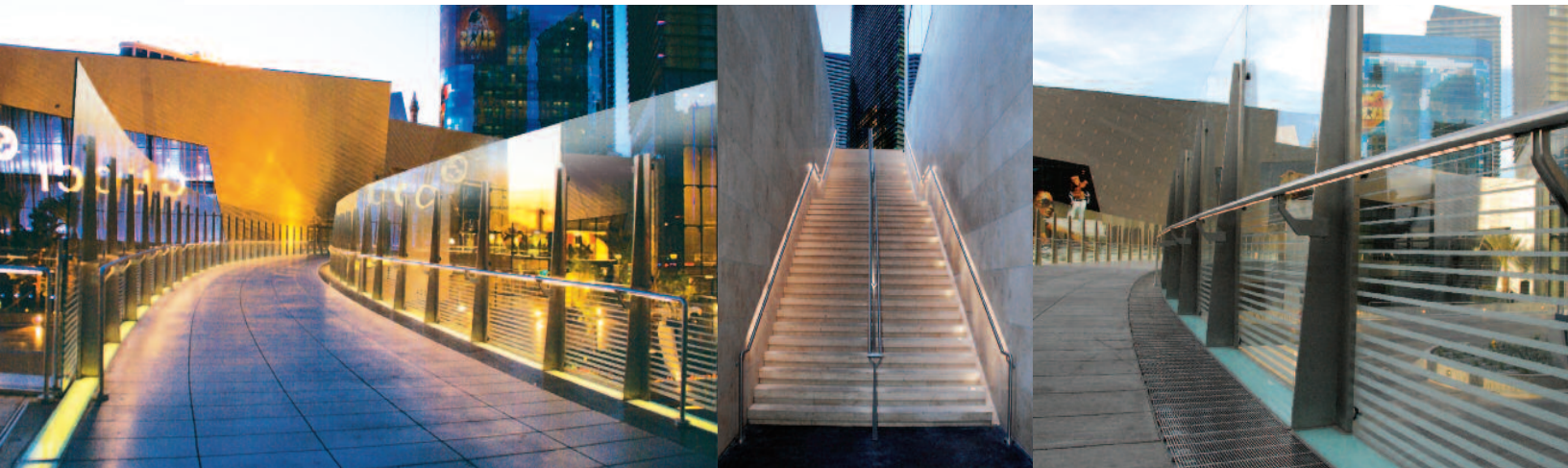



CRL GLASS WINDSCREEN AND POOL SURROUNDS

CRL's Frameless Glass Windscreen Base Shoe System and Frameless Windscreen Brackets are designed to provide an attractive, maintenance-free glass wall that will enhance any residential or commercial application. This system offers virtually unobstructed views for glass windscreen or fencing requirements. (Not designed for guard rail applications). CRL's Frameless Windscreen Systems are innovative glass wall systems that provide an almost invisible "frameless" look without vertical posts used between the panels of glass. They are solely supported from the bottom by aluminium base shoes or high strength stainless steel clamps.

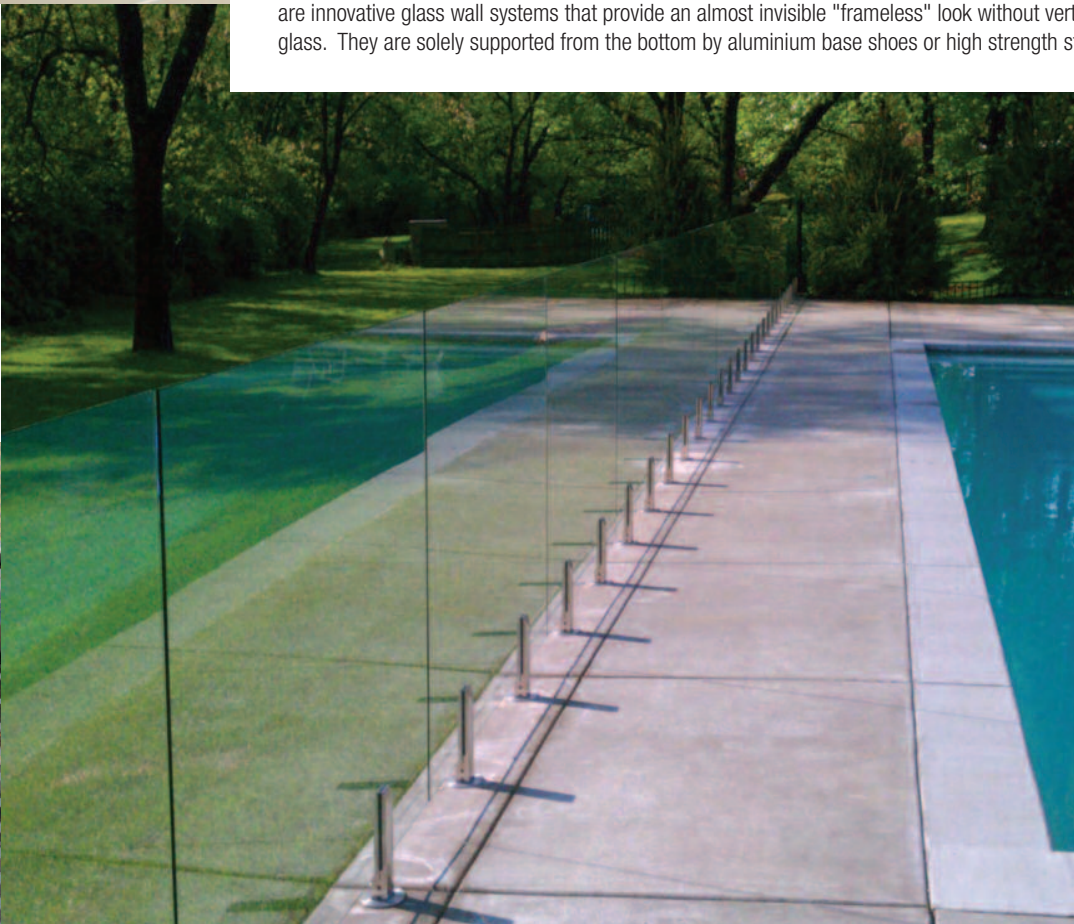

CRL FRAMELESS WINDSCREEN CLAMP SYSTEM

- Also Known as Spigots
- Gives a Frameless 'All-Glass' Look
- Great for Pool Fencing, Balcony and Deck Applications
- Available in Two Standard Architectural Finishes
- 316 Alloy and Duplex 2205 Marine Grade Finishes
- Designed for 12 mm (1/2") Toughened Glazing

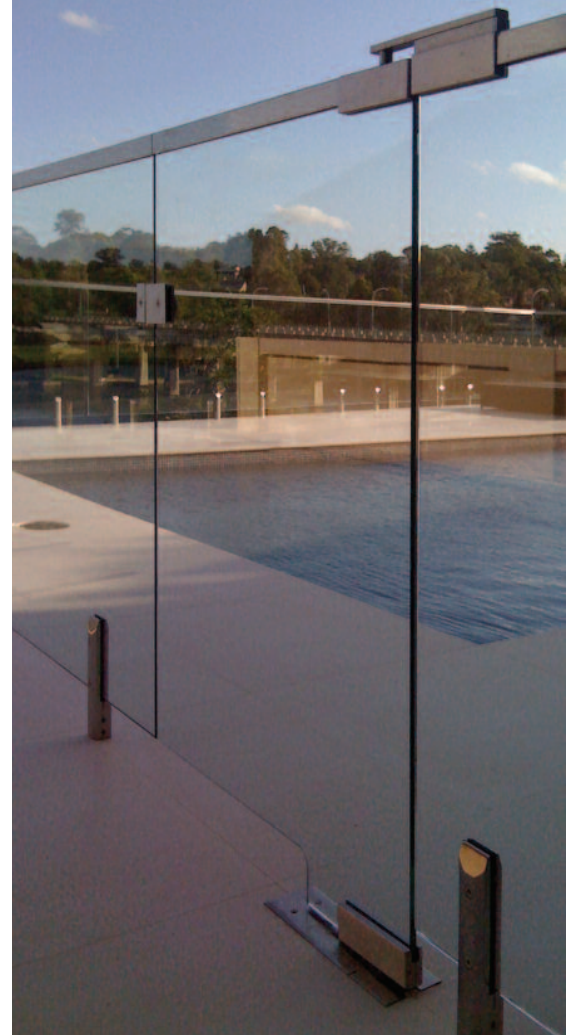

Our Frameless Windscreen Clamps, which are also known as Spigots, provide a break from the wind using an almost invisible "frameless" look. No vertical posts are used between the panels of glass; they are solely supported from the bottom by these high strength stainless steel clamps. They are intended for use with 12 mm (1/2") thick toughened glass panels. Their quality 316 alloy stainless steel construction provides superior weather resistance, and there are two models made of Duplex 2205 Marine Grade stainless for installations within one kilometer of saltwater environments.

Core, side, and new surface mount models give you a choice of installation options. All models are available in a brushed stainless finish, and some are also available in a polished finish. Optional U-Channel Cap can be added to finish the installation. Please contact the CRL Technical Sales Staff about this safe and attractive solution to your windscreen needs for balconies, decks, and pool surrounds.

CRL WINDSCREEN CLAMPS / SPIGOTS

- Quality Stainless Steel in Six Distinct Designs
- Suitable for 12 mm (1/2") Toughened Glass
- Friction Fit Models Require No Glass Fabrication
- 316 Stainless Steel in Brushed or Mirror Polished Finishes
- Core Mount, Surface Mount, and Side Mount
- Cover Plates Included



CORE MOUNT FRICTION FIT SQUARE CLAMP

- 316L Low Carbon Grade Stainless Steel
- Garnish Ring Included



CAT. NO.	HEIGHT	FINISH
FWCS10BS	175 mm (6-7/8")	Brushed Stainless Steel
FWCS10PS	175 mm (6-7/8")	Polished Stainless Steel



CORE MOUNT FRICTION FIT ROUND CLAMP

- 316L Low Carbon Grade Stainless Steel
- Garnish Ring Included



CAT. NO.	HEIGHT	FINISH
FWCR10BS	175 mm (6-7/8")	Brushed Stainless Steel
FWCR10PS	175 mm (6-7/8")	Polished Stainless Steel



SURFACE MOUNT FRICTION FIT SQUARE CLAMP

- 316L Low Carbon Grade Stainless Steel
- Garnish Ring Included



CAT. NO.	HEIGHT	FINISH
FWCS20BS	149 mm (5-7/8")	Brushed Stainless Steel
FWCS20PS	149 mm (5-7/8")	Polished Stainless Steel



SURFACE MOUNT FRICTION FIT ROUND CLAMP

- 316L Low Carbon Grade Stainless Steel
- Garnish Ring Included



CAT. NO.	HEIGHT	FINISH
FWCR20BS	149 mm (5-7/8")	Brushed Stainless Steel
FWCR20PS	149 mm (5-7/8")	Polished Stainless Steel



TWO-PIECE SIDE MOUNT CLAMP

- Mounts on Face of Wall or Planter Box
- Requires Holes in Glass

CAT. NO.	HEIGHT	FINISH
AFWC2	143 mm (5-5/8")	Brushed Stainless Steel



THREE-PIECE CORE MOUNT CLAMP

- Duplex 2205 Grade Stainless has Higher Corrosive Resistance
- Requires Holes in Glass

CAT. NO.	HEIGHT	FINISH
DFWC3	220 mm (8-5/8")	Brushed Stainless Steel



CRL KWIXSET® EXPANDING CEMENT

- Expands as Clamps Set
- Fast Setting, Will Not Shrink or Crack When Used as Directed

CRL recommends the use of Kwixset® with core mount spigots. Fastest curing grout on the market eliminating the need to support glass for extended periods.

CAT. NO.	SIZE
KWX25	11.3 kg (25 lbs)
KWX50	22.7 kg (50 lbs)

CRL U-CHANNEL CAP OPTIONAL TOP EDGE PROTECTION



GRUC5 Series

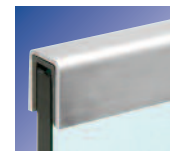

GRL10 Series



GRLC10 Series

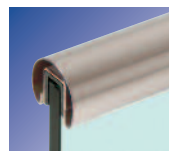

GR15 Series

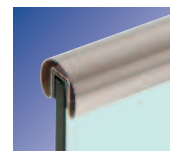

SL30 Series



GRS15 Series

CRL FRAMELESS WINDSCREEN BASE SHOE SYSTEM

- Great for Glass Windbreaks, Pool Enclosures, Perimeter Fencing, Sound Barriers, Balconies, and Any Applications That are View-Oriented
- Unique Designs That Allow Completely Unobstructed Views
- Designed and Engineered to Meet the Strictest Codes
- Custom Fabrication is Also Available to Meet Your Specifications

CRL BASE SHOE PROFILES

- Drilled and Counter Bored Base Shoes for Monolithic and Laminated Toughened Glazing
- Typically Used as the Base Channel for Glass Windscreen or Railing Systems
- Six Architectural Finishes Available

CRL ALUMINIUM BASE SHOES

- Choices Available for Various Glass Thicknesses

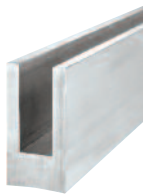

B5B Series
10 mm
Monolithic Glass



B5A Series
12 mm
Monolithic Glass
SurfaceMate®



B5S Series
12 mm
Monolithic Glass



B5T Series
12 mm
Monolithic Glass



B5G Series
12 mm
Monolithic Glass

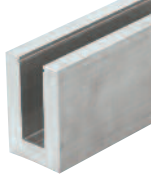

B6S/B6N Series
15 mm
Monolithic Glass



B7S Series
19 mm
Monolithic Glass



W7B Series
19 mm
Monolithic Glass

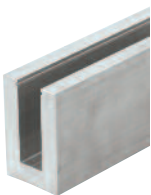

L56S Series
13.52 mm
Laminated Glass

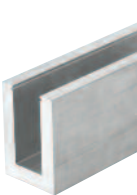

L68S Series
17.52 mm
Laminated Glass

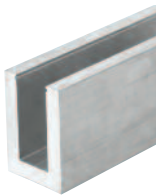

L21S Series
21.52 mm
Laminated Glass

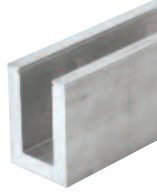

L25S Series
25.52 mm
Laminated Glass



CRL Aluminium Base Shoe is used as the base channel for glass railing systems and frameless glass windscreen systems. There are twelve distinct series to accommodate monolithic toughened and laminated toughened glass in various thicknesses from 10 to 25.52 millimeters.

In typical glass pool surrounds or frameless windscreen systems monolithic toughened is the glass of choice. But in situations where the glass panels are elevated above pedestrian areas, such as in shopping plazas or on balconies, the use of laminated toughened glass is recommended to prevent broken pieces from falling to lower levels.

CRL Aluminium Base Shoe is available for both choices. With our variety of Base Shoe Series there is really no reason not to select this tried and true method of anchoring glass panels. And CRL supports the method with both dry glazed and wet glazed installation methods, along with all of the tools and supplies required to make a safe and successful installation.

Stock Base Shoe is available pre-drilled and counter bored, or in un-drilled lengths that can be custom fabricated to your exact job requirements. Accessory cladding is available in six beautiful architectural finishes, or you can even specify custom powder-coated paint in hundreds of quick-turn colours.

For complete details on delivery and pricing of Aluminium Base Shoe, contact the CRL Railing Technical Sales Staff.

AVAILABLE BASE SHOE ACCESSORIES

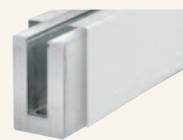

Base Shoe Cladding

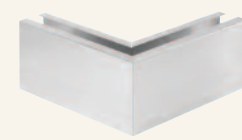

Mitered Corner Cladding



30 mm Rail Cap



Roll In Vinyl



Base Shoe End Caps

CRL DRY GLAZED TAPER-LOC® GLASS BALUSTRADE SYSTEM

- Now in Three Taper Designs to Meet All Residential and Commercial Applications Using Monolithic Toughened Glass and Laminated Toughened Glass
- Dry Glazing Means Installation Time is Reduced By 50 Percent Because There's No Mixing or Clean-Up of Messy Cement
- TAPER-LOC® Meets and Exceeds Code Standards
- Engineering and Testing Reports Available at crlaurence.com.au

The innovative GRS Glass Balustrade Dry Glazed TAPER-LOC® System has advantages other Balustrade systems cannot duplicate. Designed for residential and commercial applications, this system works with laminated and monolithic toughened glass balustrade and windscreen applications.

TAPER-LOC® Tapers are simply installed with CRL's exclusive TLK9 Installation Removal Tool. This tool mechanically slides the Tapers horizontally and compresses them together to secure the glass in the aluminium base shoe without the use of messy wet cement. When compressed, they expand in thickness and lock in place. The CRL TAPER-LOC® System reduces installation time by up to 50 percent, supports all mounting methods, and is designed to meet and exceed code standards.

- TAPER-LOC® Taper Sets for Monolithic Toughened and Laminated Toughened Glass



CAT. NO. TL5X10
for 12 to 19 mm Monolithic
Toughened Glass



CAT. NO. LTL96X
for 13.52 mm
Laminated Glass



CAT. NO. TL3X10
for 10 mm Monolithic
Toughened Glass

CAT. NO. LTL10X
for 21.52 mm or 25.52 mm
Laminated Glass

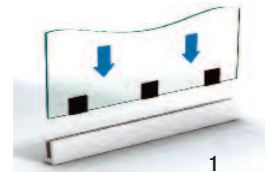
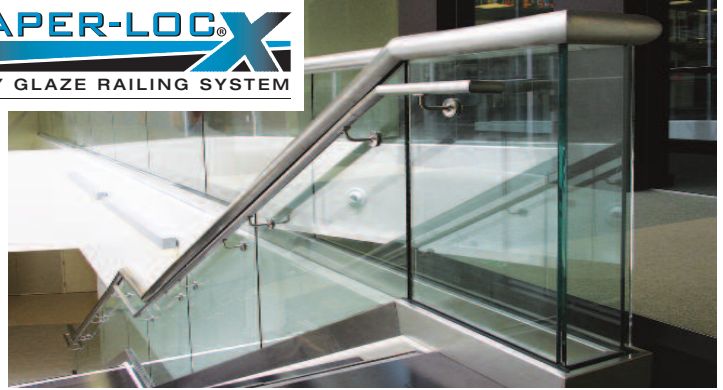

Adhere TAPER-LOC® L-Setting Blocks to the bottom edge of glass.

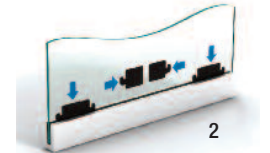
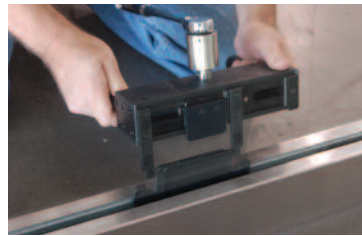

Install TAPER-LOC® Tapers with CRL's TLK9 Installation/Removal Tool to lock the glass securely in place.

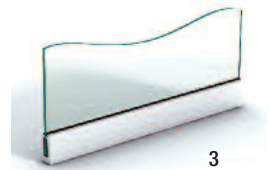

Roll in the glazing and you're done.

Installation Labour Time Reduced By 50%

- STEP 1** - Place the TAPER-LOC® Tapers into base shoe finger tight
STEP 2 - Place the TAPER-LOC® Installation/Removal Tool into position
STEP 3 - Tighten the TAPER-LOC® components using our Integrated Torque Wrench

TAPER-LOC® KIT

- Special Tools Reduce Installation Labour Time by 50 Percent
- Easily Allows You to Remove, Adjust, or Replace Glass Panels in Seconds
- Works With 10, 12, 13.52, 15, 17.52, 19, 21.52, and 25.25 mm Toughened Glass Panels



CAT. NO. PAL1K

CRL PAL Plumb/Angle/Level Locator Kit



CAT. NO. TLK9

CRL TAPER-LOC® Installation/Removal Tool Kit

CRL AWS ALUMINIUM WINDSCREEN SYSTEM

- Accepts 6 to 12 mm (1/4" to 1/2") Thick Glass for the Creation of Attractive and Functional Glass Barriers
- Seven Standard Colours Available in Stock
- Custom Colours Also Available

The AWS Aluminium Windscreen System was developed to provide an attractive, maintenance-free glass wall that will enhance any residential or commercial application. All AWS Systems can be used in conjunction with a concrete slab, block wall or individual footings. If our stock components do not fit your application, allow us to design a system that can. CRL has the ability to design, engineer, and fabricate a custom system that will satisfy not only your need for safety and security, but also your artistic tastes.



Visual Appeal

The property owner will love the clean look of this wall and the virtually unobstructed view it provides.

Noise Reduction

The AWS System is superbly suited as a sound wall along busy streets and highways. Our system provides a much higher sound transmission rating than conventional fencing.

Maintenance

The AWS System is low maintenance. All components are specially coated to prevent corrosion and ensure that the property owner will be satisfied for many years.

Flexibility

The AWS System adapts to a wide variety of terrain and wall designs. It can easily handle slopes, steps, and curves. In addition, the system is ideal for pool areas, decks, and balcony applications. This system can be installed during almost any phase of construction, allowing the builder or contractor important scheduling flexibility.

Integrity

The AWS System has been designed to provide a safe, transparent fence during high wind conditions. All glass installed must be fully toughened to meet all safety requirements and building codes.

Price

Because of this efficient design, our system is priced very competitively to other less attractive alternatives, such as wrought iron or wood fencing.

CRL AWS ALUMINIUM WINDSCREEN SYSTEM

50.8 x 66.7 mm (2" x 2-5/8") Rectangular Aluminium Windscreen Post Profiles

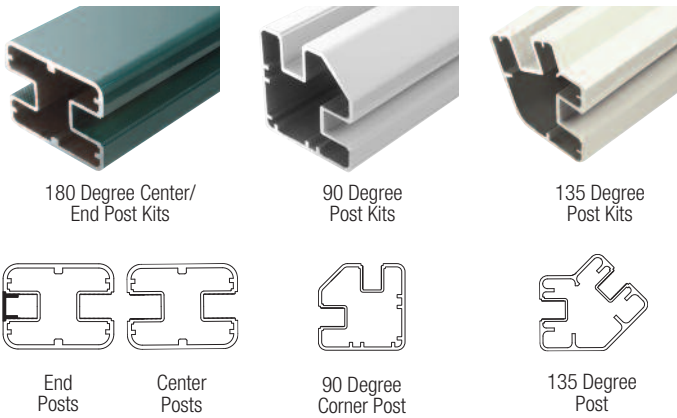

76.2 mm (3") Round Aluminium Windscreen Post Profiles

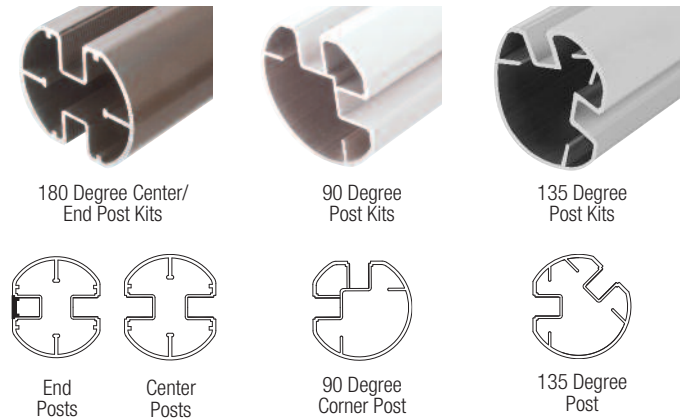

Unlike other glass wind wall systems, the AWS Aluminium Windscreen System keeps all aluminium out of contact with concrete. The lime in concrete is very corrosive to aluminium, and over time will degrade the physical properties of the components. The AWS System utilizes a painted steel embedment that supports the vertical post and eliminates the possibility of damaging corrosion. An added benefit of the steel embed is that the contractor can install the steel components early in the construction process, then install the painted aluminium post later when the chances of damage by the other tradesmen are greatly reduced. These are strong attributes of the AWS System, and have a real value to the builder and property owner.

The AWS System was designed to be a wind wall that is very aesthetically pleasing. Because of the great design and the interaction with the steel insert, AWS has enhanced structural properties, allowing for increased height and span capabilities.

TYPICAL MOUNTING OPTIONS

Core Mounted Installation for a Concrete Slab

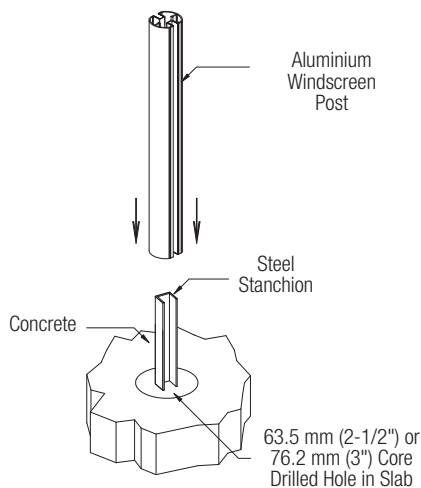

Core Mounted Installation for CMU Block Walls

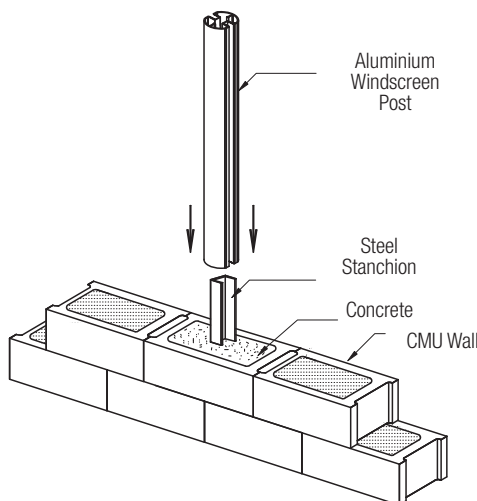

Surface Mounted Installation for a Concrete Slab

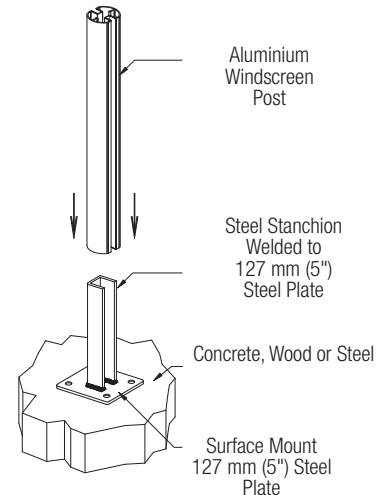

CRL GATE SYSTEMS AND HARDWARE

CRL GATE SYSTEMS

- Aluminium Gate Systems Custom Fabricated to Your Exact Needs
- Polaris Frameless Glass Gate Hinges
- Designs for Pool Surrounds, Patios, and Outdoor Dining Areas

We have the experience and the resources to create gate systems to your exact requirements that are both attractive in appearance and precise in function. These sturdy systems lend security to pool surrounds, patios, and outdoor dining areas. Our Technical Sales staff will help you design the perfect gate for just about any application.

CRL AWS GLASS GATE SYSTEMS

- Many Styles of Glass Gates in Seven Standard Colours, Plus Custom Colours for Passageways, Driveways, and Doors

Gates and Gate Systems are an integral part of most commercial, multi-family, and residential projects. Your choice of gate designs range from the basic swing gate to the most customized automatic or manual gate you can create. CRL Gates can accommodate standard, electronic or remotely operated locksets, as well as a variety of opening mechanisms.

STANDARD COLOURS (ALSO AVAILABLE UNFINISHED)



Colours shown are representative only, and may vary slightly from actual gloss, colour, and texture. If colour match is critical, please contact Technical Sales for additional information.

Additional Colour Options - CRL has over 250 quick turn custom colour options with the ability to colour match as well.



CRL POLARIS FRAMELESS GLASS GATE HINGES

- Complies With AS2820 & AS1926
- For 10 mm and 12 mm Glass
- 316 Marine Grade Stainless Steel
- Patented Soft Close Function
- Brushed or Mirror Polished Finish
- Mouse Ear Cut Out Required
- Maximum Gate Width 900 mm and Weight 50 Kgs

CRL Polaris Hinge has been specifically designed for pool gate applications and is the only frameless glass hinge on the market endorsed by the Royal Lifesaving Society of Australia.



Glass-to-Glass



Glass-to-Wall



CRL GATE HARDWARE

- Pivot Patches and Gate Fittings
- Gate Locks and Latches
- Hinge Mechanisms

We provide a large selection of hardware for the fabrication and mounting of attractive and secure gate systems. All of this hardware is designed to provide smooth operation and look good while doing it. Here are just some of your options. For the complete selection of CRL Gate Hardware visit crlaurence.com.au, or contact our Technical Sales Staff.

PIVOTS AND PATCH FITTINGS

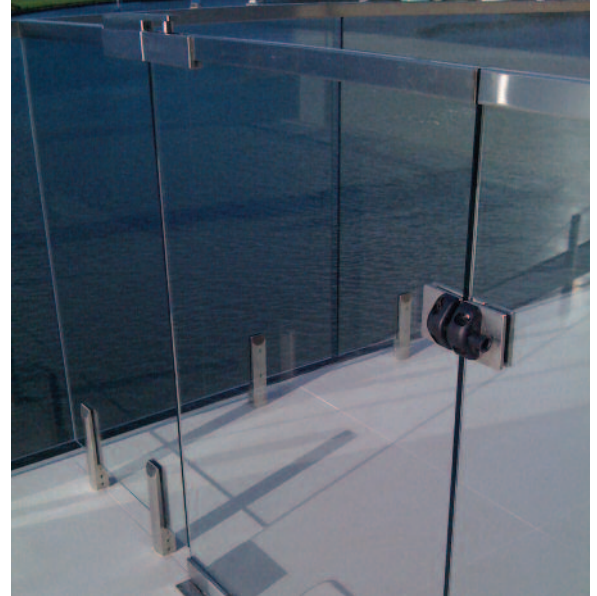

HINGES

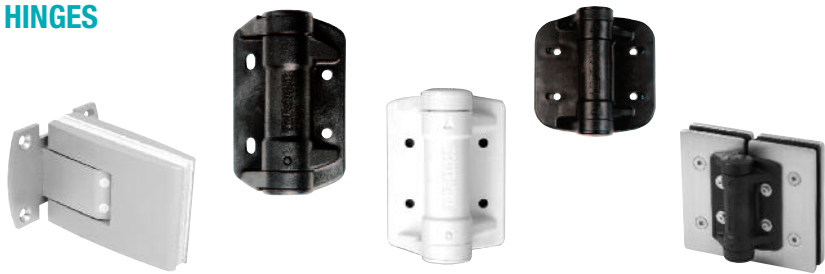

LOCKS AND LATCHES



CRL ARS PICKET FENCE AND GATE SYSTEMS FOR POOLS

- Extremely Sturdy and Maintenance Free
- Seven Standard Powder Painted Finishes
- Meets or Exceeds Code Requirements

Our Aluminium Railing System also makes for a safe and sturdy fence for swimming pools and spas in both residential and commercial applications. Each can be custom built to your exact requirements for safety while being an attractive addition to the swimming environment. Please contact us for details.



CRL ALUMINIUM AND GLASS RAILING SYSTEMS

- 6005-T5 Aluminium Alloy
- Surface, Core Hole or Fascia Mount Options
- 6 and 10 mm Glass, Aluminium Picket, Stainless Steel Mesh, Cables, or Custom Cast Infills
- Maximum Post Spacing 1.83 m Centre-to-Centre
- Suitable For Both Commercial and Residential Railings
- Complete Engineering Test Reports Available
- 6.1 m Stock Lengths

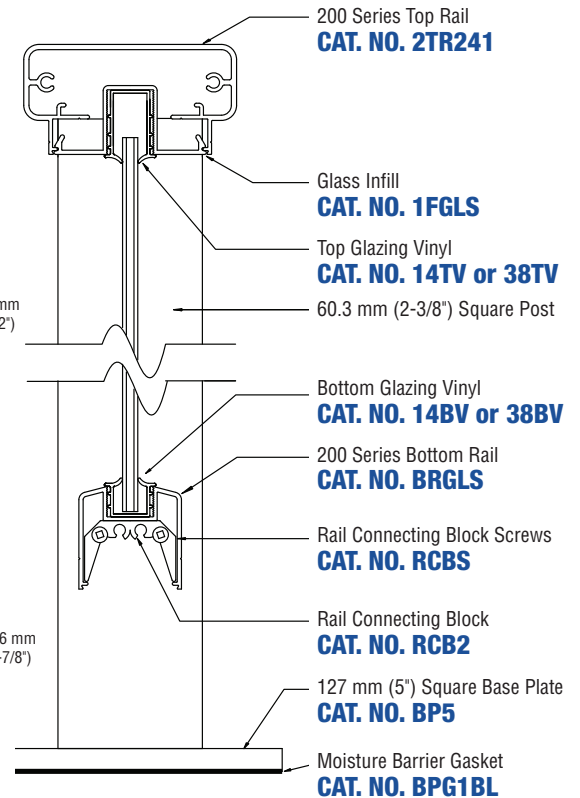
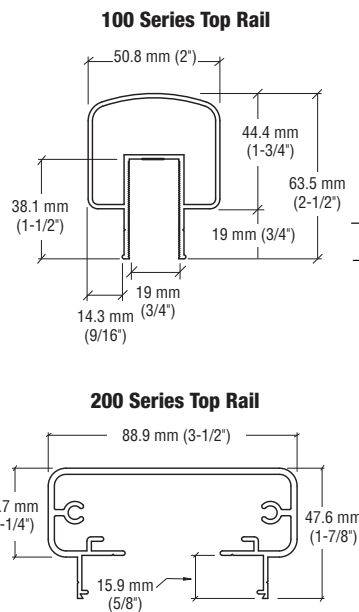
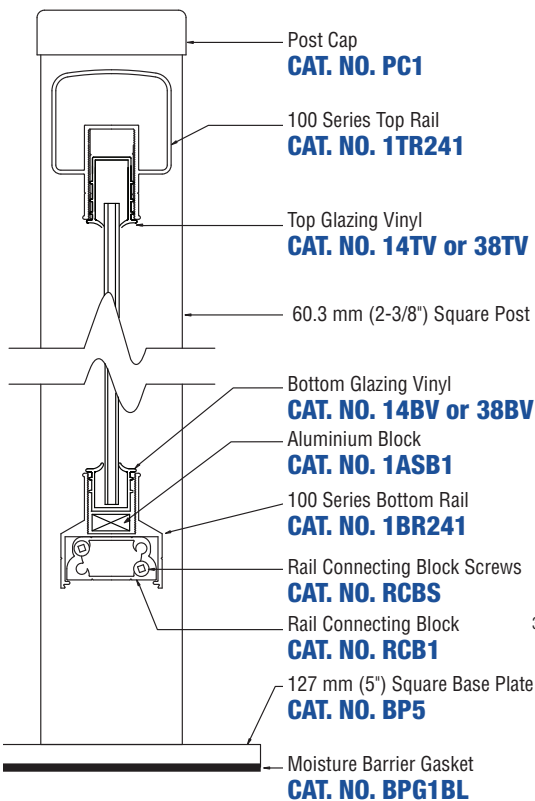



CRL ARS ALUMINIUM RAILING SYSTEMS

CRL's high quality, versatile 100, 200, 300, 350, and 400 Series Aluminium Railing Systems are manufactured from extruded aluminium framing members, all of which utilize toughened glass, aluminium pickets, cast infills, stainless steel mesh, or stainless steel cable that is engineered to meet applicable building codes. ARS is suitable for all commercial and residential applications.

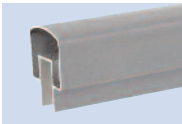

100 Series

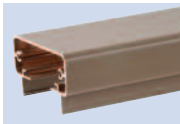

200 Series

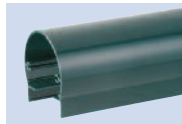

300 Series

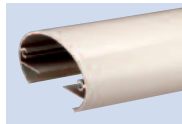

350 Series

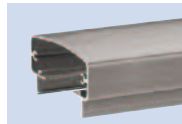

400 Series



Protective Security Screen
Infill Panels



CRL Mobile is Here!

Save Time On the Job, or On the Go

- Search for Products
- Personal Catalog
- View Product Details
- Find CRL Locations
- Contact Us
- Place an Order



Visit crlaurence.com.au
From Any Smart Device Today



- The Design and Layout Software Program Tailored to Professionals Doing Hand Rails, Guard Rails, Glass Balustrades, and Windscreens
- Innovative Web-Based Program That Generates Railing Layouts, Parts Lists, and Material Cut Sizes



- Six Easy Steps to Design a Railing System
- Generates Accurate Quotes Quickly
- Continual Upgrades to Program Since it is Web-Based
- Default Settings Can Be Customized to Suit Your Needs

Ask About Our **FREE**
30 Day Trial Offer

There's Nothing Else Like
Hand Rails Online!

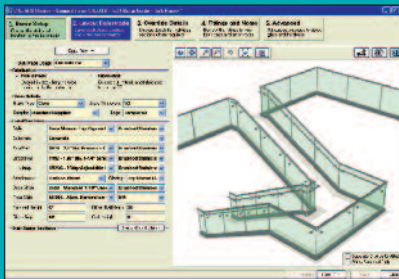

Sydney Area

9 Shale Place, Eastern Creek, NSW 2766

Local Phone: (02) 9851-3444 | Local Fax: (02) 9851-3445

Melbourne Area

42 Enterprise Drive, Rowville, VIC, Australia 3178

Local Phone: (03) 9764-8322 | Local Fax: (03) 9764-8378

Toll Free Phone: 1800 424 275 | Toll Free Fax: 1800 813 013