

glass

PRODUCT SHOWCASE

glasstec
SHOW SPECIAL

New and popular products
at discount prices

Tools and supplies for the glass shop

AUTUMN '14

GLASSTEC SPECIAL SAVINGS INSIDE!

 4	 14	 30	 Glass and Glazing Supplies  Shower Hardware  Door Hardware  Railing Hardware  Architectural Metals
 35	 6,7	 27	
 18	 10	 16	



ORDER TODAY FROM THE GLOBAL MARKET LEADER

VIEW ALL PRODUCT RANGES ONLINE
crlaurence.co.uk

Call FREE from the UK and Ireland on **00 800 0421 6144**

SHOW SPECIALS

Visit us at the show for extra discounts!

Can't make it?

Call CRL customer services for more details.



FIND US AT glasstec®

21st to 24th October,
Dusseldorf, Germany

Hall 10 Stands A48 / B48

glasstec®

SHOW GUIDE

SEE US IN HALL 10
STANDS A48 AND B48

CRL will be exhibiting a vast range of exciting new and popular products at glasstec® 2014.

New products like the CRL CABO Sliding Shower Door System, CRL Glass Awning Display (Bracket and Rod Canopy Systems) and the CRL 1202 Series Glass-to-Glass Mounted Gate will be seen for the first time.

More than 30 product displays and hundreds of individual products are being showcased over two stands (A48 /B48) in Hall 10, in **five specific zones**:

Shower Hardware

- CRL CABO Sliding Shower Door System Display **NEW**
- CRL Hydroslide and Serenity Sliding Shower Door System Displays
- CRL Essence Sliding Shower Door System Display
- CRL Riviera Shower Door Hinge Display **NEW**
- CRL Shower Support Bar Display



Glass and Glazing Supplies

- CRL Glass Handling Equipment **NEW**
- CRL Silicones, Sealants and Tools **NEW**
- CRL Mirror Products, Mastics and Adhesives **NEW**
- CRL Cleaning and Surface Protection **NEW**
- CRL Glazing Accessories **NEW**
- CRL Safety and Personal Protection Equipment **NEW**
- CRL Glass Cutting Equipment **NEW**
- CRL UV Bonding Equipment **NEW**



Railing Hardware

- CRL TAPER-LOC® Dry Glaze Railing System Display **NEW**
- CRL TAPER-LOC® Dry Glaze Railing System Demonstration Display
- CRL Railing System Display
- CRL Post Railing System Display
- CRL ARS and AWS Railing System Display **NEW**
- CRL Heavy Duty Standoff Display



Door Hardware

- CRL Laguna Sliding Door System Display
- CRL Door Rail Display **NEW**
- CRL Glass Partition Door Display **NEW**
- CRL USAL Interior Office Partitions Display **NEW**
- CRL 285 Series Slider Door System Display
- CRL 51 Series Ceiling Mount Single Slider with Soft Close Display
- CRL D Profile Panic Handle and F Style Pull Handle Display



Architectural Metals

- CRL 1202 Series Glass-to-Glass Mounted Gate **NEW**
- CRL Monterey Series Bi-Folding Glass Wall System Display **NEW**
- CRL Glass Awning Display, Bracket and Rod Canopy Systems **NEW**
- CRL Glass Spider Fittings Display
- CRL Glass Wall and Metal Sunshade Display



CRL TOYO® SUPERCUTTER® BRASS HANDLE STRAIGHT HEAD OIL CUTTER

glasstec® SPECIAL

SAVE
10%

- Equipped with new TOYO® patented Tap Wheel™ technology
- Precise grinding technology improves cutting
- New cemented carbide wheel and axle for improved durability
- Brass straight end handles
- 140° hone angle

FROM ONLY
£12.15*

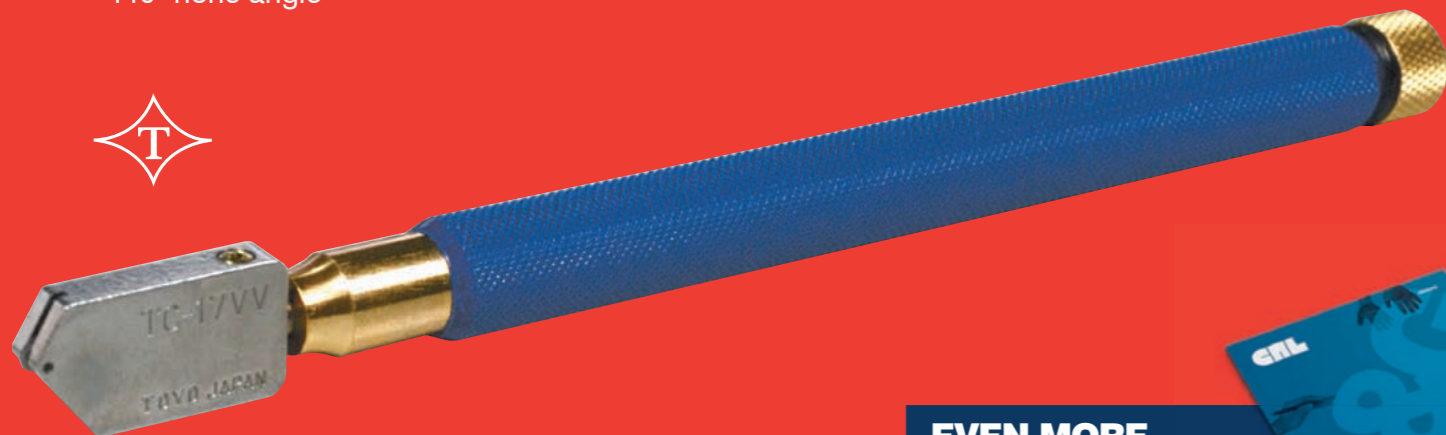

SALE PRICE EACH (INC. 10% DISCOUNT)

CAT. NO.	1	6	12
TC17VVB	£14.85	£14.15	£12.15

*Sale price based on order quantity of 12. Minimum order: 1 each. Supercutter® and Tap Heads are not interchangeable. Oil type glass cutters can be combined for quantity pricing.

**EVEN MORE
GREAT PRODUCTS**

VISIT crlaurence.co.uk
and view CAT. NO. GG2014A

CRL TOYO® DRY WHEEL SUPERCUTTER®

- Black handle and wide straight head
- Moulded handle for positive grip
- Long-lasting TOYO® carbide wheels

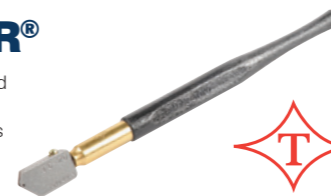

VERY POPULAR

FROM ONLY
£8.25*

SALE PRICE EACH (INC. 10% DISCOUNT)

CAT. NO.	HEAD TYPE	CUT TYPE	1	6	12
TC20	Wide	Straight	£10.05	£9.60	£8.25

CRL TOYO® COMFORT-GRIP SUPERCUTTER®

- Straight end handle
- Self-oiling
- Premium quality



FROM ONLY
£8.75*

GREAT VALUE

SALE PRICE EACH (INC. 10% DISCOUNT)

CAT. NO.	CUTTER MODEL	1	6	12
TC1S	Wide head	£10.70	£10.20	£8.75
TC1SR	Rainbow wide head	£11.15	£10.65	£9.15
TC1P	Pattern head	£10.70	£10.20	£8.75
TC1PR	Rainbow pattern head	£11.15	£10.65	£9.15

CRL TOYO® ORIGINAL SUPERCUTTER®

- Brass or plastic straight end handles
- 140 degree hone angle
- Carbide wheels
- Premium quality
- Now available with Tap Wheel™ (TC17BBV model)



FROM ONLY
£11.85*

SALE PRICE EACH (INC. 10% DISCOUNT)

CAT. NO.	HEAD TYPE	CUT TYPE	HANDLE	1	6	12
TC10B	Narrow	Pattern	Brass	£14.85	£14.15	£12.15
TC17B	Wide	Straight	Brass	£14.85	£14.15	£12.15
TC10P	Narrow	Pattern	Plastic	£14.45	£13.80	£11.85
TC17P	Wide	Straight	Plastic	£14.45	£13.80	£11.85
TC17BBV	Wide	Straight	Brass	£14.85	£14.15	£12.15

*Price based on order quantity of 12 each. Minimum order: 1 each. Supercutter® and Tap Heads are not interchangeable. Oil type glass cutters can be combined for quantity pricing.

Offer prices valid from 01-10-14 to 31-01-15

CRL TOYO® CUSTOM-GRIP SUPERCUTTER®

- Adjustable grip
- Improved oil control
- Tap Wheel™ technology



FROM ONLY
£7.80*

GREAT VALUE

SALE PRICE EACH (INC. 10% DISCOUNT)

CAT. NO.	HEAD TYPE	DESCRIPTION	1	6	12
TC21PVR	140°	Cutter with pattern head	£14.50	£13.85	£11.85
TC21HSV	140°	Replacement straight head	£10.05	£9.60	£8.25
TC21HPV	140°	Replacement pattern head	£9.50	£9.10	£7.80

CRL TOYO® THOMAS-GRIP SUPERCUTTER®

- Self-oiling
- Unique grip ensures grip control and reduces strain



FROM ONLY
£9.95*

glasstec® SPECIAL

SALE PRICE EACH (INC. 10% DISCOUNT)

CAT. NO.	CUTTER MODEL	1	6	12
TC9SR	Wide head	£12.15	£11.65	£9.95
TC9PR	Pattern head	£12.15	£11.65	£9.95

CRL TOYO® PISTOL-GRIP SUPERCUTTERS®

- Pistol grip gives you more control and comfort
- New Tap Wheel™ technology gives you a better score and break for glass up to 19mm thick
- Smooth cutting action



FROM ONLY
£14.45*

AMAZING PRICES

SALE PRICE EACH (INC. 10% DISCOUNT)

CAT. NO.	CUTTER MODEL	1	6	12
TC600SVB	Tap Wheel™ thick glass cutter	£18.65	£17.80	£15.25
TC600PR	Rainbow handle 140° glass cutter	£17.70	£16.90	£14.45

CRL CLEANING PRODUCTS



Next Generation Surface Protection for Stainless Steel, Glass and Sandblasted Glass...



Stainless Steel and Glass - Pre Clean

- PC6010 100ml
- PC6025 250ml
- PC6050 500ml
- PC6100 1 Litre



Stainless Steel and Glass - Protect

- 6K6010 100ml
- 6K6025 250ml
- 6K6050 500ml
- 6K6100 1 Litre

6K by CRL is a two-step surface protection treatment with a 3 year protection lifespan.



Sandblasted Glass - Deep Clean

- 6KSBD660 660ml



Sandblasted Glass - Protect

- 6KSBP100 1 Litre
- 6KSBP050 500ml

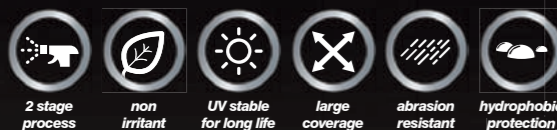

BEST SELLER

CRL Glass Cleaners

FROM ONLY **£1.35***

- Non-smear, fast acting
- Spray-on wipe-off, brilliant finish
- May be purchased with your label on can (CAT. NO. 1702/17022/17023)

SALE PRICE PER CAN (INC. 15% DISCOUNT)

CAT.NO	CAN SIZE	1	12	24	60	144
EB1701	660ml	-	£1.95	-	£1.69	£1.50
EB1701A	100ml	£1.59	-	£1.35	-	-

*Price based on quantity of 24 each (CAT.NO. EB1701A). Minimum order: 1 each of EB1701A; 12 each of EB1701.

CRL DELUXE SHOWER SQUEEGEE

- Perfect for cleaning glass, mirror, ceramic tile, and marble
- Suction hook holder requires no drilling
- 254mm blade
- Replacement blades available



ONLY **£12.65***

CAT. NO. 17600

*Minimum order: 1 each. Sale Price includes 10% discount

CRL OWN LABEL GLASS CLEANER

- Advertise your company
- Spray-on wipe-off, brilliant finish
- Sold per can, minimum order 600 cans



GREAT VALUE

SALE PRICE EACH (INC. 10% DISCOUNT)

CAT. NO.	DESCRIPTION	CONTENTS	600
1702	One colour print	660ml	£1.75
17022	Two colour print	660ml	£1.85
17023	Three colour print	660ml	£1.95

Minimum order: 600 cans. F.O.B. CRL service centre.

CRL REFRESH - STAINLESS STEEL REFRESHER/CLEANER



- Semi-permanent anti-finger print effect and stain elimination
- Removes grease and finger prints
- Coats the surface to help conceal against further every day marking
- Can be used as a cleaner (for pre-cleaning) and coating (for overlying stains)
- For structured or brushed stainless steel

FROM ONLY **£7.65***

SALE PRICE PER BOTTLE (INC. 10% DISCOUNT)

CAT. NO.	CONTENTS	1	6
CRLSSR010	100ML	£9.15	£7.65
CRLSSR025	250ML	£11.75	£9.65

*Price based on order quantity of 6 each (CAT. NO. CRLSSR010). Minimum order: 1 each.

CRL LINT FREE GLASS WIPES



- Strong, white four-ply paper wipes are virtually lint-free
- Reinforced nylon scrim in both directions so they work great wet or dry
- Convenient pop-up dispenser box

FROM ONLY **£9.25***

GREAT VALUE

SALE PRICE EACH (INC. 10% DISCOUNT)

CAT. NO.	CONTAINER	1	5	6	10
BX15	Box of 150 lint-free wipes	£10.20	-	£9.25	-
1550	Case of 900 lint-free wipes	£53.00	£49.00	-	£45.50

*Price based on order quantity of 6 each (CAT. NO. BX15). Minimum order: 1 container.

Safety wear



CRL POWERFLEX KEVLAR GLOVES

- Available in three sizes
- Tested BS EN 388
- Rating 4544

FROM ONLY **£5.95***



SALE PRICE PER PAIR (INC. 10% DISCOUNT)

CAT. NO.	SIZE	1	20
0625A	Small	£7.45	£5.95
0626A	Medium	£7.45	£5.95
0627A	Large	£7.45	£5.95

*Price based on order quantity of 20 pairs. Minimum order: 1 pair. Sizes can be combined for quantity pricing.

CRL SAFETY GLOVES

CRL YELLOW CRISS CROSS GLOVES

- Seamless knitted construction with an elastic wrist
- Coated with a clear, soft PVC criss cross pattern on both sides

CRL KNIT WRIST/GAUNTLET CUFF GLASS HANDLING GLOVES

- Flexible and smooth rubber coating for glass use
- Very comfortable fit

SALE PRICE PER PAIR (INC. 10% DISCOUNT)

CAT. NO.	DESCRIPTION	1	12	20	24	72
0629	Criss cross gloves	£0.75	-	£0.60	-	-
0606	Gristle gloves	£2.20	-	£1.75	-	-
SG10	Knit wrist gloves	£3.35	£3.10	-	£2.80	£2.60
SG12	Gauntlet cuff gloves	£4.10	£3.75	-	£3.40	£3.15

*Minimum order: 1 pair. Sizes can be combined for quantity pricing.



0629
Criss Cross Gloves



0606
Gristle Gloves



SG10
Knit Wrist Gloves



SG12
Gauntlet Cuff Gloves

CRL CUT PROTECTION POLO SHIRT

- Maximum cut and puncture resistance
- Offers both style and comfort
- Cordura® material reinforcement in the belly area
- Front and back are made from Coolmax

FROM ONLY **£87.30***

SALE PRICE EACH (INC. 10% DISCOUNT)

CAT. NO.	SIZE	1	6
993898MD	Medium	£94.50	£87.30
993898LG	Large	£94.50	£87.30
993898XL	Extra large	£94.50	£87.30

*Price based on order quantity of 6 each. Minimum order: 1 each. Sizes can be combined for quantity pricing.



CRL CUT RESISTANT WRIST GUARDS

FROM ONLY **£9.80***

- Our best value Wrist Guards
- Velcro fastening
- BS EN 388 X-5-X-3



SALE PRICE PER PAIR (INC. 10% DISCOUNT)

CAT. NO.	DESCRIPTION	1	12	24
0601	Cut Resistant Wrist Guards	£11.90	£10.35	£9.80

*Price based on order quantity of 24 pairs. Minimum order: 1 pair.

CRL HEATED MIRROR PADS

- Prevents mirror misting
- Simple installation
- Applied to back of mirror
- Made in Europe
- 240 Volts

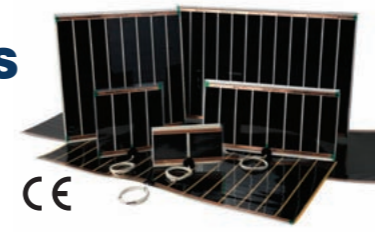

SALE PRICE EACH (INC. 10% DISCOUNT)

CAT. NO.	SIZE	1	10	100
7020MP	584mm x 274mm	£16.10	£13.80	£12.85
7030MP	524mm x 520mm	£22.70	£19.50	£18.20
7035MP	785mm x 524mm	£28.15	£24.10	£22.50
7040MP	1040mm x 524mm	£34.25	£29.40	£27.45
7050MP	1505mm x 524mm	£49.95	£42.85	£40.05

Minimum order: 1 each. Sizes can be combined for quantity pricing.

CRL ED SERIES MIRROR MOUNTING SET

- Press button mirror mounting set including eccentric discs, press buttons, mirror plates, self-adhesive pads, screws, and wall plugs
- Easy installation
- Fixings hidden from sight
- Suitable for mirror surfaces up to 0.8m², 1.6m², and 2.6m²
- Suitable for wet rooms

SALE PRICE PER SET (INC. 10% DISCOUNT)

CAT. NO.	SIZE	1	24	48
P19ED08	0.8m ² Mirror Surface	£3.80	£3.55	£2.75
P19ED16	1.6m ² Mirror Surface	£4.95	£4.45	£3.45
P19ED26	2.6m ² Mirror Surface	£7.15	£6.45	£5.00

Each set includes: P19ED08/P19ED16: 2 each eccentric discs, 2 each press buttons, 2 each mirror plates. P19ED26: 3 each eccentric discs, 2 each press buttons, 3 each mirror plates.

*Price based on order quantity of 48 each (CAT. NO. P19ED08). Minimum order: 1 each.

CRL EM SERIES MIRROR MOUNTING SET

- Magnet mirror mounting set including eccentric discs, mirror-adhesive magnets, mirror plates, self-adhesive pads, screws, and wall plugs
- Easy installation
- Fixings hidden from sight
- Suitable for mirror surfaces up to 0.8m², 1.6m², and 2.6m²
- Suitable for wet rooms

SALE PRICE PER SET (INC. 10% DISCOUNT)

CAT. NO.	SIZE	1	24	48
P19EM08	0.8m ² Mirror Surface	£5.25	£4.75	£3.65
P19EM16	1.6m ² Mirror Surface	£5.70	£5.15	£3.95
P19EM26	2.6m ² Mirror Surface	£7.35	£6.60	£5.10

Each set includes: P19EM08/P19EM16: 2 each eccentric discs, 2 each mirror-adhesive magnets, 2 each mirror plates. P19EM26: 3 each eccentric discs, 2 each mirror-adhesive magnets, 3 each mirror plates.

*Price based on order quantity of 48 each (CAT. NO. P19EM08). Minimum order: 1 each.

CRL LD SERIES MIRROR MOUNTING SET

- Simple mirror mounting bracket set including press buttons, mounting brackets, mirror plates, self-adhesive pads, screws, washers, and wall plugs
- Easy installation
- Fixings hidden from sight
- Suitable for mirror surfaces up to 0.8m², 1.6m², and 2.6m²
- Suitable for wet rooms

SALE PRICE PER SET (INC. 10% DISCOUNT)

CAT. NO.	SIZE	1	24	48
P19LD08	0.8m ² Mirror Surface	£4.25	£3.85	£2.95
P19LD16	1.6m ² Mirror Surface	£5.25	£4.75	£3.65
P19LD26	2.6m ² Mirror Surface	£7.65	£6.90	£5.30

Each set includes: P19LD08/P19LD16: 2 each mounting brackets, 2 each mirror plates, 2 each press buttons. P19LD26: 3 each mounting brackets, 3 each mirror plates, 2 each press buttons.

*Price based on order quantity of 48 each (CAT. NO. P19LD08). Minimum order: 1 each.

CRL E-Z MOUNT MIRROR CLIP SETS

- The fast and secure way to hang mirrors
- For 4mm and 6mm glass
- Made of nickel plated steel
- Upper clips - have unique, spring loaded flanges. Expand these clips during installation, it's quick and easy!
- Lower clips - always remain stationary and have a 7.9mm channel space

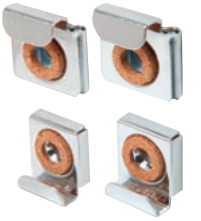

SALE PRICE PER SET (INC. 10% DISCOUNT)

CAT. NO.	DESCRIPTION	1	50	100	250	1000
655	Set of 4 Clips	£1.35	£1.25	£1.10	£1.05	£1.00

Minimum order: 1 set.

NOTE: Maximum recommended mirror size is 914 x 1219mm



FROM ONLY **£2.75***

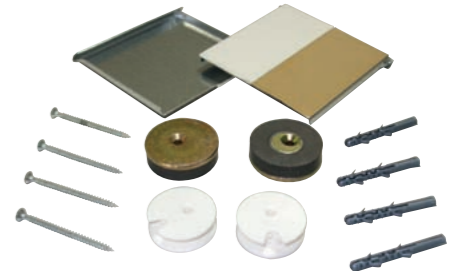

FROM ONLY **£3.65***

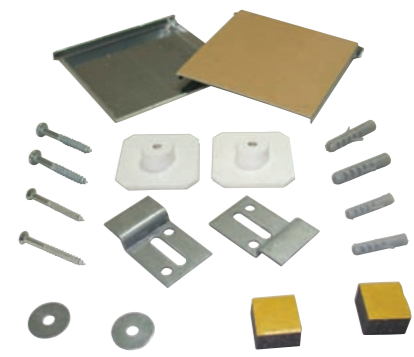

FROM ONLY **£2.95***

Detect It!

CRL is pleased to offer a comprehensive range of Detectors at fantastic prices!



GREAT PRICES



CD1

CRL CONDUCTIVE COATING DETECTOR

- Red indicator lights up on contact with Low-E
- Edge stop restricts use to edge of glass, prevents scratching
- Small enough to fit in your shirt pocket

SALE PRICE EACH (INC. 10% DISCOUNT)

CAT. NO.	DESCRIPTION	1
CD1	Conductive coating detector	£20.85

Minimum order: 1 each.



CD2

CRL NON-CONTACT DETECTOR

- Single button activation
- Visual red LED indicator and audible signal announces coating found
- Helps assure manufacturers and customers that coating is present
- Slips comfortably into shirt pocket

SALE PRICE EACH (INC. 10% DISCOUNT)

CAT. NO.	DESCRIPTION	1
CD2	Non-contact detector	£49.45

Minimum order: 1 each.



CD3

CRL DUAL PURPOSE DETECTOR

- Switches between direct contact and non-contact modes
- Visual and audible signals indicate Low-E presence
- Maintains calibration at all times
- Compact, reliable, and efficient

SALE PRICE EACH (INC. 10% DISCOUNT)

CAT. NO.	DESCRIPTION	1
CD3	Dual purpose detector	£59.35

Minimum order: 1 each.

CRL GLASS-CHEK ELITE

- Identifies laminated glass in a window
- Measures the thickness of the laminate inner-layer
- Graphical display that shows an illustration of the profile of the window, helping the user to better understand the construction of the window
- It can even identify which piece of glass has the Low-e coating, when the Low-e surface is placed against the laminate inner-layer
- It has all the abilities of Glass-Chek PRO as well, including the ability to measure window thickness and identify the presence of Low-e coatings

NEW



CAT. NO. GC3200

CRL METRIC SCALE GLASS THICKNESS LASER

- Measures from inside of the building- no glass removal is necessary
- Calculates thicknesses of insulating glass, laminated, bullet-resistant, and single lite float glass
- Padded carrying case and batteries included
- Provides metric measurements

ONLY
£199.00*

CAT. NO. MG1500MM

glasstec® SPECIAL

SAVE
£25.00

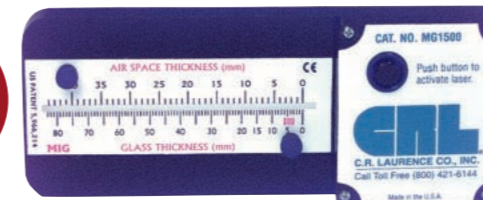

CRL SOLAR TRANSMISSION AND BTU POWER METER

- Demonstrate your products solar performance
- Displays solar transmission and BTU power readings
- Easily switches to BTU measurements

glasstec® SPECIAL

ONLY
£129.00*

CAT. NO. SP2065

SAVE
£20.00



CRL GLASS-CHEK PRO

- Triple pane thickness measurement
- Full Low-e detection capabilities
- Enhanced compatibility means more applications

BEST SELLER

ONLY
£732.00*

CAT. NO. GC3000

SAVE
£50.00



CRL COMMERCIAL TIN SIDE DETECTOR

- The solution glass processors have been waiting for
- More rugged design
- Definitive test results
- Momentary power switch helps conserve energy
- Pulse the power on and off making it easier to identify the milky white glow when placed on the tin side of glass

SAVE
£15.00

glasstec® SPECIAL

ONLY
£143.65*

CAT. NO. TS1320

GREAT VALUE



CRL BTU DIGITAL SOLAR POWER METER

- Solar power readings in BTUs/Hr-FT²
- Digital modern-day technology
- Identify high performance windows

glasstec® SPECIAL

ONLY
£105.00*

CAT. NO. SP1065

SAVE
£10.00



*Minimum order: 1 each. Sale prices include discount.

CRL DIGITAL TIN SIDE DETECTOR

SAVE £20.00

- Digital technology
- Easy-to-read meter
- UV lamp is not required
- Identifies the tin side of float glass

glasstec® SPECIAL

ONLY £151.50*

CAT. NO. TS2300

Lowest Price Guaranteed!



CRL STRENGTHENED GLASS DETECTOR

- Identifies heat-strengthened glass
- Indicates thickness of the first pane of glass
- Tests single or double panes

glasstec® SPECIAL

SAVE £30.00

ONLY £239.00*

CAT. NO. SG2700



CRL WINDOW ENERGY PROFILER

- Tests windows in frame without removal
- Simultaneously displays percentage of allowable uv transmission, percentage of visible light, percentage of infrared light transmission, and solar heat gain co-efficient
- Completely portable with convenient handle for taking measurements
- Convenient carrying case included

glasstec® SPECIAL

ONLY £547.95*

CAT. NO. WP4500



SAVE £50.00

CRL UV LAMP TIN SIDE DETECTOR

- Battery powered UV lamp identifies the tin side of float glass

SAVE £10.00

ONLY £72.50*

CAT. NO. UVG4



NOTE: Requires 4 "AA" batteries, which are not included.

glasstec® SPECIAL

UV Adhesives

The technological development of UV Glass Bonding over the years has enabled us to present a range of adhesives with a unique combination of performance, design, and processing benefits.

There's even more in our specialist Glass Bonding System Catalogues.

Order your copy at crlaurence.co.uk



CRL UV601 LOW VISCOSITY UV ADHESIVE

- Ideal for glass-to-glass bonding
- Capillary action
- Optically clear

FROM ONLY £6.60*



Lowest Price Guaranteed!

SALE PRICE EACH (INC. 15% DISCOUNT)

CAT. NO.	NET WEIGHT	1	3
UV60130	30g	£7.25	£6.60
UV60110	100g	£18.25	£16.60

*Price based on order quantity of 3 (CAT. NO. UV60130). Minimum order: 1 each.

CRL TRANSPARENT UV614 MEDIUM VISCOSITY UV ADHESIVE

- Solvent free - environmentally friendly with 100% solids in cured state
- Even force build-up prevents detrimental stress peaks
- One component adhesive, no mixing, no pot life and therefore no time limit for processing
- Same refractive index as glass for invisible bonded joints
- Good resistance to temperature, chemicals and humidity - resistant to yellowing



FROM ONLY £9.95^Δ

SALE PRICE EACH (INC. 15% DISCOUNT)

CAT. NO.	NET WEIGHT	1	3
UV61410	100g	£10.95	£9.95

^ΔPrice based on order quantity of 3. Minimum order: 1 each.

YOU MAY ALSO NEED...

CRL PYROSIL ADHESION PRETREATMENT KIT CAT. NO. UVFB25K1T



CRL UV602 UV/VISIBLE LIGHT ADHESIVE

- Bonds laminated glass UV and visible light cure
- Medium viscosity with capillary action
- Optically clear
- Best adhesion to plastics



FROM ONLY £16.35^Δ

SALE PRICE EACH (INC. 15% DISCOUNT)

CAT. NO.	NET WEIGHT	1	3
UV602L85	85g	£17.95	£16.35

^ΔPrice based on order quantity of 3. Minimum order: 1 each.

CRL UV604 MEDIUM VISCOSITY UV/VISIBLE LIGHT ADHESIVE

- Especially strong glass to metal bonds
- UV and visible light cure
- Medium viscosity
- Optically clear



GREAT VALUE

FROM ONLY £16.80^Δ

SALE PRICE EACH (INC. 15% DISCOUNT)

CAT. NO.	NET WEIGHT	1	3
UV604L10	100g	£18.50	£16.80

^ΔPrice based on order quantity of 3. Minimum order: 1 each.

CRL E.Z.D. GLAZER DE-GLAZING TOOL

- Aids in the de-glazing of glass installed with silicone, foam tapes, butyl tapes and other flexible materials
- Blade lays flat on the glass and slides into the glazing pocket
- Extremely simple-to-use
- Built-in knuckle protector lets you work right next to the glass for good leverage and a deep cut when needed

FROM ONLY £34.35*

SALE PRICE EACH (INC. 10% DISCOUNT)

CAT. NO.	DESCRIPTION	1	6
EZ1010	E.Z.D. glazer de-glazing tool	£35.65	£34.35
EZ1022	Screw-on replacement blade	£15.75	-

*Price based on order quantity of 6 (CAT. NO. EZ1010).



CRL FACE CAP REMOVER

- Makes it easy to remove most pressure bar system face caps
- Quickly adjusts to varying size face caps
- Lightweight and easy to grip handle

NEW

ONLY £26.00

CAT. NO. FCR1



*Minimum order: 1 each. Sale prices include discount.

Silicones and Adhesives



CRL GLAZING AND CONSTRUCTION SILICONE SEALANT

- Low modulus, low odour, neutral cure formula construction and glazing sealant
- Excellent adhesion to most surfaces
- Conforms to ISO 11600
- 305ml cartridge
- 12 per case



GREAT VALUE

FROM ONLY £1.35*

SALE PRICE PER CARTRIDGE (INC. 10% DISCOUNT)

CAT.NO	COLOUR	1	12	120	240
EURTV408C	Clear	£1.55	£1.45	£1.40	£1.35
EURTV408W	White	£1.55	£1.45	£1.40	£1.35
EURTV408BL	Black	£1.55	£1.45	£1.40	£1.35
EURTV408G	Grey	£1.55	£1.45	£1.40	£1.35
EURTV408BR	Brown NEW	£1.55	£1.45	£1.40	£1.35

*Price based on order quantity of 240 (EURTV408 series silicones). Minimum order: 1 each. Sealants can be combined for quantity pricing.

CRL evergrip™ eg310 MIRROR ADHESIVE

- Extra fast grabbing mirror adhesive
- Extra strong holding capacity
- Fast curing, with skin formation in about five minutes
- Adhesion to almost all surfaces
- Low VOC, solvent free, low odour
- 310ml cartridge
- 12 per case



FROM ONLY £1.69*

SALE PRICE PER CARTRIDGE (INC. DISCOUNT)

CAT. NO.	12	60	120	240
EG310	£1.99	£1.89	£1.79	£1.69

*Price based on order quantity of 240 (CAT. NO. EG310). Minimum order: 12 each. Sealants can be combined for quantity pricing.

CRL eg310ULTRA COMPLETE ADHESIVE

- Instant grab, with fantastic holding capacity: 20kgs/cm²
- Neutral curing and odourless, cures with atmospheric moisture
- Recommended for internal and external use
- Super-fast bonding of mirrors, glass, wood, composite panels, and metal, to a range of substrates
- 290ml cartridge
- 12 per case



INSTANT GRAB

FROM ONLY £3.69*

SALE PRICE PER CARTRIDGE (INC. 10% DISCOUNT)

CAT. NO.	12	60	120	240
EG310ULTRA	£4.40	£4.10	£3.90	£3.69

*Price based on order quantity of 240 (CAT. NO. EG310ULTRA). Minimum order: 12 each. Sealants can be combined for quantity pricing.

CRL ACETIC CURE SILICONE SEALANT

- Acetic cure formula
- Plastic cartridges with screw-on nozzles
- 300ml cartridge
- 12 per case



FROM ONLY £1.35*

PRICE PER 300ML CARTRIDGE

CAT.NO	COLOUR	1	12	120	240
EU33SC	Clear	£1.55	£1.45	£1.40	£1.35
EU33SW	White	£1.55	£1.45	£1.40	£1.35
EU33SBL	Black	£1.55	£1.45	£1.40	£1.35

*Price based on order quantity of 240. Minimum order: 1 each. Sealants can be combined for quantity pricing.

CRL SMOOTH ROD CAULKING GUN

- Thumb pressure release button
- Our best seller is also a great value
- Perfect for low viscosity materials



FROM ONLY £1.95*

GREAT VALUE

SALE PRICE EACH (INC. 10% DISCOUNT)

CAT. NO.	DESCRIPTION	1	12
ER3	Smooth rod caulking gun	£2.15	£1.95

*Price based on order quantity of 12 each. Minimum order: 1 each. All caulking guns can be combined for quantity pricing.

CRL CRYSTAL CLEAR SILICONE SEALANT

- Optically clear when cured
- Applications include shower enclosures and specialty glass assemblies
- Environmentally friendly
- 310ml cartridges, 12 per case
- Temperature resistant -40/+120 degrees Celsius



FROM ONLY £1.75*

SALE PRICE EACH (INC. 10% DISCOUNT)

CAT. NO.	DESCRIPTION	1	12	120	240
EUCCS	310ml	£1.95	£1.85	£1.80	£1.75

*Price based on order quantity of 240. Minimum order: 1 each. Sealants can be combined for quantity pricing.

CRL METAL STRAP FRAME CAULKING GUN

- Popular strap frame design
- Smooth rod with thumb release



FROM ONLY £4.90*

glasstec® SPECIAL

SALE PRICE EACH (INC. 15% DISCOUNT)

CAT. NO.	DESCRIPTION	1	12
GA1204	Metal strap frame caulking gun	£5.30	£4.90

*Price based on order quantity of 12 each. Minimum order: 1 each. All caulking guns can be combined for quantity pricing.

65KG LIFTING CAPACITY

CRL S338 SURE-GRIP® VACUUM LIFTER

- Greatest lifting capacity of any 203mm pump activated vacuum lifter
- One hand pump and attachment for safety when needed
- Superior "press-and-pump" attachment feature
- Built-in vacuum loss indicator
- Soft contoured sure-grip handle for comfort

CAT. NO.	DESCRIPTION	PRICE EACH		
		1	4	10
S338	Sure-Grip® 203mm Vacuum Lifter	£29.50	£28.50	£27.50

*Price based on order quantity of 10 each. Minimum order: 1 each. All CRL Vacuum Lifters can be combined for quantity pricing.

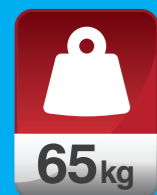

CONVENIENT VACUUM INDICATOR



SUPERIOR COMFORT AND GRIP



FAST RELEASE



EVEN MORE GREAT PRODUCTS

VISIT crlaurence.co.uk and view CAT. NO. GG2014A

FROM ONLY **£27.50***



CRL S108 PUMP-ACTION VACUUM LIFTER

- 203mm diameter pad
- Proven reliability throughout the world
- Heavy-duty 5mm thick ABS handle resists bending, especially during heavy lifts
- Fast, safe attachment to smooth, non-porous flat surfaces
- Four extra mounting points make it easy to attach to metal lifting frames, jigs, and our vacuum ratchet tensioning kit
- 56kg lifting capacity



FROM ONLY **£27.50***

CAT. NO.	DESCRIPTION	PRICE EACH		
		1	4	10
S108	203mm pump-action vacuum lifter	£29.50	£28.50	£27.50

*Price based on order quantity of 10 each. Minimum order: 1 each. All CRL Vacuum Lifters can be combined for quantity pricing.

CRL S110 PUMP-ACTION VACUUM LIFTER FOR FLAT SURFACES

- Large 254mm diameter pad
- Designed to carry large sheets of glass, marble or stone safely
- Supplied with protective carrying case
- Providing safe lifting to the industries since 1992
- Red-line indicator warns user of any vacuum loss
- 80kg lifting capacity



FROM ONLY **£40.50***

SALE PRICE EACH (INC. 10% DISCOUNT)

CAT. NO.	DESCRIPTION	PRICE EACH		
		1	4	10
S110	254mm vacuum lifter for flat surfaces	£45.00	£42.75	£40.50

*Price based on order quantity of 10 each. Minimum order: 1 each. All CRL Vacuum Lifters can be combined for quantity pricing.

CRL WOOD'S POWR-GRIP® 203MM ABS HANDLE VACUUM CUP

- Durable handle
- Fast attachment on smooth, non-porous flat surfaces
- Check valve allows re-pumping without loss of remaining vacuum
- Release valve lever permits quick and complete release
- Red-line indicator warns user of any vacuum loss
- 57kg lifting capacity



FROM ONLY **£28.00***

CAT. NO.	DESCRIPTION	PRICE EACH		
		1	4	10
W4000	POWR-Grip® 203mm Vacuum Cup	£29.99	£29.00	£28.00

*Price based on order quantity of 10 each. Minimum order: 1 each. All Wood's Vacuum Cups can be combined for quantity pricing.

CRL S109 PUMP-ACTION VACUUM LIFTER

- 203mm diameter pad
- Designed primarily for lifting curved architectural glass
- Excellent also for thin, flexible materials
- Red-line indicator warns user of any vacuum loss
- Moulded carrying case
- 56kg lifting capacity



FROM ONLY **£31.00***

CAT. NO.	DESCRIPTION	PRICE EACH		
		1	4	10
S109	203mm vacuum lifter for curved surfaces	£35.00	£33.00	£31.00

*Price based on order quantity of 10 each. Minimum order: 1 each. All CRL Vacuum Lifters can be combined for quantity pricing.

CRL S7950 STEEL HANDLE PUMP-ACTION VACUUM LIFTER

- 203mm vacuum pad
- Heavy-duty stainless steel handle
- Fast attachment on smooth, non-porous flat surfaces
- Can be re-pumped without losing remaining vacuum
- Tough ABS plunger with red-line indicator
- Full pad face contact when pumped reduces distortion
- Wide release valve lever with safety guard permits quick and complete release
- 57kg lifting capacity



SAVE **£4.00**
FROM ONLY **£34.75***

SALE PRICE EACH (INC. DISCOUNT)

CAT. NO.	DESCRIPTION	PRICE EACH	
		1	4
S7950	203mm pump-action vacuum lifter	£38.65	£34.75

*Price based on order quantity of 4 each. Minimum order: 1 each. All CRL Vacuum Lifters can be combined for quantity pricing.

CRL WOOD'S POWR-GRIP® 203MM METAL HANDLE VACUUM CUP

- Durable metal handle
- Fast attachment on smooth, non-porous flat surfaces
- Red-line indicator warns user of any vacuum loss
- Check valve allows re-pumping without loss of remaining vacuum
- Release valve lever permits quick, complete release
- 57kg lifting capacity



SAVE **£4.00**
FROM ONLY **£43.50***

SALE PRICE EACH (INC. DISCOUNT)

CAT. NO.	DESCRIPTION	PRICE EACH	
		1	4
W4950	POWR-Grip® 203mm vacuum cup	£47.40	£43.50

*Price based on order quantity of 4 each. Minimum order: 1 each. All Wood's Vacuum Cups can be combined for quantity pricing.

Move it...

CRL Glasstrax Glass Dolly

- Safe glass transport with large 272kg capacity
- Self clamping action locks loads up to 50.8mm thick
- One person can load and manoeuvre

SALE PRICE
£295.00*
EACH

*Minimum order: 1 each. Sale price includes discount.



CRL All Terrain Dolly

- Terrific for moving heavy glass panels and stone slabs around the job site
- Goes where other dollies won't
- Built-In 203mm Wood's™ POWR-Grip® Vacuum Cup
- Includes a set of our RB200 Roller Blocks

ONLY
£375.00*

*Price based on order quantity of 1 each. Minimum order: 1 each. Sale price includes discount.

glasstec® SPECIAL
SAVE £40.00

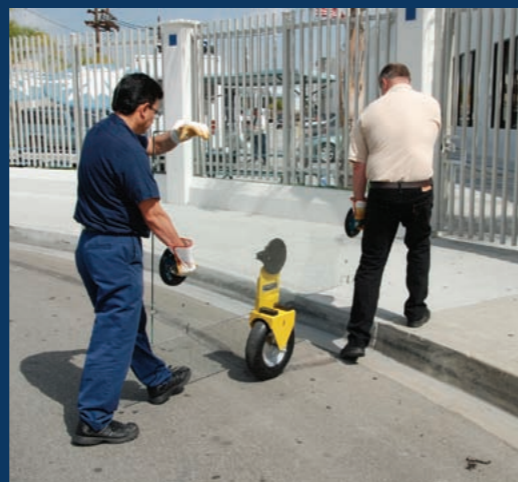

CRL SUCTION LIFTERS

MAXIMUM PERFORMANCE
MAXIMUM VALUE

AMAZING PRICES

glasstec® SPECIALS

CRL SINGLE PAD SUCTION LIFTER

- Compact design
- One-handed operation
- 30kg lifting capacity



FROM ONLY
£22.50*

SALE PRICE EACH (INC. 10% DISCOUNT)

CAT. NO.	DESCRIPTION	1	6
05061	Single pad suction lifter	£25.30	£22.50

*Price based on order quantity of 6 each. Minimum order: 1 each. All suction lifters can be combined for quantity pricing.

CRL DOUBLE PAD SUCTION LIFTER

- Handle design allows easy maneuvering
- Strong, lightweight aluminium
- 60kg lifting capacity



FROM ONLY
£25.15*

SALE PRICE EACH (INC. 10% DISCOUNT)

CAT. NO.	DESCRIPTION	1	6
05062	Double pad suction lifter	£28.25	£25.15

*Price based on order quantity of 6 each. Minimum order: 1 each. All suction lifters can be combined for quantity pricing.

CRL TRIPLE PAD SUCTION LIFTER

- Three suction pads individually operated
- Strong, lightweight aluminium
- 100kg lifting capacity



FROM ONLY
£29.40*

SALE PRICE EACH (INC. 10% DISCOUNT)

CAT. NO.	DESCRIPTION	1	6
05063	Triple pad suction lifter	£34.65	£29.40

*Price based on order quantity of 6 each. Minimum order: 1 each. All suction lifters can be combined for quantity pricing.

CRL MOVABLE DOUBLE PAD SUCTION LIFTER

- Movable pads self-adjust to curved glass
- Suitable for glass, plastic, metal, coated wood, marble, and any other smooth, airtight surface
- 60kg lifting capacity



FROM ONLY
£29.40*

SALE PRICE EACH (INC. 10% DISCOUNT)

CAT. NO.	DESCRIPTION	1	6
05064	Movable double pad suction lifter	£34.65	£29.40

*Price based on order quantity of 6 each. Minimum order: 1 each. All suction lifters can be combined for quantity pricing.

SUPPORT BARS

ROUND SUPPORT BARS AND ACCESSORIES AVAILABLE

- Square tubing matches geometry of many popular CRL hinges
- Provides fixed panel support for enclosures not going to the ceiling
- No hole drilling required in glass

Our Square Support Bar complements many CRL square corner style hinges. The Bar stabilizes fixed panels of glass in enclosures that do not go to the ceiling. After ordering the Bar itself, choose from a number of various fittings to complete the desired application. The Fittings come with nylon-tipped set screws that secure the glass and prevent metal-to-metal contact. Finishes are available to match many popular decors. No holes or cut-outs are required in the glass.

SPECIFICATIONS:

Materials: 19mm Square Tubing, Solid Brass Fittings
Bar Length: 1.5m
Glass Thickness Range: 6 to 12mm



FINISHES



XX = Finish Designation
 ie: **SQ59CH** = Polished Chrome



CAT. NO. SQ59CH
 1.5m Square Bar
PRICE FROM £33.05*



CAT. NO. SQ41CH
 Swiveling U-Bracket for 6 to 8mm Glass for Square Bar
PRICE FROM £9.95*



CAT. NO. SQ42CH
 Swiveling U-Bracket for 10 to 12mm Glass for Square Bar
PRICE FROM £9.95*



CAT. NO. SQ43CH
 Movable Bracket for 6 to 8mm Glass for Square Bar
PRICE FROM £6.05*



CAT. NO. SQ44CH
 Movable Bracket for 10 to 12mm Glass for Square Bar
PRICE FROM £6.05*



CAT. NO. SQ50CH
 "T" Junction Bracket for Square Bar
PRICE FROM £11.75*



CAT. NO. SQ45CH
 Adjustable Corner Bracket for Square Bar
PRICE FROM £14.85*



CAT. NO. SQ46CH
 Wall Mount Bracket for Square Bar
PRICE FROM £5.80*



CAT. NO. SQ47CH
 45° Mitered Wall Mount Bracket for Square Bar
PRICE FROM £7.75*



CAT. NO. SQ48CH
 22.5° Mitered Wall Mount Bracket for Square Bar
PRICE FROM £9.75*



CAT. NO. SQ49CH
 Adjustable Wall Mount Bracket for Square Bar
PRICE FROM £13.85*

*Prices based on order quantity of 6 and 'CH' Polished Chrome finish.

CRL DELUXE SERENITY SERIES SLIDING SHOWER DOOR SYSTEM

CAT. NO. SER78BS BRUSHED STAINLESS DELUXE 180 DEGREE KIT
 CAT. NO. SER78PS POLISHED STAINLESS DELUXE 180 DEGREE KIT

Deluxe 180 Degree Kit Includes:

- 1 - 2m length header support bar
- 4 - Rollers
- 1 - Stopper
- 2 - Track holder fittings for wall
- 2 - Track holder fittings for fixed panel
- 1 - Thru-glass pull
- 1 - Door guide
- 1 - 2.16m length clear L-jamb

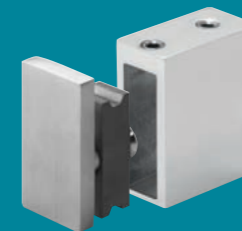

Images shown here (CAT. NO.'s SER90BS and SERAHW2BS)

FROM ONLY **£173.25***

CAT. NO.	DESCRIPTION	FINISH	PRICE EACH	
			1	6
SER78BS	Deluxe 180 Degree Serenity Kit	Brushed Stainless	£190.55	£173.25
SER78PS	Deluxe 180 Degree Serenity Kit	Polished Stainless	£205.90	£187.25
SER90BS	90 Degree Accessory Kit	Brushed Stainless	£5.90	£5.35
SER90PS	90 Degree Accessory Kit	Polished Stainless	£6.20	£5.65
SERAHW2BS	Track Holder Fittings for Wall	Brushed Stainless	£16.50	£14.90
SERAHW2PS	Track Holder Fittings for Wall	Polished Stainless	£19.15	£17.25

* Price based on order quantity of 6 (CAT. NO. SER78BS).
 Minimum order: 1 each. Finishes can be combined for quantity pricing.
 90 degree accessory kit sold separately. Glass not included.

CRL HYDROSLIDE SLIDING SHOWER DOOR KITS

CAT. NO. HYDK60CH BRITE ANODISED/CHROME 180 DEGREE STANDARD KIT 1524MM
 CAT. NO. HYDK84CH BRITE ANODISED/CHROME 180 DEGREE STANDARD KIT 2134MM

Standard 180 Degree Kit Includes:

- 1 - Sliding glass door upper track
- 2 - Hangers for sliding glass door
- 2 - Sliding glass door rollers
- 2 - Sliding glass door roller stops
- 1 - Sliding glass door floor guide (HYD03)
- 2 - 90° wall-to-upper track connectors
- 2 - 180° glass-to-sliding track connectors
- 1 - 0.91m length half-round SDT980 threshold
- 1 - 2.49m length DK98L L-seal for wall

FROM ONLY **£125.15***

CAT. NO.	DESCRIPTION	FINISH	SALE PRICE EACH (INC. 10% DISCOUNT)	
			1	6
HYDK60CH	Standard 180° kit 1524mm	Brite anodised/chrome	£137.65	£125.15
HYDK84CH	Standard 180° kit 2134mm	Brite anodised/chrome	£150.45	£136.75
HYDA9CH	90° Wall-to-glass accessory kit	Brite anodised/chrome	£38.40	£34.95
HYDK60BN	Standard 180° kit 1524mm	Brushed nickel	£156.60	£142.40
HYDK84BN	Standard 180° kit 2134mm	Brushed nickel	£167.20	£152.00
HYDA9BN	90° Wall-to-glass accessory kit	Brushed nickel	£44.85	£40.85

* Price based on order quantity of 6 (CAT. NO. HYDK60CH).
 Minimum order: 1 each. Finishes can be combined for quantity pricing.
 90 degree accessory kit sold separately. Glass not included.



Softly, softly.

Introducing the CABO Soft Slide Sliding Shower Door System

We are delighted to offer our leading 'softbrake' braking system on a frameless sliding shower door. 'Softbrake' cushions the opening and closing of the door gently, quietly, and is completely concealed inside the header.

If it's not CABO, it's not double soft close.

Square clamp shown on sliding panel

Bottom floor guide included

- Featuring the new 'softbrake' braking system
- Hardware for one sliding door and one fixed panel
- Concealed overhead roller design
- Mounts wall-to-wall or wall-to-glass
- For use with 8, 10 or 12mm toughened glass (not included)
- Can accommodate doors weighing up to 80kg
- Available in five stock architectural finishes

The CABO Soft Slide Sliding Shower Door System is the first to offer the 'softbrake' braking system on a frameless sliding shower door, ensuring that you do not have to worry about the door slamming open or closed. 'Softbrake' cushions the opening and closing of the door gently, quietly, and is completely concealed inside the header. 'Softbrake' engages during the last 100mm of door travel, preventing the glass from impacting the frame or adjacent glass panel.

Each CABO 180 degree soft slide sliding door kit comes complete with a header, two top clamps, a bottom guide, a wall seal and a half-round threshold.

Bottom fixed glass attachments, handles, knobs and the 90 degree return hardware kit must be ordered separately. Our complete line of CABO soft slide sliding door kits and accessories can be seen at crlaurence.co.uk

FROM ONLY
£506.75*



CAT. NO. CABS84CH
Square
Clamp Style



CAT. NO. CABR84CH
Rounded
Clamp Style

Specifications:

Material: Anodised aluminium

Overall shower width: Maximum 2.13m wide, minimum 1.52m wide

Fabrication: Holes required in sliding door

Includes: Gaskets, screws, and glass fabrication information

Other finishes available:

Satin Anodized, Brushed Nickel, Polished Brass, Duranodic Bronze.

See crlaurence.co.uk for door weight and width requirements.

CAT.NO. CAB90CH
90° return hardware kit
(shown here) includes return
bracket and wall clamp.



CAT. NO.	DESCRIPTION	FINISH	PRICE EACH	
			1	6
CABR84CH	2.13m 180 degree kit with header	Polished chrome	£572.45	£520.70
CABS84CH	2.13m 180 degree kit with header	Polished chrome	£557.15	£506.75
CAB90CH	90 degree return hardware kit	Polished chrome	£245.95	£223.70

*Price based on order quantity of 6 each (CAT. NO. CABS84CH).
Minimum order: 1 each. Finishes can be combined for quantity pricing.
90 degree hardware kit sold separately. Glass not included.

Offer prices valid from 01-10-14 to 31-01-15

Email: crl@crlaurence.co.uk | crlaurence.co.uk

AMAZING PRICES ON U-CHANNELS



CRL ALUMINIUM U-CHANNEL FOR 8MM-10MM GLASS

- 19mm high profile
- May be used alone or with regular depth U-Channel
- Wet glazed with clear silicone to secure glass
- Available in 17 finishes - see crlaurence.co.uk
- Matching end caps sold separately



FROM ONLY **£7.20***

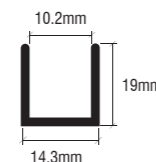

SALE PRICE EACH (INC. 10% DISCOUNT)

CAT. NO.	FINISH	LENGTH	1	10	40
SDCD38BA	Brite Anodised	2.49m	£9.90	£7.90	£7.20
SDCD38BN	Brushed Nickel	2.49m	£10.65	£8.55	£7.75
SDCD3812BA	Brite Anodised	3.65m	£17.25	£15.30	£13.75
SDCD3812BN	Brushed Nickel	3.65m	£20.15	£17.90	£16.15

*Price based on order quantity of 40 (CAT. NO. SDCD38BA). Minimum order: 1 each. All u-channel can be combined for quantity pricing.

CRL DRY GLAZE U-CHANNEL WITH VINYL

- Individually packaged 2.49m lengths
- Clear vinyl secures glass in channel and eliminates the need for messy silicone
- Recess in bottom of channel hides caulk line

NOTE: Glass is not included

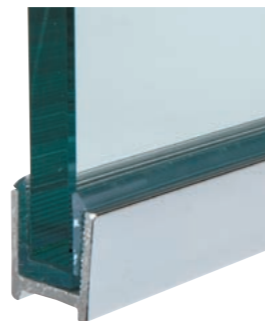

FROM ONLY **£10.40***

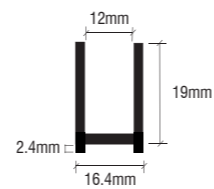

For 10mm glass



STEP 1
Fix flexible vinyl for interior of shower



STEP 2
Insert glass panel into channel



STEP 3
Fit rigid leg vinyl into channel to secure glass



STEP 4
Done!

SALE PRICE EACH (INC. 10% DISCOUNT)

CAT. NO.	FINISH	GLASS SIZE	1	10	50
DUC516BA	Brite Anodised	8mm	£14.00	£12.60	£11.35
DUC516BN	Brushed Nickel	8mm	£15.35	£13.95	£12.80
DUC38BA	Brite Anodised	10mm	£12.85	£11.50	£10.40
DUC38BN	Brushed Nickel	10mm	£14.35	£13.00	£11.95

*Price based on order quantity of 50 (CAT. NO. DUC38BA). Minimum order: 1 each. All u-channel can be combined for quantity pricing.

SHOWER HINGES

NEW VERSION

CRL RIVIERA SERIES

FROM ONLY **£20.35***



CAT. NO. R1V180RNCH

Easy to clean

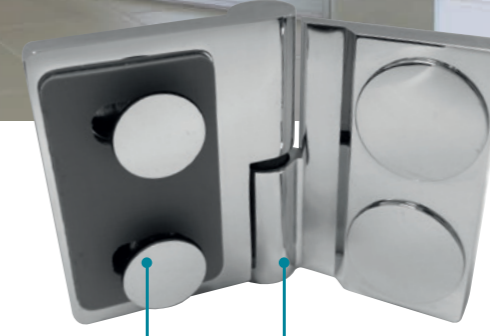

CAT. NO. R1V044LCH

Mounting screws concealed

Hinges lift door when opening to avoid bottom sweep dragging



CAT. NO. R1V90CH
Polished Chrome fixed panel clamp

FROM ONLY **£16.65^A**

Being a gravity type hinge, the weight of the door assists with the self-closing feature. The attractive flush mount fastener is on the rear of the hinge allows easy cleaning. Mounting screws are concealed. Made of solid brass. Available in polished chrome.

SALE PRICE EACH (INC. 10% DISCOUNT)

CAT. NO.	DESCRIPTION	HANDING	1	16
R1V180LNCH	Polished Chrome glass-to-glass mount hinge	Left	£23.65	£21.50
R1V180RNCH	Polished Chrome glass-to-glass mount hinge	Right	£23.65	£21.50
R1V044LCH	Polished Chrome offset wall mount hinge	Left	£22.35	£20.35
R1V044RCH	Polished Chrome offset wall mount hinge	Right	£22.35	£20.35

*Price based on order quantity of 16 (CAT. NO. R1V044LCH). Minimum order: 1 each. All shower hinges can be combined for quantity pricing.

^APrice based on order quantity of 50 (CAT. NO. R1V90CH). Minimum order: 1 each.



MAXIMUM CAPACITIES	8MM GLASS		10MM GLASS	
	WEIGHT	DOOR WIDTH	WEIGHT	DOOR WIDTH
Using Two Hinges	41kg	914mm	41kg	762mm

NOTE: Do not exceed maximum door weight or width when choosing proper quantity of hinges.



CRL VIENNA SERIES



- 10 to 12mm glass
- Available as 0° or 5° factory set closing positions
- Use the 5° pre-set model for tighter closure into shower interior
- Opens up to 90° in and 90° out
- Self-centering when within 15° of closed position



SALE PRICE EACH (INC. 10% DISCOUNT)

STANDARD SET CAT.NO.	5° PRE-SET CAT.NO.	DESCRIPTION	1	16
V1E037CH	V1E537CH	Wall mount full back plate	£26.45	£24.05
V1E180CH	V1E580CH	180° glass-to-glass	£35.75	£32.45

Minimum order: 1 each. All shower hinges can be combined for quantity pricing.

CRL ADJUSTABLE VIENNA SERIES



- 10 to 12mm glass
- Adjustable to any angle up to 90° without having to take door down
- Opens up to 90° in and 90° out (at factory set position)
- Self-centering when within 15° of closed position



SALE PRICE EACH (INC. 10% DISCOUNT)

CAT. NO.	DESCRIPTION	1	16
V1E337CH	Adjustable wall mount full back plate	£30.50	£27.80
V1E380CH	Adjustable 180° glass-to-glass	£41.95	£38.15

Minimum order: 1 each. All shower hinges can be combined for quantity pricing.

CRL GENEVA SERIES



- 8 to 12mm glass
- Available as 0° or 5° factory set closing positions
- Use the 5° pre-set model for tighter closure into shower interior
- Opens up to 90° in and 90° out
- Self-centering when within 15° of closed position

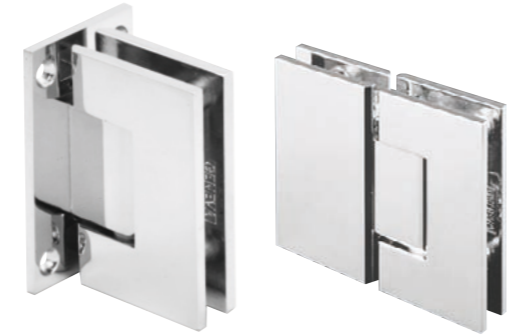

SALE PRICE EACH (INC. 10% DISCOUNT)

STANDARD SET CAT.NO.	5° PRE-SET CAT.NO.	DESCRIPTION	1	16
GEN037CH	GEN537CH	Wall mount full back plate	£18.20	£16.65
GEN180CH	GEN580CH	180° glass-to-glass	£24.65	£22.40

Minimum order: 1 each. All shower hinges can be combined for quantity pricing.

CRL ADJUSTABLE GENEVA SERIES



- 8 to 12mm glass
- Adjustable to any angle up to 90° without having to take door down
- Opens up to 90° in and 90° out (at factory set position)
- Self-centering when within 15° of closed position



SALE PRICE EACH (INC. 10% DISCOUNT)

CAT. NO.	DESCRIPTION	1	16
GEN337CH	Adjustable wall mount full back plate	£21.20	£19.25
GEN380CH	Adjustable 180° glass-to-glass	£31.95	£29.05

Minimum order: 1 each. All shower hinges can be combined for quantity pricing.

CRL PINNACLE SERIES



- 8 to 12mm glass
- Available as 0° or 5° factory set closing positions
- Use the 5° pre-set model for tighter closure into shower interior



SALE PRICE EACH (INC. 10% DISCOUNT)

STANDARD SET CAT.NO.	5° PRE-SET CAT.NO.	DESCRIPTION	1	16
P1N037CH	P1N537CH	Wall mount full back plate	£20.10	£18.25
P1N180CH	-	180° glass-to-glass	£28.10	£25.60
-	P1N580CH	180° glass-to-glass	£43.25	£39.35

Minimum order: 1 each. All shower hinges can be combined for quantity pricing.

CRL ADJUSTABLE PINNACLE SERIES



- 8 to 12mm glass
- Adjustable to any angle up to 90° without having to take door down
- Opens up to 90° in and 90° out (at factory set position)
- Self-centering when within 15° of closed position



SALE PRICE EACH (INC. 10% DISCOUNT)

CAT. NO.	DESCRIPTION	1	16
P1N337CH	Adjustable wall mount full back plate	£22.95	£20.90
P1N380CH	Adjustable 180° glass-to-glass	£36.45	£33.15

Minimum order: 1 each. All shower hinges can be combined for quantity pricing.

DOOR HARDWARE

AVAILABLE FROM STOCK FOR SAME-DAY DISPATCH

CRL STANDARD LENGTH DOOR RAILS

- For 10mm or 12mm 'all glass doors'
- Adjust and align doors without removal
- With or without locks
- 908mm lengths

FROM ONLY
£138.75*



CAT. NO.	GLASS	FINISH	LOCK	PRICE EACH	
				1	8
EDR4SBS12	12mm	Brushed	Without	£145.85	£138.75
EDR4SBS12L	12mm	Brushed	With	£170.35	£162.15
EDR4SPS12	12mm	Polished	Without	£145.85	£138.75
EDR4SPS12L	12mm	Polished	With	£170.35	£162.15
EDR4SBS38	10mm	Brushed	Without	£145.85	£138.75
EDR4SBS38L	10mm	Brushed	With	£170.35	£162.15
EDR4SPS38	10mm	Polished	Without	£145.85	£138.75
EDR4SPS38L	10mm	Polished	With	£170.35	£162.15

*Price based on order quantity of 8 (CAT. NO. EDR4SBS12). Minimum order: 1 each. Door rails can be combined for quantity pricing.



Custom finishes are also available. Call for details.

CRL 'T' STYLE DOOR PULL HANDLE

- To suit glass thickness 8 to 15mm
- Grade 304 Stainless Steel
- Sold per pair

FROM ONLY
£26.95*



CAT. NO.	FINISH	LENGTH	DIAMETER	PRICE PER PAIR	
				1	5
600LPBSEU	Brushed Stainless Steel	600mm	32mm	£35.50	£26.95

*Price based on order quantity of 5. Minimum order: 1 each.



CRL TOP DOOR PATCH FITTING WITH INSERT

- 65mm pivot setback
- High density cast body
- For 10 or 12mm glass
- Top Pivots sold separately

FROM ONLY
£18.85*



CAT. NO.	FINISH	PRICE EACH	
		1	6
PH21ABS	Brushed Stainless Steel	£20.95	£18.85

*Price based on order quantity of 6. Minimum order: 1 each.



YOU MAY ALSO NEED...



CRL VARIABLE POWER FLOOR SPRING

FROM ONLY
£85.00*

- The perfect door closer to support CRL's patch hardware
- Interchangeable spindle heights
- Warranty information and cross reference chart available
- 120kg capacity, 1067mm wide doors
- Narrow 82mm width cement box
- EN3 medium strength floor spring
- Complete with cement box, brushed stainless cover plate and standard height spindle (other heights ordered separately)

CAT. NO.	DESCRIPTION	PRICE EACH			
		1	6	48	96
EUCRL8460V	Variable power floor spring	£100.00	£95.00	£89.00	£85.00

*Price based on order quantity of 96. Minimum order: 1 each.

Install glass balustrades with ease...

**Simple.
 Fast.
 Unique.**

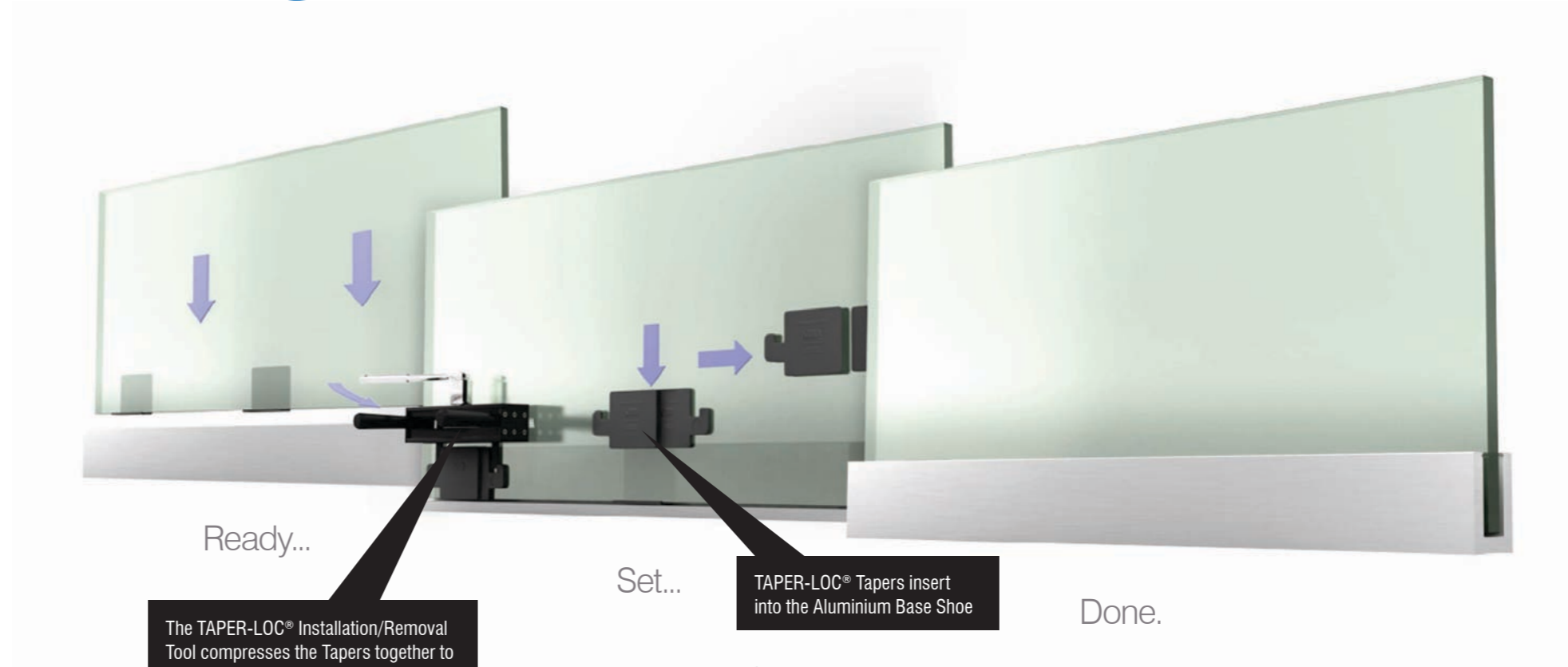

Ready...
 The TAPER-LOC[®] Installation/Removal Tool compresses the Tapers together to lock the glass in place

Set...
 TAPER-LOC[®] Tapers insert into the Aluminium Base Shoe

Done.



TL5X10
 CRL TAPER-LOC[®] Taper Set for Monolithic Toughened Glass

The System includes an Installation/Removal Tool and CRL TAPER-LOC[®] Tapers for 12mm, 15mm, and 19mm toughened monolithic glass applications, and 13.52mm, 17.52mm, 21.52mm, and 25.52mm laminated toughened glass applications. Unique because they use a horizontal taper lock design, TAPER-LOC[®] Tapers are simply installed with CRL's exclusive TLK12 Installation/Removal Tool.

U.S. Patent Numbers 8,122,654 & 8,201,366 and Commonwealth of Australia Patent No. 2008207524

- Reduces Installation Time by 50%, with no need for wet cement
- For use with Monolithic and Laminated Toughened Glass
- Easy installation with one compact Installation/Removal Tool
- Designed by CRL for Commercial and Residential Applications

For a demonstration visit taper-loc.co.uk



CRL Glass Awning Systems

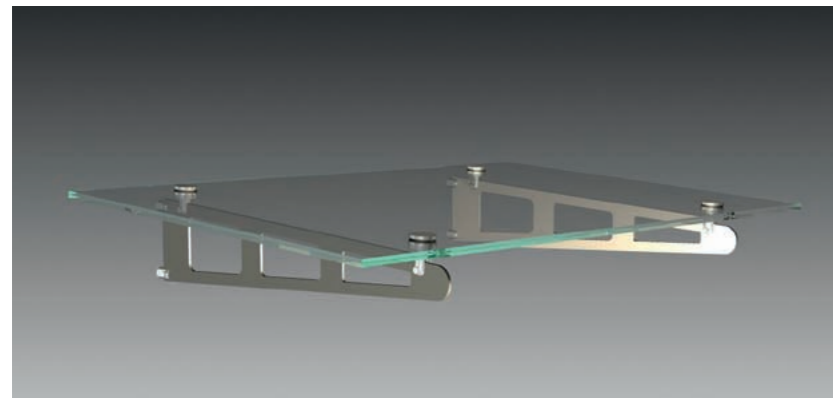

CRL Awning Brackets for 1100mm Projection Glass Canopy

- Sold as a set
- 304 Grade Stainless Steel
- Brushed Stainless Steel finish
- Corrosion Protecting Class 2 – DIN EN 10088
- Glass thickness range 13.52mm to 17.52mm

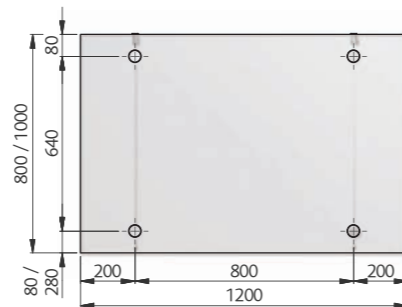
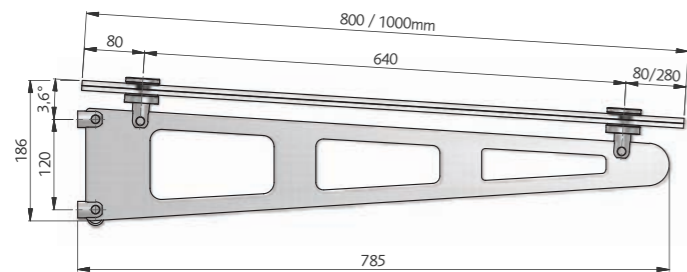

Sets consist of:

- Two struts
- Four point fittings with yoke
Ø 60mm without glass

**FROM ONLY
£297.00***

CAT. NO.	OVERHANG	BLADE	OVERHANG	GLASS	CANOPY SLOPE
EUGAB1000BS	Ø 60mm	800mm	800mm to 1000mm	laminated safety glass consisting of heat strengthened glass with quadruple foil 6/1.52/6mm or 8/1.52/8mm	max. 3.6°

CAT. NO.	DESCRIPTION	PRICE EACH	
		1	5
EUGAB1000BS	Awning brackets for 1100mm projection glass canopy	£319.50	£297.00
EUGASWRENCH45	Hook wrench for point fittings Ø 45 - 60 mm	£31.20	£28.60
EUGASWRENCH80	Hook wrench for point fittings Ø 80 mm	£34.05	£31.25

*Price based on order quantity of 5 each (CAT. NO. EUGAB1000BS). Minimum order: 1 each.

YOU MAY ALSO NEED...



Hook wrench for point fittings



Structural Standoffs

CRL HEAVY-DUTY STANDOFFS

- Complete with mounting plate
- For use with 12 and 19mm monolithic toughened glass or 13.52 and 21.52mm laminated toughened glass
- Brushed or polished 316 grade stainless finishes
- Designed for steel, wood, and concrete substrates
- Full engineering data available at crlaurence.co.uk



These heavy-duty Rail Standoffs are designed for glass handrail or guardrail applications. Standoff Fittings have a 44mm standard projection from the installed attachment point. Custom lengths and diameters are also available.



THE NEXT GENERATION IN SURFACE PROTECTION
SEE PAGE 06

CRL GLASS RAIL STANDOFFS

- For use with 12 and 19mm monolithic toughened glass or 13.52 and 21.52mm laminated toughened glass
- Brushed or polished 316 grade stainless finishes
- Designed for steel, wood, and concrete substrates
- Structural Test Data Available
- Full engineering data available at crlaurence.co.uk



CRL's heavy-duty, point supported Glass Rail Standoff Fittings gives the installer more adjustment during installation for those tricky job site mounting conditions. The steel back plate can be fastened directly to steel, concrete, or wood substrates and shimmed as required with blocking.



THE NEXT GENERATION IN SURFACE PROTECTION
SEE PAGE 06

CRL GLASS RAIL STANDOFF FITTINGS WITH MOUNTING PLATE

- 51mm standard caps
- Two 19mm diameter holes per fitting



FROM ONLY £95.95*

SALE PRICE EACH (INC. 15% DISCOUNT)

CAT. NO.	FINISH	1	20
RS0B20BS	Brushed stainless	£105.45	£95.95
RS0B20PS	Polished stainless	£106.00	£96.60

*Price based on order quantity of 20 each (CAT. NO. RS0B20BS). Minimum order: 1 each.

CRL GLASS RAIL STANDOFF FITTINGS WITH MOUNTING PLATE

- 60mm domed caps
- Ready to install
- Low maintenance with special coating to prevent corrosion
- Two 19mm diameter holes per fitting



FROM ONLY £90.30*

SALE PRICE EACH (INC. 15% DISCOUNT)

CAT. NO.	FINISH	1	20
RS0B25BS	Brushed stainless	£99.35	£90.30
RS0B25PS	Polished stainless	£99.75	£90.65

*Price based on order quantity of 20 each (CAT. NO. RS0B25BS). Minimum order: 1 each.

CRL GLASS RAIL STANDOFF BASE WITH STANDARD CAP

- 51mm standard caps
- One 19mm diameter hole per fitting



FROM ONLY £39.55*

SALE PRICE EACH (INC. 15% DISCOUNT)

CAT. NO.	FINISH	1	20
RS0B2134BS	Brushed stainless	£44.60	£39.55
RS0B2134PS	Polished stainless	£47.65	£42.25

*Price based on order quantity of 20 each (CAT. NO. RS0B2134BS). Minimum order: 1 each.

CRL GLASS RAIL POINT SUPPORTED STANDOFF BASE WITH DOMED CAP

- 60mm domed caps
- One 19mm diameter hole per fitting



FROM ONLY £30.10*

SALE PRICE EACH (INC. 15% DISCOUNT)

CAT. NO.	FINISH	1	20
RS0B2135BS	Brushed stainless	£33.95	£30.10
RS0B2135PS	Polished stainless	£36.35	£32.15

*Price based on order quantity of 20 each (CAT. NO. RS0B2135BS). Minimum order: 1 each.



European HQ

Manchester

Charles Babbage Avenue, Kingsway Business Park, Rochdale, OL16 4NW, England



Germany

Stuttgart

Boschstrasse 7
D-74360 Ilsfeld, Germany



Denmark

Copenhagen

Stamholmen 70 Unit B,
DK-2650 Hvidovre, Denmark

The Complete Collection

- EUAB12UK for the Binder with the following selection of brochures:
 - EUTL14 TAPER-LOC® Frameless Glass Balustrade System
 - DH12UK Door Hardware & Partitioning Systems for Glass
 - RS12UK Aluminium Railing & Windscreen Systems
 - GA13UK Glass Awnings Brochure
 - SDH12UK Shower Door Hardware
 - SDS12UK Sliding Door Systems for Glass
- EUAB12 for the Binder only

The ring binder enables you to add new brochures as they are published.



For your copy call: **00 800 0421 6144** or email: **CRL@crlaurence.co.uk**

For more information Freephone 00 800 0421 6144 (UK & Europe) | Freefax 00 800 0262 3299

