

glass

PRODUCT SHOWCASE

New and popular products at discount prices
Tools and supplies for the glass shop

SPRING '16



FROM ONLY
£1.69
PER CARTRIDGE

For more details see **page 4**

NOW AVAILABLE IN 7 COLOURS!



CRL PROFESSIONAL SEALANT

Neutral cure • Low modulus
Pure silicone formula

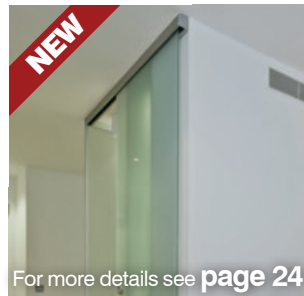

COMPACT-X SLIDING DOOR SYSTEM

CRL COMPACT-X is our all new compact sliding solution for frameless glass panels

For more details see **page 24**

ENHANCED DOUBLE SOFT CLOSE SYSTEM

Glass and Glazing Supplies

Shower Hardware

Installation Tools

Railing Hardware



ORDER TODAY FROM THE GLOBAL MARKET LEADER

CALL FREE FROM THE UK AND IRELAND ON 00 800 0421 6144

VIEW ALL PRODUCT RANGES ONLINE

crlaurence.co.uk

Glass Handling Tools



CRL WOOD'S POWR-GRIP® ABS HANDLE VACUUM CUP

- 203mm diameter pad
- Lightweight, heavy-duty ABS handle
- Check valve allows re-pumping without loss of remaining vacuum
- Release valve lever permits quick and complete release
- Fast attachment on smooth, non-porous flat surfaces
- Red-line indicator warns user of any vacuum loss
- Supplied with protective carrying case

FROM ONLY
£26.00*

Wood's
Powr-Grip CE



CAT. NO.	DESCRIPTION	1	4	10
N4000	ABS Handle Vacuum Cup	£29.50	£27.50	£26.00

*Minimum order: 1 each. Price based on an order quantity of 10 each.

CRL PUMP-ACTION VACUUM LIFTER FOR CURVED GLASS

- 203mm diameter pad
- Designed primarily for lifting curved architectural glass
- Excellent also for thin, flexible materials
- Red-line indicator warns user of any vacuum loss
- Moulded carrying case
- 56kg lifting capacity

FROM ONLY
£31.60*

CE



CAT. NO.	DESCRIPTION	1	4	10
S109	Pump-Action Vacuum Lifter	£35.70	£33.65	£31.60

*Minimum order: 1 each. Price based on an order quantity of 10 each.

CRL WOOD'S POWR-GRIP® METAL HANDLE VACUUM CUP

- 203mm diameter pad
- Durable metal handle
- Check valve allows re-pumping without loss of remaining vacuum
- Fast attachment on smooth, non-porous flat surfaces
- Red-line indicator warns user of any vacuum loss
- Release valve lever permits quick, complete release

FROM ONLY
£57.25*

Wood's
Powr-Grip CE



CAT. NO.	DESCRIPTION	1	4	10
N4950	Metal Handle Vacuum Cup	£62.30	£59.80	£57.25

*Minimum order: 1 each. Price based on an order quantity of 10 each.

CRL ALUMINIUM FRAME VACUUM LIFTERS

- Sturdily built traditional design aluminium frame
- Each suction pad operates separately
- 114mm diameter suction pads

SAVE 10%



FROM ONLY
£23.40*

CAT. NO.	DESCRIPTION	LIFTING CAPACITY	1	6
05061	1 Vacuum Pad	30kg	£26.30	£23.40
05062	2 Vacuum Pads	60kg	£29.95	£26.50
05063	3 Vacuum Pads	100kg	£36.00	£30.55

*Minimum order: 1 each. Price based on an order quantity of 6 each (CAT. NO. 05061). Price includes 10% discount. Special discount available from 1st February to 30th April 2016.

CRL S338 SURE-GRIP 203MM VACUUM LIFTER

- Greatest lifting capacity of any 203mm pump activated vacuum lifter
- One hand pump and attachment for safety when needed
- Superior "press-and-pump" attachment feature
- Built-in vacuum loss indicator
- Soft contoured sure-grip handle for comfort
- Sturdy moulded carrying case



CAT. NO.	DESCRIPTION	1	4	10
S338	Sure-Grip Vacuum Lifter	£29.95	£29.05	£28.05

*Minimum order: 1 each. Price based on an order quantity of 10 each.

FROM ONLY
£28.05*

112KG LIFTING CAPACITY
Safety factor 2:1



CONVENIENT VACUUM INDICATOR



SUPERIOR COMFORT AND GRIP



FAST RELEASE



Silicones and Accessories

CRL CRYSTAL CLEAR SILICONE

- High clarity when cured
- Applications include shower enclosures and speciality glass assemblies
- 310ml cartridge
- 12 per case
- Special countertop display box

SAVE 10%

FROM ONLY **£1.82***



CAT. NO.	COLOUR	1	12	120	240
EUCCS	Crystal Clear	£2.09	£1.92	£1.87	£1.82

*Minimum order: 1 each. Price based on an order quantity of 240 each. Price includes 10% discount. Special discount available from 1st February to 30th April 2016.

CRL CLEAR SHOWER SEALANT

- Acetic cure formula
- Plastic cartridges with screw-on nozzles
- High modulus
- 300ml cartridge
- 12 per case
- Special countertop display box

SAVE 10%

FROM ONLY **£1.29***



CAT. NO.	COLOUR	1	12	120	240
EU33SC	Clear	£1.59	£1.39	£1.34	£1.29

*Minimum order: 1 each. Price based on an order quantity of 240 each. Price includes 10% discount. Special discount available from 1st February to 30th April 2016.

CRL NEUTRAL CURE LOW MODULUS SILICONE

- Low odour, neutral cure formula
- Compatible with insulating glass glazing
- Excellent adhesion to most surfaces
- Low modulus
- 300ml cartridge
- 12 per case
- Special countertop display box
- Conforms to ISO 11600
- High grade formula - low shrinkage

CONSTRUCTION SEALANT

BEST SELLER

FROM ONLY **£1.69***

THE PROFESSIONALS' CHOICE



NOW AVAILABLE IN 7 COLOURS



CAT. NO.	COLOUR	1	12	120	240
EURTV408C	Clear	£1.99	£1.79	£1.74	£1.69
EURTV408W	White	£1.99	£1.79	£1.74	£1.69
EURTV408BL	Black	£1.99	£1.79	£1.74	£1.69
EURTV408G	Grey	£1.99	£1.79	£1.74	£1.69
EURTV408BR	Brown	£1.99	£1.79	£1.74	£1.69
EURTV408A	Anthracite NEW!	£1.99	£1.79	£1.74	£1.69
EURTV408R	Rosewood NEW!	£1.99	£1.79	£1.74	£1.69

*Minimum order: 1 each. Price based on an order quantity of 240 each (CAT. NO. EURTV408C).

CRL COATED GLASS SEALANTS

- High quality, professional and universal paintable sealant
- Used for the sealing of connecting joints and glazing systems
- Conforms with Pilkington Activ and Saint Gobain Bio Clean
- Resistant to weather, UV, water, and fungus
- 290 ml cartridge
- 12 per case

SAVE 10%

THE PROFESSIONALS' CHOICE

FROM ONLY **£3.65***

CAT. NO.	COLOUR	1	12	120	240
EUCGSBL	Black	£4.15	£3.85	£3.75	£3.65
EUCGSBR	Brown	£4.15	£3.85	£3.75	£3.65
EUCGSG	Grey	£4.15	£3.85	£3.75	£3.65
EUCGSW	White	£4.15	£3.85	£3.75	£3.65

*Minimum order: 1 each. Price based on an order quantity of 240 each (CAT. NO. EUCGSBL). Price includes 10% discount. Special discount available from 1st February to 30th April 2016.

CRL STANDARD SMOOTH ROD CAULKING GUN

- Our best seller is also a great value
- Thumb pressure release button
- Perfect for low viscosity materials

SAVE 10%

FROM ONLY **£2.05***

MORE OPTIONS AVAILABLE ONLINE

CAT. NO.	DESCRIPTION	1	12
ER3	Standard Smooth Rod Caulking Gun	£2.29	£2.05

*Minimum order: 1 each. Price based on an order quantity of 12 each. Price includes 10% discount. Special discount available from 1st February to 30th April 2016.

CRL E.Z.D. GLAZER DE-GLAZING TOOL

- Aids in the de-glazing of glass installed with silicone, foam tapes, butyl tapes, and other flexible materials
- Blade lays flat on the glass and slides into the glazing pocket
- Extremely simple to use

SAVE 10%

FROM ONLY **£33.95***

CAT. NO.	DESCRIPTION	1	6
EZ1010	E.Z.D. Glazer De-Glazing Tool	£36.65	£33.95
EZ1022	Replacement Blade	£16.50	-

*Minimum order: 1 each. Price based on an order quantity of 6 each (CAT. NO. EZ1010). Price includes 10% discount. Special discount available from 1st February to 30th April 2016.

CRL SEALANT FINISHING TOOL

- Lightweight and flexible, simplifies tooling of sealants
- Titanium catalyst material will not stick to silicone or other sealants
- 83mm x 89mm x 5mm

SAVE 10%

FROM ONLY **£1.89***



CAT. NO.	DESCRIPTION	1	6
55BSS	Sealant finishing tool	£2.49	£1.89

*Minimum order: 1 each. Price based on an order quantity of 6 each. Price includes 10% discount. Special discount available from 1st February to 30th April 2016.

CRL 12:1 RATIO STRAP FRAME CAULKING GUN

- Holds standard caulking cartridges
- Best choice for low to medium viscosity materials
- Instant pressure release to prevent run-on

SAVE 10%

FROM ONLY **£10.95***

MORE OPTIONS AVAILABLE ONLINE

CAT. NO.	DESCRIPTION	1	12
GA1203	12:1 Ratio Strap Frame Caulking Gun	£11.85	£10.95

*Minimum order: 1 each. Price based on an order quantity of 12 each. Price includes 10% discount. Special discount available from 1st February to 30th April 2016.

CRL 8-IN-1 PAINTER'S TOOL

- Multi purpose tool
- Comfort grip handle
- Overall length: 232mm
- Blade width: 76mm

SAVE 10%

FROM ONLY **£3.10***

CAT. NO.	DESCRIPTION	1	6
HW048	8-in-1 Painter's Tool	£4.20	£3.10

*Minimum order: 1 each. Price based on an order quantity of 6 each. Price includes 10% discount. Special discount available from 1st February to 30th April 2016.

CRL E.P.D.M. RUBBER SEALING STRIPS

with self-adhesive, fibreglass-armed tape

- Enables quick, easy and clean installation of double glazing
- Ensures water and airtightness between the frame and the insulating glass and between the insulating glass and the rubber
- Long-lasting
- Resistant to solvents
- Free of harmful substances

Great Value

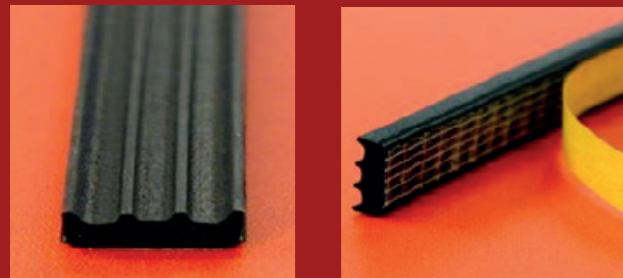

Quick, simple and clean mounting

FROM ONLY £22.50*

CAT. NO.	DESCRIPTION	SIZE	ROLL LENGTH	1	6	12
DGS309E	Black Rubber Sealing Strip	3 x 9mm	150m	£25.20	£23.80	£22.50
DGS312E	Black Rubber Sealing Strip	3 x 12mm	150m	£35.00	£33.00	£31.25
DGS408E	Black Rubber Sealing Strip	4 x 8mm	150m	£28.95	£27.30	£25.85
DGS410E	Black Rubber Sealing Strip	4 x 10mm	125m	£26.15	£24.70	£23.35
DGS415E	Black Rubber Sealing Strip	4 x 15mm	75m	£37.75	£35.60	£33.70
DGS510E	Black Rubber Sealing Strip	5 x 10mm	100m	£26.15	£24.65	£23.35

*Minimum order: 1 roll. Price based on an order quantity of 12 rolls. Sizes can be combined for quantity pricing.

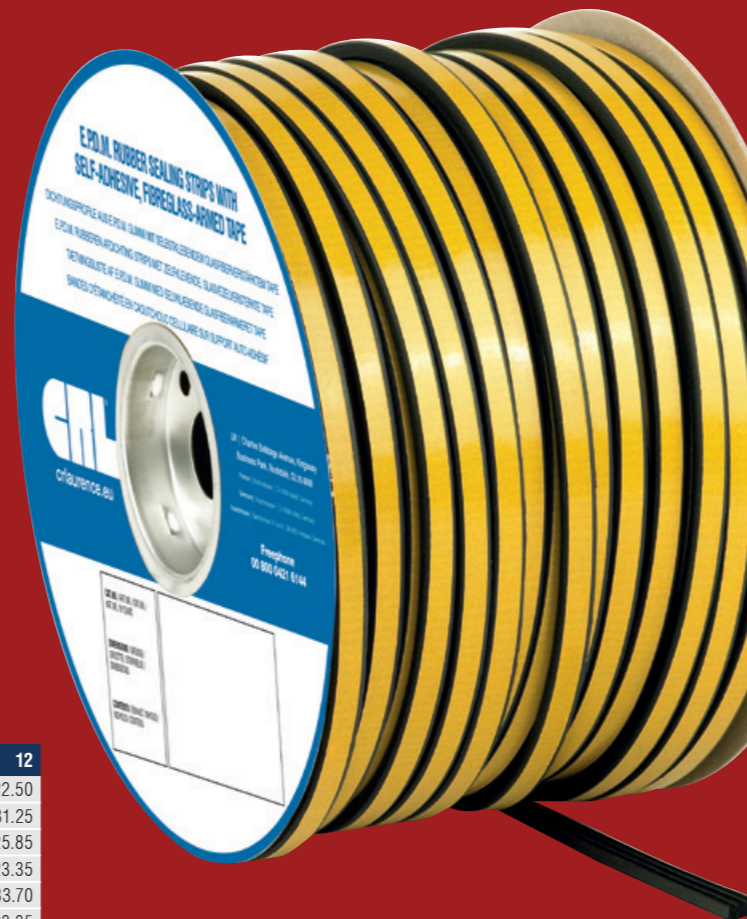

Mirror Products

CRL eg310 evergrip™ MIRROR ADHESIVE

Best seller

- Extra fast grab mirror adhesive
- Extra strong holding capacity
- Fast curing, with skin formation in about five minutes
- Adhesion to almost all surfaces
- Low VOC, solvent free, low odour
- 310ml cartridge

SAVE 10%

FROM ONLY £1.80*



CAT. NO.	DESCRIPTION	12	60	120	240
EG310	Mirror Adhesive	£2.15	£2.00	£1.90	£1.80

*Minimum order: 12 each. Price based on an order quantity of 240 each. Price includes 10% discount. Special discount available from 1st February to 30th April 2016.

CRL ALUMINIUM TAPE WITH LINER

- Premium quality
- Protects the back of the mirror against moisture ingress
- 600mm x 45m

SAVE 10%

FROM ONLY £36.15*
PER ROLL



CAT. NO.	DESCRIPTION	1	10	25
2108600A	Aluminium Tape with Liner	£59.15	£45.45	£36.15

*Minimum order: 1 roll. Price based on an order quantity of 25 rolls. Price includes 10% discount. Special discount available from 1st February to 30th April 2016.

CRL MIRABAC POLYPROPYLENE MIRROR BACKING

SAVE 10%

- Keeps glass fragments together should mirror accidentally break thus reducing the chance of personal injury
- Ready to use and easy-to-apply
- Tested to BS EN 12600
- 60 Micron

FROM ONLY £8.10*
PER ROLL



CAT. NO.	LENGTH	WIDTH	1	10	20
21051A	200mm	100m	£15.70	£12.00	£8.10
21051	300mm	100m	£23.50	£17.90	£12.20
21052	450mm	100m	£34.90	£26.60	£18.00
21053	604mm	100m	£47.20	£35.95	£24.35
21056A	770mm	250m	£147.15	£112.10	£75.95
21058B	650mm	250m	£126.65	£96.50	£65.40
21058A	914mm	250m	£175.55	£133.80	£90.65
21060A	1220mm	250m	£237.65	£181.00	£122.65

*Minimum order: 1 roll. Price based on an order quantity of 20 rolls (CAT. NO. 21051A). Price includes 10% discount. Special discount available from 1st February to 30th April 2016.

CRL ALL-PURPOSE FOAM MOUNTING TAPE

FROM ONLY £2.85*
PER ROLL

- Highly adhesive and flexible
- Conforms to a wide variety of surfaces
- Just peel and apply
- Excellent for mirrors, glass, metals, plastics and other surfaces
- Ideal for use in combination with mirror adhesive

CAT. NO.	LENGTH	WIDTH	THICKNESS	ROLLS / CASE	1	16	23	80	115
CRL211612	33m	12.5m	1.6mm	23	£5.00	-	£4.45	-	£4.25
CRL211634	33m	19m	1.6mm	16	£6.35	£5.70	-	£5.45	-
CRL210812	15m	12.5m	3mm	23	£3.30	-	£2.95	-	£2.85
CRL210834	15m	19m	3mm	16	£4.55	£4.10	-	£3.95	-

*Minimum order: 1 roll. Price based on an order quantity of 5 cases (CAT. NO. CRL210812). Price includes 10% discount. Special discount available from 1st February to 30th April 2016.



SAVE 10%





Glaziers' Tools

CRL FACE CAP REMOVER

- Specially designed for the removal of exterior face caps on a wide variety of curtain walls
- Removes most pressure bar system face caps
- Adjustable for varying size face caps
- Lightweight, easy to grip handle



Tailor made for curtain wall installers!



FROM ONLY **£22.19***

CAT. NO.	DESCRIPTION	1	5	10
FCR1	Face Cap Remover	£31.39	£28.29	£22.19

*Minimum order: 1 each. Price based on an order quantity of 10 each.

CRL PLATE GLASS LIFTING TOOL

- For lifting and setting plate glass
- Helps prevent lifting related injuries
- Aids in storefront window installation
- Width: 273mm

SAVE 10%

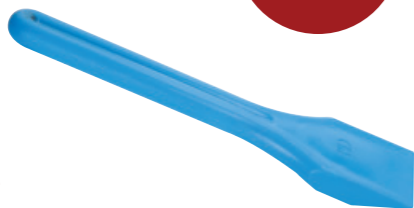

ONLY **£5.00***

CAT. NO.	DESCRIPTION	1
PGL11	Plate Glass Lifting Tool	£5.00

*Minimum order: 1 each. Price based on an order quantity of 1 each. Price includes 10% discount. Special discount available from 1st February to 30th April 2016.

CRL LIGHTWEIGHT GLAZIER'S HAMMER

- Ideal for glazing and picture framing
- 295mm lacquered ashwood handle
- Forged steel hardened and fully polished head with stabilizing supports
- Overall Length: 310mm

SAVE 10%



FROM ONLY **£14.75***

CAT. NO.	DESCRIPTION	1	5
0220	Glazier's Hammer	£15.85	£14.75

*Minimum order: 1 each. Price based on an order quantity of 5 each. Price includes 10% discount. Special discount available from 1st February to 30th April 2016.

CRL BLOCK LEVERS

- Handy tool for all glazing jobs
- Choose either the all wood or the strong wooden handle with hard-wearing plastic head block lever

SAVE 10%



FROM ONLY **£1.20***

CAT. NO.	DESCRIPTION	1	10
0735	Plastic Head Block Lever	£2.95	£2.55
0736	All Wood Block Lever	£1.35	£1.20

*Minimum order: 1 each. Price based on an order quantity of 10 each (CAT. NO. 0736). Price includes 10% discount. Special discount available from 1st February to 30th April 2016.

CRL CLEANER & DEGREASER

- Cleans surfaces for UV adhesives
- Removes all traces of grease and oils and leaves no residue
- Evaporates quickly
- Contains no ozone depleting chemicals
- Big 660ml cans

No residue formula



FROM ONLY **£6.05*** PER CAN

CAT. NO.	CONTENTS	1	12	36
EUCRL7528	660ml	£7.55	£6.70	£6.05

*Minimum order: 1 can. Price based on order quantity of 36 cans.

CRL GLASS AND MIRROR CLEANER

Private label available

- A long time favourite of the glass industry
- Ammoniated formula with a pleasant aroma
- Twelve big 660ml cans per case



FROM ONLY **£1.70*** PER CAN

SAVE 10%

CAT. NO.	CONTENTS	12	60	144
EB1701	660ml can	£2.15	£1.90	£1.70

*Minimum order: 12 cans. Price based on an order quantity of 144 cans. Price includes 10% discount. Special discount available from 1st February to 30th April 2016.

CRL STAINLESS STEEL CLEANER

- Registered INS H1 food safe
- Cleans, polishes, and protects
- Resists fingerprints, grease, and water spatter
- Preserves the factory finish of stainless steel



FROM ONLY **£4.60*** PER CAN

SAVE 10%

CAT. NO.	CONTENTS	1	12	36
CRLSSC600	600ml can	£5.95	£5.25	£4.60

*Minimum order: 1 can. Price based on an order quantity of 36 cans. Price includes 10% discount. Special discount available from 1st February to 30th April 2016.

CRL CUT-RESISTANT LEVEL 5 WRIST GUARDS

BSEN388 rated

- Our best value wrist guard
- Ambidextrous - can be worn on either arm
- Velcro fastening
- Durable and comfortable
- BS EN 388 X-5-X-3
- Sold by the pair

SAVE 10%



FROM ONLY **£10.19*** PER PAIR

CAT. NO.	LENGTH	1	12	24
0601	152 mm	£12.39	£10.79	£10.19
06012	203 mm	£13.79	£11.99	£11.39

*Minimum order: 1 pair. Price based on an order quantity of 24 pairs (CAT. NO. 0601). Price includes 10% discount. Special discount available from 1st February to 30th April 2016.

CRL CUT-RESISTANT KEVLAR® GLOVES

BSEN388 rated

- Cut Level 5
- Tested EN388 4544
- Sold by the pair
- Come in three sizes

SAVE 10%



FROM ONLY **£6.25*** PER PAIR

CAT. NO.	SIZE	1	20
0625A	Small	£7.75	£6.25
0626A	Medium	£7.75	£6.25
0627A	Large	£7.75	£6.25

*Minimum order: 1 pair. Price based on an order quantity of 20 pairs (CAT. NO. 0625A). Price includes 10% discount. Special discount available from 1st February to 30th April 2016.



Detectors



CRL GLASS-CHEK ELITE

- Identifies laminated glass in a window
- Measures the thickness of the laminate inner-layer
- Graphical display shows profile of window
- Can identify piece of glass with Low-e coating



SAVE
£50.00

FROM ONLY
£890.00*

CAT. NO.	DESCRIPTION	1	4
GC3200	Glass-Chek Elite	£935.00	£890.00

*Minimum order: 1 each. Price based on an order quantity of 4 each.
Price includes £50 discount. Special discount available from 1st February to 30th April 2016.

CRL METRIC SCALE GLASS THICKNESS LASER

- Measures from inside of the building - no glass removal is necessary
- Calculates thicknesses of insulating glass, laminated, bullet-resistant, and single lite float glass
- Padded carrying case and batteries included
- Provides metric measurements

SAVE
£25.00

ONLY
£206.50*



CAT. NO.	DESCRIPTION	1
MG1500MM	Metric Scale Glass Thickness Laser	£206.50

*Minimum order: 1 each. Price based on an order quantity of 1 each.
Price includes £25 discount. Special discount available from 1st February to 30th April 2016.

CRL CONDUCTIVE COATING DETECTOR

- Red indicator lights up on contact with Low-e
- Edge stop restricts use to edge of glass, prevents scratching
- Small enough to fit in your shirt pocket

SAVE
10%

ONLY
£21.75*



CAT. NO.	DESCRIPTION	1
CD1	Conductive Coating Detector	£21.75

*Minimum order: 1 each. Price based on an order quantity of 1 each.
Price includes 10% discount. Special discount available from 1st February to 30th April 2016.

CRL GLASS GAUGE PRO

- Measures single and double glazed units
- Easy read double-sided rule with 2mm graduations
- Designed to fit around UPVC windows and doors
- Reflection device shows the thickness of each individual pane
- Specially designed ball-tip for maximum accuracy
- Manufactured from engineering grade plastic

NEW!

FROM ONLY
£32.50*



CAT. NO.	DESCRIPTION	1	6
0471B	Glass Gauge Pro	£34.95	£32.50

*Minimum order: 1 each. Price based on an order of 6 each.

Glass Cutters

FOR A PRECISE FINISH AND GREAT SAVINGS!

CRL TOYO® SUPERCUTTERS



CRL TOYO® ORIGINAL SUPERCUTTER®

- Premium quality
- Brass or plastic straight end handles
- 140 degree hone angle carbide wheel

FROM ONLY
£10.95*



SAVE
20%

CAT. NO.	DESCRIPTION	1	6	12
TC17B	Brass Handle	£13.75	£13.10	£11.20
TC17P	Plastic Handle	£13.40	£12.75	£10.95
TC17H	Replacement Cutting Head - Wide	£8.95	£8.50	£7.30

*Minimum order: 1 each. Price based on an order quantity of 12 each (CAT. NO. TC17P).
Price includes 20% discount. Special discount available from 1st February to 30th April 2016.

CRL TOYO® STRAIGHT "DRY WHEEL" SUPERCUTTER®

- Black handle and wide straight head
- Moulded handle for positive grip
- 140 degree hone angle, long-lasting TOYO® carbide wheel

FROM ONLY
£7.60*

THE ORIGINAL AND BEST



For Cutting
4-6mm
Glass

CAT. NO.	DESCRIPTION	1	6	12
TC20	Brass Handle	£9.30	£8.90	£7.60
TC20H	Replacement Cutting Head - Wide	£8.05	£7.65	£6.55

*Minimum order: 1 each. Price based on an order quantity of 12 each (CAT. NO. TC20).
Price includes 20% discount. Special discount available from 1st February to 30th April 2016.



Cerium Oxide

CRL HEAVY-DUTY SCRATCH POLISHER

- Polishes all types of glass, from windshields to watch crystals
- Use it hand-held or bench mounted for added stability
- Powered by a heavy-duty, double-insulated motor
- Sure grip handles on each end of the tool assembly provide control
- Includes 150mm Felt Wheel (CAT. NO. 1322) and 1kg of Cerium Oxide (CAT. NO. 1222A)

SAVE 10%

ONLY £614.95*

CAT. NO.	DESCRIPTION	1
1520	230V Scratch Polisher	£614.95
1520A	110V Scratch Polisher	£614.95

*Minimum order: 1 each. Price based on an order quantity of 1 each (CAT. NO. 1520). Price includes 10% discount. Special discount available from 1st February to 30th April 2016.



CRL PREMIUM CERIUM OXIDE

- Premium cerium oxide for fast stock removal
- Exceptional suspension qualities
- Ideal for recirculating slurry systems
- Easily cleaned from glass and equipment
- Contains no zinc
- Pink colour
- 20kg tub



FROM ONLY £308.00*
PER 20KG TUB

BEST PRICE!

CAT. NO.	DESCRIPTION	1	4	10
1222	Cerium Oxide	£363.00	£330.00	£308.00

*Minimum order: 1 each. Price based on an order quantity of 10 each.

CRL FELT POLISHING WHEELS FOR BOVONE BEVELLER

- Spiral wound



FROM ONLY £19.60*

CAT. NO.	SIZE	1	10
1109FA	150 x 25 x 70mm	£23.65	£19.60
1109XA	150 x 25 x 70mm	£58.35	£50.00
1109MM	150 x 25 x 40mm	£32.65	£28.00
1109FB	185 x 25 x 115mm	£27.65	£23.70
1109XB	185 x 25 x 115mm	£64.30	£55.15

*Minimum order: 1 each. Price based on an order quantity of 10 each. (CAT. NO. 1109FA)

CRL BAUME GAUGE KIT

- Kit consists of a 390mm tall glass phial/jar, plus a glass hydrometer scale with 50 graduations
- For testing Cerium Oxide in suspension



FROM ONLY £28.55*

CAT. NO.	DESCRIPTION	1
1217	Complete Kit	£66.00
12172	Scale Hydrometer (No Jar)	£28.55
12174	Jar Only	£56.00

*Minimum order: 1 each. Price based on an order quantity of 1 each (CAT. NO. 1217).

CRL DELUXE SERENITY SERIES SLIDING SHOWER DOOR SYSTEM

- For use with 8 to 10mm monolithic toughened glass

CAT. NO. SER78BS BRUSHED STAINLESS DELUXE 180 DEGREE KIT
CAT. NO. SER78PS POLISHED STAINLESS DELUXE 180 DEGREE KIT

Deluxe 180 Degree Kit Includes:

- 1 - 2m length header support bar
- 4 - Rollers
- 1 - Stopper
- 2 - Track holder fittings for wall
- 2 - Track holder fittings for fixed panel
- 1 - Thru-glass pull
- 1 - Door guide
- 1 - 2.16m length clear L-jamb

FROM ONLY £185.60*



Image shown here:
CAT. NO. SER90BS

CAT. NO.	DESCRIPTION	FINISH	1	6
SER78BS	Deluxe 180 Degree Serenity Kit	Brushed Stainless	£206.00	£185.60
SER78PS	Deluxe 180 Degree Serenity Kit	Polished Stainless	£222.35	£201.95
SER90BS	90 Degree Accessory Kit	Brushed Stainless	£6.30	£5.70
SER90PS	90 Degree Accessory Kit	Polished Stainless	£6.60	£6.05
SERAHW2BS	Track Holder Fittings for Wall	Brushed Stainless	£17.65	£15.95
SERAHW2PS	Track Holder Fittings for Wall	Polished Stainless	£20.50	£18.45

*Price based on order quantity of 6 each (CAT. NO. SER78BS). Minimum order: 1 each. Finishes can be combined for quantity pricing. 90 degree accessory kit sold separately. Glass not included.

1 YEAR WARRANTY

CRL RECOMMENDS MONOLITHIC TOUGHENED GLASS

GLASS THICKNESS 8 to 10 mm



SEE THE COMPLETE RANGE

VISIT crlaurence.co.uk and view CAT. NO. SDH12UK



Shower Support Bars

CRL FRAMELESS SHOWER DOOR FIXED PANEL WALL-TO-GLASS SUPPORT BAR

FROM ONLY **£32.45***

- For 6mm to 8mm glass
- 19mm diameter tubular brass bar
- May be used as an alternative to CRL header kits to secure fixed panels and provide safety
- Provides fixed panel support for enclosures not going to ceiling
- Simply cut to size to accommodate individual configurations
- No hole drilling required in the glass

CAT. NO.	MOUNTING	FINISH	LENGTH	1	5
SUP06CH	Wall to Glass	Chrome	1m	£35.85	£32.45
SUP06BN	Wall to Glass	Brushed Nickel	1m	£40.60	£36.95

*Minimum order: 1 each. Price based on an order quantity of 5 each (CAT. NO. SUP06CH). Price includes 10% discount. Special discount available from 1st February to 30th April 2016.



SAVE 10%

CRL FRAMELESS SHOWER DOOR FIXED PANEL GLASS-TO-GLASS SUPPORT BAR

FROM ONLY **£41.70***

- For 6mm to 8mm glass
- 19mm diameter tubular brass bar
- May be used as an alternative to CRL header kits to secure fixed panels and provide safety
- Provides fixed panel support for enclosures not going to ceiling
- Simply cut to size to accommodate individual configurations
- No hole drilling required in the glass

CAT. NO.	MOUNTING	FINISH	LENGTH	1	5
SUP26CH	Glass to Glass	Chrome	1m	£49.50	£44.80
SUP26BN	Glass to Glass	Brushed Nickel	1m	£45.85	£41.70

*Minimum order: 1 each. Price based on an order quantity of 5 each (CAT. NO. SUP26BN). Price includes 10% discount. Special discount available from 1st February to 30th April 2016.



SAVE 10%

CRL SHOWER ENCLOSURE SUPPORT BARS

FROM ONLY **£11.19***

- For fabricating glass-to-glass or wall-to-glass support bars
- 19 mm diameter straight rod
- No glass fabrication required
- Polished chrome finish

CAT. NO.	LENGTH	FINISH	1	6
S1CH	1m	Chrome	£12.39	£11.19
S2CH	1.3m	Chrome	£16.00	£14.55
S80CH	2.03m	Chrome	£31.90	£28.90

*Minimum order: 1 each. Price based on an order quantity of 6 each (CAT. NO. S1CH). Price includes 10% discount. Special discount available from 1st February to 30th April 2016.



SAVE 10%

CRL CHROME SUPPORT BAR BRACKETS AND FITTINGS

- Components for the fabrication of custom support bars to meet your exact needs
- All will accept S1, S2, or S80 round support bars

FROM ONLY **£3.39***

CAT. NO.	DESCRIPTION	GLASS THICKNESS	1	6
S3CH	Wall or Ceiling Bracket	-	£6.20	£5.59
S4CH	Adjustable U-Bracket	6mm to 8mm	£12.15	£11.00
S5CH	Adjustable U-Bracket	10mm to 12mm	£12.15	£11.00
S6CH	Movable U-Bracket	6mm to 8mm	£7.80	£7.05
S7CH	Movable U-Bracket	10mm to 12mm	£8.00	£7.29
S8CH	90° Corner Bracket	-	£6.95	£6.29
S9CH	Vertical Support Bracket	6mm to 8mm	£6.95	£6.29
S910CH	Vertical Support Bracket	10mm to 12mm	£6.95	£6.29
S12CH	Wall Mount Fitting	-	£3.75	£3.39
S13CH	Glass Mount Fitting	6mm to 12mm	£7.55	£6.85
S4VCH	Shower Stabilizer	8mm to 12mm	£8.60	£8.00
S6VCH	Shower Stabilizer	8mm to 12mm	£8.60	£8.00

*Minimum order: 1 each. Price based on an order quantity of 6 each (CAT. NO. S12CH). Price includes 10% discount. Special discount available from 1st February to 30th April 2016.



CAT. NO. S3CH



CAT. NO. S4CH



CAT. NO. S5CH



CAT. NO. S6CH

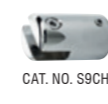

CAT. NO. S7CH



CAT. NO. S8CH



CAT. NO. S9CH



CAT. NO. S910CH

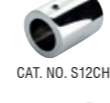

CAT. NO. S12CH



CAT. NO. S13CH



CAT. NO. S4VCH



CAT. NO. S6VCH

SAVE 10%

CRL CHROME SUPPORT BAR COMPLETE SET OFFER

SAVE 10%

- Slim-line fittings for a streamlined profile
- Wall-to-glass hardware set for 6 to 8mm glass



ONLY **£25.50***

CAT.NO. SUP06CHSET

SET INCLUDES:



CAT. NO. S1CH
Support Bar
Diameter- 19mm
Length- 1m



CAT. NO. S12CH
Slim Line Wall Mount Fitting



CAT. NO. S4CH
Support Bar U-Bracket

YOU MAY ALSO NEED...

CRL SUPER TIP DRILL BIT

- Especially suited for drilling granite, marble, and tile
- Designed for hammer or rotary drills only

NEW!

FROM ONLY **£3.90***

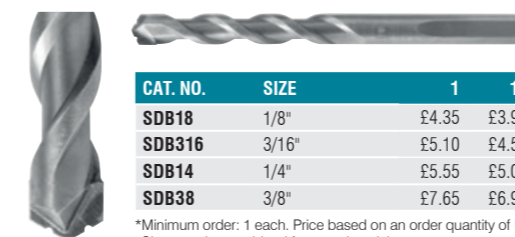

CAT. NO.	SIZE	1	12
SDB18	1/8"	£4.35	£3.90
SDB316	3/16"	£5.10	£4.55
SDB14	1/4"	£5.55	£5.05
SDB38	3/8"	£7.65	£6.90

*Minimum order: 1 each. Price based on an order quantity of 12 each (CAT. NO. SDB18). Sizes can be combined for quantity pricing.

*Minimum order: 1 each. Price based on an order quantity of 6 each. Price includes 10% discount. Special discount available from 1st February to 30th April 2016.

Shower Support Bars

CRL SQUARE SUPPORT BARS

- Square tubing matches geometry of many popular CRL hinges
- Provides fixed panel support for enclosures not going to the ceiling
- No hole drilling required in glass
- 19mm square tubing

CAT. NO.	FINISH	LENGTH	1	6
SQ59CH	Chrome	1.5m	£34.15	£30.95
SQ59BN	Brushed Nickel	1.5m	£34.15	£30.95
SQ39CH	Chrome	1m	£22.25	£20.15
SQ39BN	Brushed Nickel	1m	£21.25	£19.25

*Minimum order: 1 each. Price based on an order quantity of 6 each (CAT. NO. SQ39BN). Price includes 10% discount. Special discount available from 1st February to 30th April 2016.



CRL BRACKETS FOR SQUARE SUPPORT BARS

- Square tubing matches geometry of many popular CRL hinges
- Provides fixed panel support for enclosures not going to the ceiling
- For 6 to 8mm glass



CAT. NO.	FINISH	DESCRIPTION	1	6
SQ46CH	Chrome	Wall Mount Bracket	£6.05	£5.45
SQ46BN	Brushed Nickel	Wall Mount Bracket	£6.05	£5.45
SQ45CH	Chrome	Adjustable Corner Bracket	£16.75	£13.95
SQ45BN	Brushed Nickel	Adjustable Corner Bracket	£16.75	£13.95
SQ43CH	Chrome	Movable Bracket	£6.25	£5.70
SQ43BN	Brushed Nickel	Movable Bracket	£6.25	£5.70
SQ41CH	Chrome	Swiveling U-Bracket	£10.25	£9.30
SQ41BN	Brushed Nickel	Swiveling U-Bracket	£10.25	£9.30

*Minimum order: 1 each. Price based on an order quantity of 6 each (CAT. NO. SQ46CH). Price includes 10% discount. Special discount available from 1st February to 30th April 2016.



Slimline Square Bars

For 6 to 8mm glass

CRL SQUARE SUPPORT BAR

- Square tubing matches geometry of many popular CRL hinge styles
- Provides fixed panel support for enclosures not going to the ceiling
- No glass fabrication is required
- 15mm slimline square tubing

CAT. NO.	FINISH	LENGTH	1	12
SQJ39CH	Polished Chrome	1m	£26.25	£23.65

*Minimum order: 1 each. Price based on an order quantity of 12 each.



CRL SWIVELING GLASS U-BRACKET

- For 6 to 8 mm glass
- Slimline square tubing matches geometry of many popular CRL hinges
- Provides fixed panel support for enclosures not going to the ceiling
- No hole drilling required in glass

CAT. NO.	FINISH	1	6
SQJ41CH	Polished Chrome	£7.15	£6.45

*Minimum order: 1 each. Price based on an order quantity of 6 each.



CRL SWIVELING FLUSH MOUNTED U-BRACKET

- Slimline square tubing matches geometry of many popular CRL hinges
- Provides fixed panel support for enclosures not going to the ceiling
- No hole drilling required in glass

FROM ONLY
£10.35*



CAT. NO.	FINISH	1	6
SQJ41DCH	Polished Chrome	£11.45	£10.35

*Minimum order: 1 each. Price based on an order quantity of 6 each.

CRL MOVABLE BRACKET

- Slimline square tubing matches geometry of many popular CRL hinges
- Provides fixed panel support for enclosures not going to the ceiling
- No hole drilling required in glass

FROM ONLY
£3.95*



CAT. NO.	FINISH	1	6
SQJ43CH	Polished Chrome	£4.40	£3.95

*Minimum order: 1 each. Price based on an order quantity of 6 each.

CRL WALL MOUNT BRACKET

- Slimline square tubing matches geometry of many popular CRL hinges
- Provides fixed panel support for enclosures not going to the ceiling
- No hole drilling required in glass

FROM ONLY
£4.30*



CAT. NO.	FINISH	1	6
SQJ46CH	Polished Chrome	£4.75	£4.30

*Minimum order: 1 each. Price based on an order quantity of 6 each.

CRL ADJUSTABLE WALL MOUNT BRACKET

- Slimline square tubing matches geometry of many popular CRL hinges
- Provides fixed panel support for enclosures not going to the ceiling
- No hole drilling required in glass

FROM ONLY
£9.40*



CAT. NO.	FINISH	1	6
SQJ49CH	Polished Chrome	£10.40	£9.40

*Minimum order: 1 each. Price based on an order quantity of 6 each.

CRL "T" JUNCTION BRACKET

- New square tubing matches geometry of many popular CRL hinges
- Provides fixed panel support for enclosures not going to the ceiling
- No hole drilling required in glass

FROM ONLY
£8.40*



CAT. NO.	FINISH	1	6
SQJ50CH	Polished Chrome	£9.35	£8.40

*Minimum order: 1 each. Price based on an order quantity of 6 each.

CRL ALTEA SERIES SHOWER HINGES AND ACCESSORIES



Simple and elegant...

Introducing the Altea Series, an elegant shower hinge and clamp range designed for quick and easy installation, with simple elements and little embellishment for a minimalistic appearance.

- Cover plates hide fixing screws for a sleek modern design
- Solid brass hinge constructions ideal for shower environments
- Easy to install, adjust and fix
- Mirror quality chrome plating for the perfect premium quality look
- Free swinging design
- Only low-cost drilled holes are required in the glass fabrication
- Quick and easy sealing of the shower door; shower seals are attached to the door, top to bottom without needing to cut around the hinge
- Tested over 40,000 open and close cycles without issue
- Suitable for 6mm to 10mm toughened safety glass

Great Value

FROM ONLY £5.40*



CAT. NO. ALTO37CH



CAT. NO. ALT092CH



CAT. NO. ALT180CH



CAT. NO. ALTC90CH



CAT. NO. ALTC337CH



CAT. NO. ALTC380CH



CAT. NO. ALTSBK2CH

CAT. NO.	FINISH	DESCRIPTION	1	10	50
ALTO37CH	Chrome	90° Glass to Wall Hinge	£17.95	£14.95	£13.85
ALT092CH	Chrome	90° Glass to Glass Hinge	£25.55	£21.25	£19.65
ALT180CH	Chrome	180° Glass to Glass Hinge	£23.30	£19.40	£17.90
ALTC90CH	Chrome	90° Glass to Wall Clamp	£10.75	£8.95	£8.25
ALTC337CH	Chrome	Adjustable Glass to Wall Clamp	£12.15	£10.15	£9.35
ALTC380CH	Chrome	Adjustable Glass to Glass Clamp	£14.55	£12.10	£11.20
ALTSBK2CH	Chrome	28 x 28mm Back-to-Back Square Knob	£7.05	£5.85	£5.40

*Minimum order: 1 each. Price based on an order quantity of 50 each (CAT. NO. ALTSBK2CH).

All hinges include removable cover plates for an elegant finish

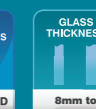

Shower U-Channels

CRL ALUMINIUM U-CHANNEL FOR 10MM GLASS

- May be used alone or with regular depth U-Channel
- Wet glazed with clear silicone to secure glass
- Available in 2.49m and 3.65m stock lengths
- Available in up to 17 finishes - see crlaurence.co.uk

SAVE 10%

FROM ONLY £6.15* PER LENGTH

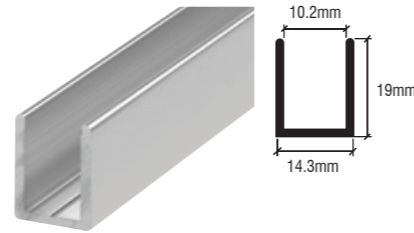

CAT. NO. SD38



CAT. NO. SDCR38

NOTE: U-channels are also available for 8 and 12mm glass. Please contact our technical advisers.

CAT. NO.	FINISH	LENGTH	DEPTH	1	10	40	50	80	100	120	150
SD38BA	Brite Anodised	2.49m	19mm	£8.90	£8.00	£7.30	-	£6.65	-	£6.15	-
SD38BN	Brushed Nickel	2.49m	19mm	£9.20	£8.25	£7.50	-	£6.89	-	£6.35	-
SD3812BA	Brite Anodised	3.65m	19mm	£13.09	£11.75	£10.69	-	£9.80	-	£9.35	-
SD3812BN	Brushed Nickel	3.65m	19mm	£13.55	£12.17	£11.06	-	£10.14	-	£9.36	-
SDCR38BA	Brite Anodised	2.49m	9.5mm	£9.95	£8.85	-	£7.90	-	£7.25	-	£6.65
SDCR38BN	Brushed Nickel	2.49m	9.5mm	£13.15	£11.70	-	£10.50	-	£9.55	-	£8.75

*Minimum order: 1 each. Price based on an order quantity of 120 each (CAT. NO. SD38BA). Price includes 10% discount. Special discount available from 1st February to 30th April 2016. All U-Channel can be combined for quantity pricing.

CRL ALUMINIUM U-CHANNEL FOR RECESSED GLASS

- For 10 or 12mm glass
- Ideal for recessing glass and creating the "all-glass" appearance
- Top of channel angled to assist with water deflection
- Top lip helps cover edge of tile
- 2.49m stock lengths

FROM ONLY £8.40* PER LENGTH

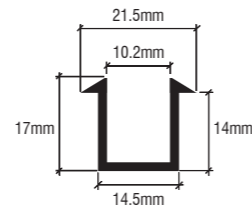

NEW!

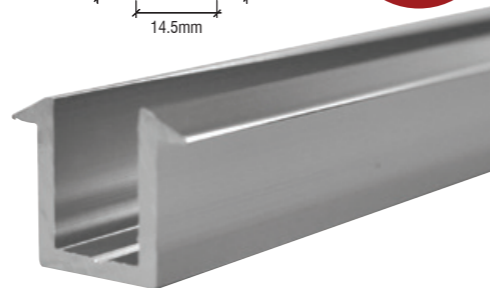

CAT. NO.	FINISH	GLASS	1	10	40	80	120
SDCF38BA	Brite Anodised	10mm	£12.30	£11.50	£10.80	£10.15	£9.19
SDCF38BN	Brushed Nickel	10mm	£12.60	£11.75	£11.10	£10.35	£9.40
SDCF12BA	Brite Anodised	12mm	£11.29	£10.50	£9.90	£9.30	£8.40
SDCF12BN	Brushed Nickel	12mm	£11.50	£10.79	£10.15	£9.50	£8.60

*Minimum order: 1 each. Price based on an order quantity of 120 each (CAT. NO. SDCF12BA). All U-Channel can be combined for quantity pricing.

CRL DRY GLAZE U-CHANNEL WITH VINYL FOR 8 AND 10MM GLASS

- Clear vinyls secure glass in channel and eliminate the need for messy silicone
- Recess in bottom channel hides caulk line
- DUC38 can be used with 8mm glass where RV8DUC rigid vinyl is used (available separately)
- 2.49m stock lengths
- Individually packaged

FROM ONLY £12.40* PER LENGTH

NOTE: glass is not included

CAT. NO.	FINISH	GLASS	1	10	50
DUC516BA	Brite Anodised	8mm	£16.05	£14.99	£13.50
DUC516BN	Brushed Nickel	8mm	£18.25	£16.60	£15.25
DUC38BA	Brite Anodised	10mm	£15.25	£13.70	£12.40
DUC38BN	Brushed Nickel	10mm	£17.09	£15.50	£14.20

*Minimum order: 1 each. Price based on an order quantity of 50 each (CAT. NO. DUC38BA). All U-Channel can be combined for quantity pricing.

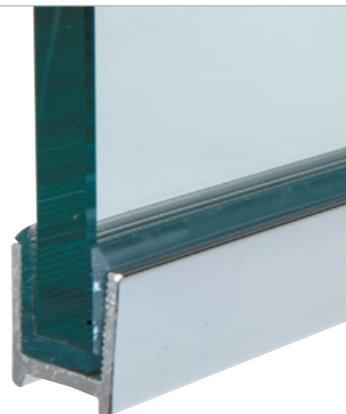
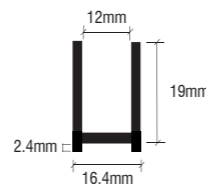

THE PERFECT FINISH

Whatever the project

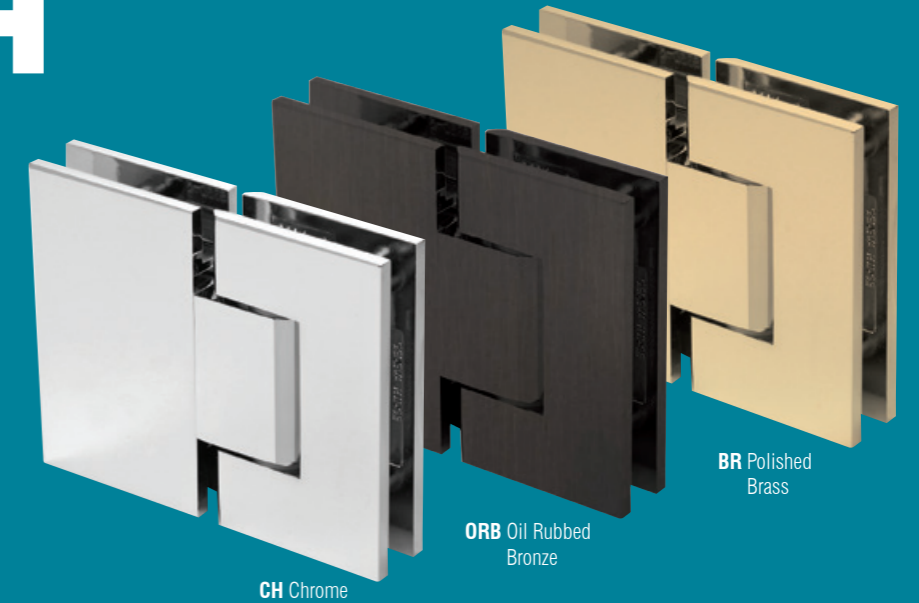

Note: Not all finishes are available for every product. Please call or consult crlaurence.co.uk for product specific colour options.

ABN Antique Brushed Nickel	ABR Antique Brass			
CH Polished Chrome	SC Satin Chrome (Matte)	BSC Brushed Satin Chrome	BN Brushed Nickel	PN Polished Nickel
SN Satin Nickel	BR Polished Brass	SB Satin Brass	UBR Ultra Brass	ORB Oil Rubbed Bronze
ABRZ Antique Bronze	BBRZ Brushed Bronze	ABCO Antique Brushed Copper	PCO Polished Copper	BCO Brushed Copper
GM Gun Metal	GP Gold Plated	WH White	BL Black	R Red



KEEP ON ROLLING...



CRL CONTINENTAL STYLE PRE-CUT SECURITY TRACK ASSEMBLY

SAVE 10%

- Designed for 5mm and 6mm glass
- Pre-cut assemblies in three lengths

FROM ONLY £28.45*



CRL ROLLER TRACK SYSTEM

CRL TOP TRACK

- Polished aluminium finish
- 21mm wide, 18mm high
- Perfect for showcases and display cabinets
- Designed for 6mm toughened glass
- Simple 'lift and drop' glass installation
- Top channel can be used as side jambs or for a surround frame



FROM ONLY £7.90* PER LENGTH

CAT. NO.	LENGTH	1	20	40
16790	2m	£9.25	£8.55	£7.90
16795	4m	£18.20	£16.70	£15.50

*Minimum order: 1 each. Price based on an order quantity of 40 lengths of (CAT. NO. 16790). All roller track can be combined for quantity pricing. Packing charge added to orders of fewer than four lengths.

CRL BOTTOM TRACK WITH ROLLERS

- Polished aluminium finish
- 21mm wide, 18mm high
- Perfect for showcases and display cabinets
- Designed for 6mm toughened glass
- Smooth operating nylon rollers are built into the lower track
- Simple 'lift and drop' glass installation

FROM ONLY £20.40* PER LENGTH

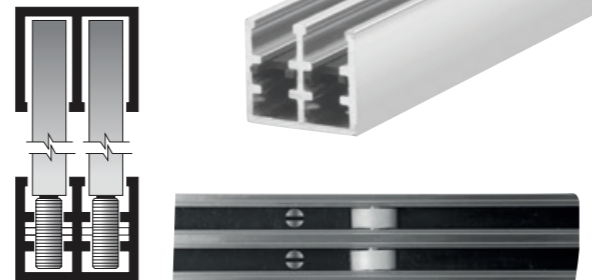

CAT. NO.	LENGTH	1	20	40
16780	2m	£22.65	£21.45	£20.40
16785	4m	£43.20	£40.95	£38.90

*Minimum order: 1 each. Price based on an order quantity of 40 lengths of (CAT. NO. 16780). All roller track can be combined for quantity pricing. Packing charge added to orders of fewer than four lengths.



CRL End Caps for use with H-Bar CAT. NO. DV148SC FROM ONLY £1.00** EACH (sold separately)

CAT. NO.	FINISH	LENGTH	1	10
CTA36A	Satin Anodised	914mm	£31.85	£28.45
CTA48A	Satin Anodised	1219mm	£35.95	£32.05
CTA72A	Satin Anodised	1829mm	£44.10	£39.30

* Minimum order: 1 each. Price based on an order quantity of 10 each (CAT. NO. CTA36A). Price includes 10% discount. Special discount available from 1st February to 30th April 2016. Track assembly can be combined for quantity pricing.
** Minimum order: 1 each. Price based on an order quantity of 100 each (CAT. NO. DV148SC). Price includes 10% discount. Special discount available from 1st February to 30th April 2016.

Included: CAT. NO. 6306 Anti-lift clip and CAT. NO. 0681SC End cap lock

YOU MAY ALSO NEED...

CRL THREADED FINGER PULL FOR GLASS DOORS

SAVE 10%

FROM ONLY £1.05*

- Designed for 'all glass' showcase and cabinet doors
- Requires drilling a 22mm hole in glass
- Easy to install in glass from 6mm to 8mm thick

CAT. NO. KV836



* Minimum order: 1 each. Price based on an order quantity of 50 each (CAT. NO. KV836). Price includes 10% discount. Special discount available from 1st February to 30th April 2016.

Door Hardware

The CRL Compact-X System has been successfully cycle tested for 100,000 cycles according to EU norm EN1527.

CRL BEST SLIDING DOOR SYSTEM

CRL COMPACT-X SLIDING DOOR SYSTEM

CRL COMPACT-X is a compact sliding solution for frameless glass panels, combining the latest technology with an attractive minimalist design. The system is quick and easy to install, and is particularly appropriate for domestic and commercial applications, where it integrates seamlessly into any design.

ENHANCED DOUBLE SOFT CLOSE SYSTEM

NEW!



CRL SINGLE SLIDING DOOR KIT

- For 8 and 10mm glass
- 70kg weight capacity
- Complete with double soft close
- Minimum door width: 635mm
- Ceiling or wall mount

FROM ONLY **£145.65*** PER KIT

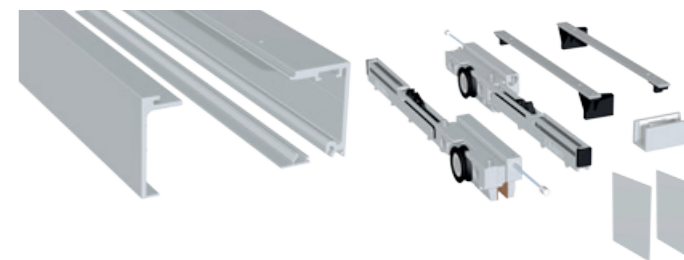

CAT. NO.	FINISH	LENGTH	1	6	12
EUCRLX2SA	Satin Anodised	2m	£172.10	£157.75	£145.65
EUCRLX2BN	Brushed Nickel	2m	£187.60	£171.95	£158.75
EUCRLX3SA	Satin Anodised	3m	£196.25	£179.85	£166.00
EUCRLX3BN	Brushed Nickel	3m	£217.75	£199.65	£184.25

*Minimum order: 1 each. Price based on an order quantity of 12 each (CAT. NO. EUCRLX2SA)

CRL SINGLE SLIDING DOOR WITH FIXED PANEL KIT

- For 8 and 10mm glass
- 70kg weight capacity
- Complete with double soft close
- Minimum door width: 635mm
- Ceiling or wall mount

FROM ONLY **£199.50*** PER KIT

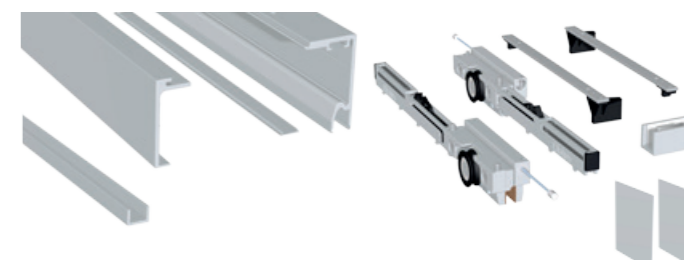

CAT. NO.	FINISH	LENGTH	1	6	12
EUCRLX3FSA	Satin Anodised	3m	£235.80	£216.15	£199.50
EUCRLX3FBN	Brushed Nickel	3m	£261.75	£239.95	£221.45
EUCRLX5FSA	Satin Anodised	5m	£253.25	£232.15	£214.30
EUCRLX5FBN	Brushed Nickel	5m	£295.25	£270.65	£249.80

*Minimum order: 1 each. Price based on an order quantity of 12 each (CAT. NO. EUCRLX3FSA)

CRL SOFTBRAKE KIT, FOR DOUBLE SLIDING OR BI-PART DOORS

- Converts single sliding door systems to double doors

FROM ONLY **£117.75*** PER SET



CAT. NO.	FINISH	LENGTH	1	6	12
EUCRLXSBK1TSA	Satin Anodised	2m	£139.15	£127.55	£117.75
EUCRLXSBK1TBN	Brushed Nickel	2m	£142.10	£130.25	£120.25

*Minimum order: 1 each. Price based on an order quantity of 12 each (CAT. NO. EUCRLXSBK1TSA)

CRL TOP TRACK FIXING SET

- Glass wall mount point fixing kit
- Includes five counter sunk, flush mount point fixings

FROM ONLY **£44.10***



CAT. NO.	1	6	12
EUCRLXGFK1T	£52.15	£47.75	£44.10

*Minimum order: 1 set. Price based on an order quantity of 12 sets.

You may also need:
CAT. NO. SERNHP2BS
CRL Brushed Stainless Steel Thru-Glass Pull Handle (for 8 to 10mm glass)



Sliding Door System

Railing Hardware



CRL PRE-ASSEMBLED POST RAILING SYSTEM

CRL HAND RAIL TUBING

- 50.8mm diameter tubing
- For use with 50.8mm European post railing system
- Two architectural finishes
- 316 grade brushed stainless steel
- 1.2mm material thickness



CAT. NO.	FINISH	LENGTH	1	6
EUHR20BS	Brushed Stainless Steel	3m	£50.15	£45.50
EUHR20PS	Polished Stainless Steel	3m	£55.00	£50.00

*Minimum order: 1 each. Price based on an order quantity of 6 each (CAT. NO. EUHR20BS).

FROM ONLY
£45.50*

CRL INTERNAL CONNECTOR

- 50.8mm diameter connectors
- For use with 50.8mm European post railing system
- Used with handrail tubing
- 316 grade brushed stainless steel
- Sold individually



CAT. NO.	FINISH	1	6
EUHR20CSS	Brushed Stainless Steel	£8.45	£7.70

*Minimum order: 1 each. Price based on an order quantity of 6 each.

FROM ONLY
£7.70*

CRL 90° CORNER

- For 50.8mm diameter stainless tubing
- Used with European post railing system
- 316 grade stainless steel



FROM ONLY
£11.55*

CAT. NO.	FINISH	1	6
EUHR20HBS	Brushed Stainless Steel	£12.70	£11.55
EUHR20HPS	Polished Stainless Steel	£13.90	£12.65

*Minimum order: 1 each. Price based on an order quantity of 6 each (CAT. NO. EUHR20HBS).

CRL END CAP

- For 50.8mm diameter stainless tubing
- Used with hand rail tubing
- 316 grade stainless steel



FROM ONLY
£4.60*

CAT. NO.	FINISH	1	6
EUHR20ECBS	Brushed Stainless Steel	£5.10	£4.60
EUHR20ECPS	Polished Stainless Steel	£5.55	£5.05

*Minimum order: 1 each. Price based on an order quantity of 6 each (CAT. NO. EUHR20ECBS).

CRL FULL FLANGE

- For 50.8mm diameter stainless tubing
- 316 grade stainless steel



FROM ONLY
£14.75*



You may need:
CAT. NO. 32629
Metal Contact Cement

CAT. NO.	FINISH	1	10
EUHR20YBS	Brushed Stainless Steel	£16.25	£14.75
EUHR20YPS	Polished Stainless Steel	£16.60	£15.10

*Minimum order: 1 each. Price based on an order quantity of 10 each (CAT. NO. EUHR20YBS).

CRL POST KITS

BLANK POST / END POSTS /
CENTRE POSTS / 90° POSTS / 135° POSTS

- 1100mm high; 50.8mm diameter; 2.5mm thick
- 316 grade stainless steel
- Sold as a complete post kit
- For 10mm and 12mm glass
- Available in brushed and polished stainless steel

GRADE 316
STAINLESS
STEEL

Kit comes with: Flange, Cover Plate and Fixed Saddle Bracket.
Depending on the kit, it also comes with balustrade clamps and gaskets.

FROM ONLY
£66.30*



CAT. NO.	FINISH	HEIGHT	CONFIGURATION	1	6
EUPR42BBS	Brushed Stainless Steel	1100mm	Blank	£72.95	£66.30
EUPR42EBS	Brushed Stainless Steel	1100mm	End	£102.95	£93.60
EUPR42EPS	Polished Stainless steel	1100mm	End	£107.55	£97.75
EUPR42CBS	Brushed Stainless Steel	1100mm	Centre	£126.95	£115.40
EUPR42CPS	Polished Stainless steel	1100mm	Centre	£131.65	£119.70
EUPR42LBS	Brushed Stainless Steel	1100mm	90°	£129.45	£117.65
EUPR42LPS	Polished Stainless Steel	1100mm	90°	£134.15	£121.95
EUPR42ABS	Brushed Stainless Steel	1100mm	135°	£129.75	£117.95
EUPR42APS	Polished Stainless Steel	1100mm	135°	£134.45	£122.25

*Minimum order: 1 each. Price based on an order quantity of 6 each (CAT. NO. EUPR42BBS).



Blank Post Kit

End Post Kit



Centre Post Kit

90° Post Kit

135° Post Kit

FULL RANGE AVAILABLE IN OUR ARCHITECTURAL GLASS FIXINGS BROCHURE - EUAGF15





GET A GRIP...

CRL Z-Series Glass Clamps

For use on mezzanines, partitions, railings, and windbreaks

FOR USE WITH A WIDE RANGE OF GLASS
- FROM 6MM TO 19MM

Flat Back Clamps

- Internal or external use
- Square or round type



Radius Back Clamps

- Internal or external use
- Square or round type



Gaskets and Support Plates

- For use with our range of glass clamps



SEE THE COMPLETE RANGE

VISIT crlaurence.co.uk and search for 'Z-Series Glass Clamps' or view CAT. NO. EUAGF15, pages 18 - 23

Contact our technical advisers for more details on our architectural glass fixings

crl@crlaurence.co.uk or 00 800 0421 6144



CRL BEST SELLERS

CRL LARGE D SHAPE FLAT BACK GLASS CLAMPS

FROM ONLY **£1.65***

- For use on mezzanines, partitions, railings, and windbreaks
- Steel pin included for additional glass support
- For 8 to 12.76mm toughened or laminated glass • Sold individually

Rubber gaskets are sold separately, CAT. NO.'s EUZ8G to EUZ1276G

CAT. NO.	FINISH	SIZE	1	50	100	500
EUZFBS	Brushed Stainless	63 x 45 x 30mm	£6.25	£5.65	£5.15	£4.75
EUZFBPS	Polished Stainless	63 x 45 x 30mm	£7.40	£6.65	£5.90	£5.55
EUZFBZ	Raw Zinc	63 x 45 x 30mm	£2.15	£1.95	£1.80	£1.65
EUZFBNN	Brushed Nickel	63 x 45 x 30mm	£2.70	£2.45	£2.25	£2.00

*Minimum order: 1 each. Price based on an order quantity of 500 each (CAT. NO. EUZFBZ).

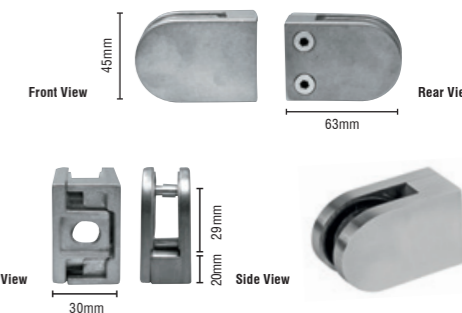

CRL LARGE D SHAPE 48.3MM RADIUS BACK GLASS CLAMPS

FROM ONLY **£4.99***

- Radius back for use with 48.3mm diameter posts
- For use on mezzanines, partitions, railings, and windbreaks
- Steel pin included for additional glass support
- For 8 to 12.76mm toughened or laminated glass
- Sold individually

Rubber gaskets are sold separately, CAT. NO.'s EUZ8G to EUZ1276G

CAT. NO.	FINISH	SIZE	1	50	100	500
EUZ48RBS	Brushed Stainless	63 x 45 x 30mm	£6.65	£5.95	£5.45	£4.99
EUZ48RPS	Polished Stainless	63 x 45 x 30mm	£7.75	£6.99	£6.35	£5.80

*Minimum order: 1 each. Price based on an order quantity of 500 each (CAT. NO. EUZ48RBN).

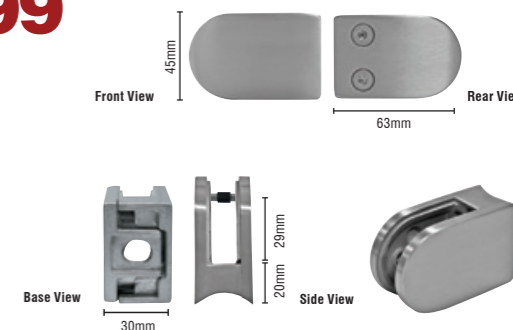

CRL SQUARE TYPE FLAT BACK GLASS CLAMPS

FROM ONLY **£2.05***

- For use on mezzanines, partitions, railings, and windbreaks
- Side plates for use with laminated glass
- For 8 to 12.76mm toughened or laminated glass
- Safety pin included
- Sold individually

Rubber gaskets are sold separately, CAT. NO.'s EUZLS6GL to EUZLS1276GL

CAT. NO.	FINISH	SIZE	1	50	100	500
EUZLSFBBSL	Brushed Stainless	55 x 55 x 35mm	£10.45	£9.45	£8.55	£7.85
EUZLSFBZL	Raw Zinc	55 x 55 x 35mm	£2.90	£2.70	£2.19	£2.05

*Minimum order: 1 each. Price based on an order quantity of 500 each (CAT. NO. EUZLSFBZL).

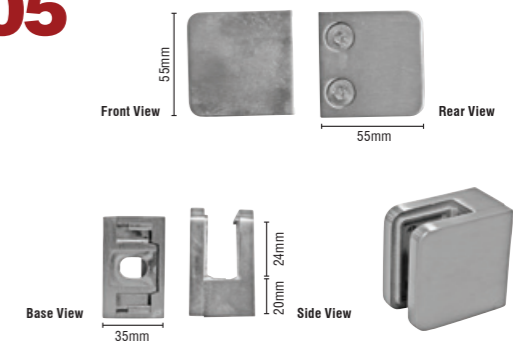

CRL SQUARE TYPE 42.4MM RADIUS BACK GLASS CLAMPS

FROM ONLY **£2.05***

- Radius back for use with 42.4mm diameter posts
- For use on mezzanines, partitions, railings, and windbreaks
- Side plates for use with laminated glass included
- For 6 to 12.76mm toughened or laminated glass
- Safety pin included
- Sold individually

Rubber gaskets are sold separately, CAT. NO.'s EUZLS6GL to EUZLS1276GL

CAT. NO.	FINISH	SIZE	1	50	100	500
EUZLS42RBSL	Brushed Stainless	55 x 55 x 35mm	£10.45	£9.45	£8.55	£7.85
EUZLS42RZL	Raw Zinc	55 x 55 x 35mm	£2.90	£2.70	£2.19	£2.05

*Minimum order: 1 each. Price based on an order quantity of 500 each (CAT. NO. EUZLS42RZL).

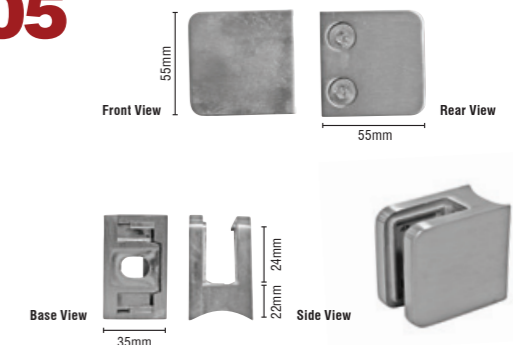

TAPER-LOC X
 DRY GLAZE RAILING SYSTEM



Order your free copy
 from taper-loc.co.uk



Install glass railings with ease...

TAPER-LOC®

- 50% faster to install than alternatives
- Save Time and Money - The horizontal TAPER-LOC® design allows the system to be adjusted, dismantled and re-set
- Meets BS 6180: 2011 requirements
- For use with monolithic and laminated toughened glass
- Easy installation with one compact installation/removal tool



**Simple.
 Fast.
 Unique.**

Frameless Glass Balustrade System

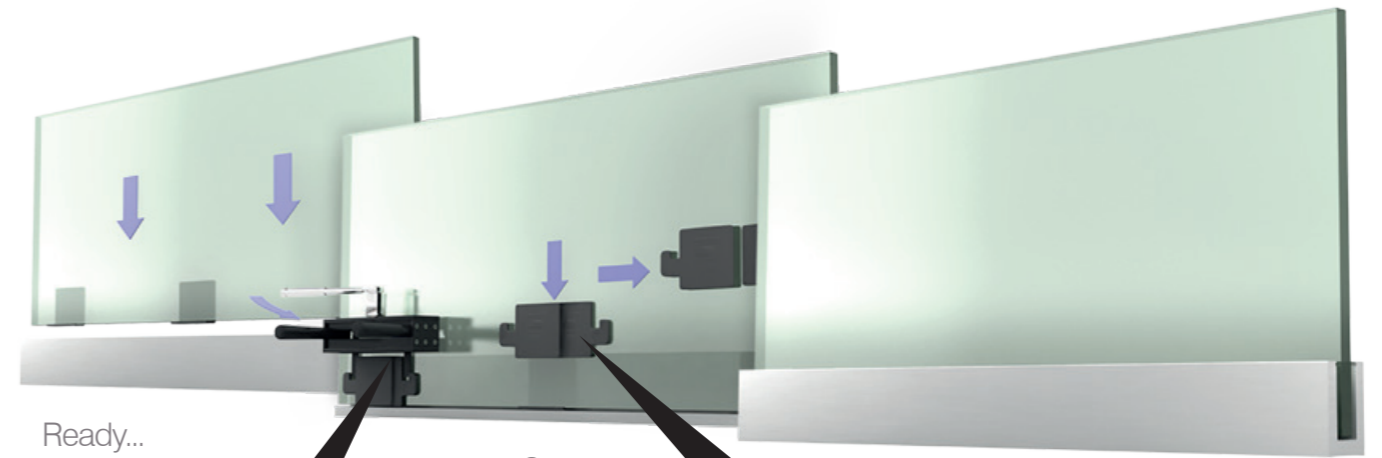

The TAPER-LOC® Installation/Removal Tool compresses the Tapers together to lock the glass in place

TAPER-LOC® Tapers insert into the Aluminium Base Shoe

Done.



U.S. Patent Numbers 8,122,654 and 8,201,366 and Commonwealth of Australia Patent Numbers 2008207524 and 2012202256

For more information, visit www.taper-loc.co.uk
 Ask about our new TAPER-LOC® X1 System for use with laminated toughened glass

ENL To see a demonstration, visit www.taper-loc.co.uk





European HQ

Manchester

Charles Babbage Avenue, Kingsway Business Park, Rochdale, OL16 4NW, England



Germany

Stuttgart

Boschstrasse 7
D-74360 Ilsfeld, Germany



Denmark

Copenhagen

Stamholmen 70 Unit B,
DK-2650 Hvidovre, Denmark

The Complete Collection

- EUAB12UK for the Binder with the following selection of brochures:
 - EUTL14 TAPER-LOC® Frameless Glass Balustrade System
 - DH12UK Door Hardware & Partitioning Systems for Glass
 - RS12UK Aluminium Railing & Windscreen Systems
 - GA14DEUK Glass Awnings Brochure
 - SDH12UK Shower Door Hardware
 - OPS15DEUK Office Partition System
 - EU6K14UK Hydrophobic Surface Protection System
 - CAB0UK14 Cabo Soft Close Shower Door System
- EUAB12 for the Binder only

The ring binder enables you to add new brochures as they are published.



For your copy call: **00 800 0421 6144** or email: **CRL@crlaurence.co.uk**

For more information Freephone 00 800 0421 6144 (UK & Europe) | Freefax 00 800 0262 3299

