



Ref: GS0916UKA
AUTUMN 2016

glass

PRODUCT SHOWCASE

Tools & Supplies
for the glass shop

glasstec SPECIAL EDITION



HUGE SAVINGS INSIDE!



VIEW ALL PRODUCT RANGES ONLINE
crlaurence.co.uk



NEW AND POPULAR PRODUCTS AT DISCOUNT PRICES
ORDER TODAY FROM THE GLOBAL MARKET LEADER



Your CRL UK Contacts



SIMON BOOCOCK
Managing Director



STEVE BYROM
Technical Sales
steve_byrom@crlaurence.co.uk



RICHARD LAKE
UK Sales Manager
richard_lake@crlaurence.co.uk



MARK TEASDALE
Technical Sales
mark_teadale@crlaurence.co.uk



RICHARD WESLEY
Internal Sales Manager
richard_wesley@crlaurence.co.uk



STEPHEN BRAME
Internal Sales
stephen_brame@crlaurence.co.uk



PETER CASEY
Technical Sales Manager
peter_casey@crlaurence.co.uk



LYNDSEY PERRINS
Internal Sales
lyndsey_perrins@crlaurence.co.uk



LISA ZEBICHE
Marketing Manager
lisa_zebiche@crlaurence.co.uk



LOUISA HALL
Internal Sales
louisa_hall@crlaurence.co.uk



STEVEN GREGORY
Technical Sales
steven_gregory@crlaurence.co.uk



GEMMA HOWARTH
Marketing Co-ordinator
gemma_howarth@crlaurence.co.uk



EMMA MANSFIELD
Technical Sales
emma_mansfield@crlaurence.co.uk



**“We have
the world’s
largest supply
of glazing
accessories”**



Contents



Glass and Glazing Tools and Supplies

- 4-7 Glass Cutting
- 7 Glazier's Pliers
- 8 Protective Gloves and Wrist Guards
- 9 Measuring Tools
- 10-11 Belt Sander and Abrasives
- 11 Cordless Diamond Glass Saw
- 11 Scratch Polisher
- 12-14 Vacuum Lifters and Frames
- 15 Glass Transport and Handling
- 16-17 Sealants and Dispensing Tools
- 18-19 Glazing and Utility Knives
- 20 Razor Blades and Holders
- 21 Glass Setting and Framing Tools
- 22 Glazing Blocks and Tools
- 23 Glass Protection Supplies



Mirror and Shower Essentials

- 25 Mirror Mastics and Adhesives
- 25-27 Mirror Fixing Hardware
- 26 Aluminium J-Bar
- 26-27 Adhesive Tapes
- 28-29 Glass Cleaning and Protection
- 30-31 Aluminium U-Channel
- 32 Frameless Shower Hinges
- 33 Frameless Shower Knobs and Pulls
- 34-35 Frameless Shower Support Bars
- 36-37 Shower Door Wipes and Seals
- 38-39 Glass Shelf and Cabinet Hardware
- 40-42 Shower Enclosure Kits



Glass Railing Hardware

- 44-45 TAPER-LOC® Glass Railing System
- 46-48 Glass Clamps



Commercial Hardware

- 49-51 Glass Wall Partition Hardware
- 52-53 All-Glass Entrance Door Hardware
- 54-55 Oil Dynamic Hinges for Glass Doors



GLASS AND GLAZING TOOLS AND SUPPLIES



CRL TOYO® SUPERCUTTER® STRAIGHT HEAD OIL CUTTER

- Equipped with TOYO® patented Tap Wheel technology
- Precise grinding technology improves cutting
- Cemented carbide wheel and axle gives improved cutting life
- Brass or plastic straight end handles
- 140 degree hone angle

FROM ONLY
£10.95*

SAVE
20%

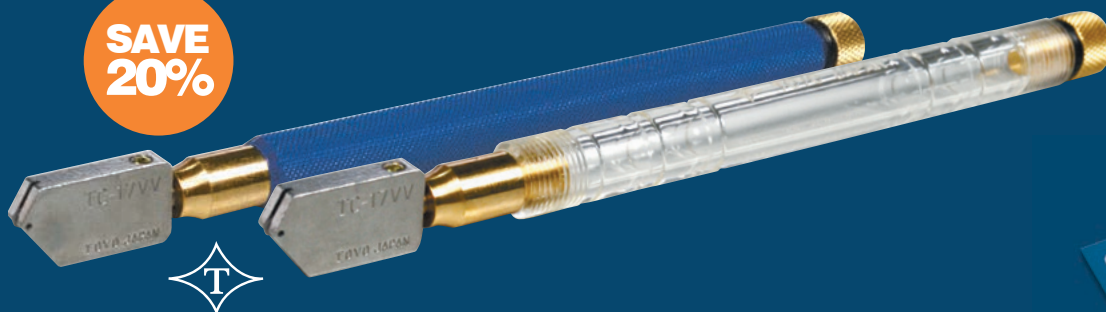

Replacement head
TC17VVH

| CAT. NO. | DESCRIPTION | 1 | 6 | 12 |
|----------|------------------|--------|--------|--------|
| TC17VVB | Brass Handle | £13.75 | £13.10 | £11.25 |
| TC17VVP | Plastic Handle | £13.35 | £12.75 | £10.95 |
| TC17VVH | Replacement head | £8.90 | £8.50 | £7.30 |

* Minimum order: 1 each. Price based on an order quantity of 12 each (CAT. NO. TC17VVP). Price includes 20% discount. Special discount available from 1st September to 31st December 2016. Supercutter® and Tap Heads are not interchangeable. Oil type glass cutters can be combined for quantity pricing.

EVEN MORE GREAT PRODUCTS

VISIT crlaurence.co.uk and view CAT. NO. GG2014A





CRL TOYO® ORIGINAL SUPERCUTTER®

- Premium quality
- Brass or plastic straight end handles
- 140 degree hone angle carbide wheels
- For cutting 4 to 8mm glass

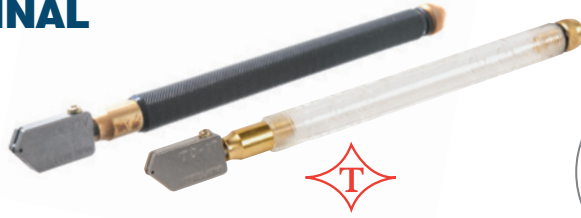

WORLD FAMOUS BEST SELLER

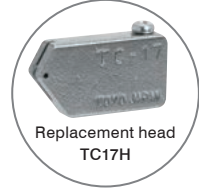

Replacement head TC17H

SAVE 20%

| CAT. NO. | DESCRIPTION | 1 | 6 | 12 |
|----------|---------------------------------|--------|--------|--------|
| TC17B | Brass Handle | £13.75 | £13.10 | £11.25 |
| TC17P | Plastic Handle | £13.40 | £12.80 | £11.00 |
| TC17H | Replacement Cutting Head - Wide | £8.95 | £8.55 | £7.30 |

FROM ONLY **£11.00***

*Minimum order: 1 each. Price based on an order quantity of 12 (CAT. NO. TC17P). Price includes 20% discount. Special discount available from 1st September to 31st December 2016.

CRL TOYO® STRAIGHT "DRY WHEEL" SUPERCUTTER®

- Black handle and wide straight head
- Moulded handle for positive grip
- 140 degree hone angle, long lasting TOYO® carbide wheel
- For cutting 4 to 6mm glass



THE ORIGINAL AND BEST



Replacement head TC20H

SAVE 20%

| CAT. NO. | DESCRIPTION | 1 | 6 | 12 |
|----------|---------------------------------|-------|-------|-------|
| TC20 | Brass Handle | £9.30 | £8.90 | £7.65 |
| TC20H | Replacement Cutting Head - Wide | £8.05 | £7.65 | £6.55 |

FROM ONLY **£7.65***

*Minimum order: 1 each. Price based on an order quantity of 12 (CAT. NO. TC20). Price includes 20% discount. Special discount available from 1st September to 31st December 2016.

CRL TOYO® COMFORT-GRIP SUPERCUTTER® WITH PATTERN HEAD

- Straight end handle
- Self-oiling
- Premium quality
- For cutting 3 to 6mm glass

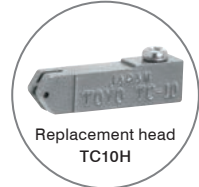

Replacement head TC10H

SAVE 20%

| CAT. NO. | DESCRIPTION | 1 | 6 | 12 |
|----------|--------------------------|-------|-------|-------|
| TC1P | Comfort-Grip Supercutter | £9.90 | £9.45 | £8.10 |
| TC10H | Replacement Cutting Head | £8.90 | £8.50 | £7.30 |

FROM ONLY **£8.10***

*Minimum order: 1 each. Price based on an order quantity of 12 (CAT. NO. TC1P). Price includes 20% discount. Special discount available from 1st September to 31st December 2016.

CRL TOYO® THOMAS-GRIP SUPERCUTTER® WITH PATTERN HEAD

- Pattern head model
- Self-oiling
- Unique grip
- Available in a range of coloured handles
- For cutting 3 to 6mm glass



Replacement head TC10H

SAVE 20%

| CAT. NO. | DESCRIPTION | 1 | 6 | 12 |
|----------|--------------------------|--------|--------|-------|
| TC9PR | Thomas-Grip Supercutter | £11.25 | £10.75 | £9.25 |
| TC10H | Replacement Cutting Head | £8.90 | £8.50 | £7.30 |

FROM ONLY **£9.25***

*Minimum order: 1 each. Price based on an order quantity of 12 (CAT. NO. TC9PR). Price includes 20% discount. Special discount available from 1st September to 31st December 2016.



CRL TOYO® TAP WHEEL™ THICK GLASS SUPERCUTTER®

- Standard wide head or optional pattern head
- Pistol grip
- Smooth cutting action for glass up to 19mm thick
- Automatic self-oiling action

| CAT. NO. | DESCRIPTION | 1 | 6 | 12 |
|----------|--------------------------------------|--------|--------|--------|
| TC600SVB | Thick Glass Supercutter® Cutter-Wide | £17.30 | £16.45 | £14.15 |
| TC600HPV | Pattern Replacement Head | £13.70 | £13.10 | £11.20 |
| TC600HSV | Wide Replacement Head | £13.70 | £13.10 | £11.20 |

*Minimum order: 1 each. Price based on an order quantity of 12 (CAT. NO. TC600SVB).
Price includes 20% discount. Special discount available from 1st September to 31st December 2016.

FROM ONLY
£14.15*



SAVE
20%



CAT. NO. TC600HPV CAT. NO. TC600HSV

CRL HEAVY-DUTY 6 WHEEL GLASS CUTTER

- Best selling glass cutter in Europe
- Popular 6 wheel design for extended use life
- For cutting 3 to 10mm glass

| CAT. NO. | DESCRIPTION | 1 | 6 | 12 | 60 |
|----------|----------------------|--------|--------|--------|--------|
| G100 | 6 Wheel Glass Cutter | £70.35 | £65.65 | £62.50 | £59.70 |

*Minimum order: 1 each. Price based on an order quantity of 60.

FROM ONLY
£59.70*



CRL PRECISION CIRCLE CUTTER

- Our most popular circle cutter
- Precision action 6-wheel turret
- Vacuum cup base
- Larger models for diameters up to 1981mm available online at crlaurence.co.uk

| CAT. NO. | DESCRIPTION | 1 |
|----------|-----------------|--------|
| 511CC | 63.5mm to 610mm | £36.95 |
| 512CC | 63.5mm to 813mm | £40.75 |

*Minimum order: 1 each. Price based on an order quantity of 1 (CAT. NO. 511CC).

FROM ONLY
£36.95*



CRL EVAPORATING VAPOURMAX 53 CUTTING FLUID

- Fast evaporating cutting fluid for flat, soft-coated, automotive and mirrored glass
- For 2 to 15mm thick glass and mirror
- Residue free finish
- Recommended for low-e

| CAT. NO. | CONTENTS | 1 |
|-----------|-----------|---------|
| EUW9531L | 1 Litre | £7.45 |
| EUW9535L | 5 Litres | £26.50 |
| EUW95325L | 25 Litres | £112.75 |

*Minimum order: 1 each. Price based on an order quantity of 1 (CAT. NO. EUW9531L).

FROM ONLY
£7.45*





CRL ROUND EDGE TEMPLATE GUIDE

- Make consistent radius corners easier than ever
- Choose from 12 radii (10mm to 70mm)
- Solid plastic construction makes it economical and unbreakable
- Features four slip-resistant pads to keep the template in place during use and to reduce the risk of scratching the glass

ONLY
£11.50*



| CAT. NO. | DESCRIPTION | 1 |
|----------|---------------------------|--------|
| RET12 | Round Edge Template Guide | £11.50 |

*Minimum order: 1 each. Price based on an order quantity of 1.

CRL L-SQUARE

- Sturdy, durable and accurate
- Made to exacting specifications to ensure a right angle time after time
- Upright Thickness: 4mm
- Upright Width: 65mm

FROM ONLY
£22.70*



| CAT. NO. | DESCRIPTION | 1 | 10 |
|----------|-----------------|--------|--------|
| M00555 | 1100mm L-Square | £27.20 | £25.25 |
| M00556 | 1310mm L-Square | £27.40 | £22.70 |
| M00557 | 1560mm L-Square | £38.30 | £35.60 |

*Minimum order: 1 each. Price based on an order quantity of 10 (CAT. NO. M00556).

CRL DROP JAW GLASS BREAKING PLIERS

- Excellent forged steel pliers for glass up to 12mm thick
- One of the most popular glass tools
- Drop jaw design for superior leverage
- 216mm overall length

FROM ONLY
£14.55*



| CAT. NO. | DESCRIPTION | 1 | 5 |
|----------|-----------------------------|--------|--------|
| RD1932 | Drop Jaw Glass Break Pliers | £15.25 | £14.55 |

*Minimum order: 1 each. Price based on an order quantity of 5.

CRL FLARED JAW GLASS PLIERS

- 25.4mm flared jaw
- Smooth grip
- 210mm overall length
- Precision machined tips

FROM ONLY
£14.55*

BEST SELLER



| CAT. NO. | DESCRIPTION | 1 | 5 |
|----------|-------------------------|--------|--------|
| RD1935 | Flared Jaw Glass Pliers | £15.25 | £14.55 |

*Minimum order: 1 each. Price based on an order quantity of 5.



CRL CUT RESISTANT LEVEL 5 WRIST GUARDS

- Our best value wrist guard
- Ambidextrous - can be worn on either arm
- Velcro fastening
- Durable and comfortable
- BS EN 388 X-5-X-3
- Sold by the pair

| CAT. NO. | LENGTH | 1 | 12 | 24 |
|----------|--------|--------|--------|--------|
| 0601 | 152 mm | £12.40 | £10.80 | £10.20 |
| 06012 | 203 mm | £13.85 | £12.00 | £11.40 |

*Minimum order: 1 pair. Price based on an order quantity of 24 pairs (CAT. NO. 0601).
Price includes 10% discount. Special discount available from 1st September to 31st December 2016.

FROM ONLY
£10.20*
PER PAIR

BSEN388 RATED

GREAT VALUE



SAVE
10%

CRL CUT-RESISTANT POWERFLEX+ KEVLAR® GLOVES

- Excellent cut resistance and grip
- Protects against cuts, punctures, and slashes
- Cut Level 5
- Tested EN388 3444
- Sold by the pair

| CAT. NO. | SIZE | 1 | 20 |
|----------|--------|--------|-------|
| 0625 | Small | £10.20 | £9.05 |
| 0626 | Medium | £10.20 | £9.05 |
| 0627 | Large | £10.20 | £9.05 |

*Minimum order: 1 pair. Price based on an order quantity of 20 pairs (CAT. NO. 0625).
Price includes 10% discount. Special discount available from 1st September to 31st December 2016.

FROM ONLY
£9.05*
PER PAIR

BSEN388 RATED



SAVE
10%

CRL CUT-RESISTANT KEVLAR® GLOVES

- Cut Level 5
- Tested EN388 4544
- Sold by the Pair
- Come in three sizes

| CAT. NO. | SIZE | 1 | 20 |
|----------|--------|-------|-------|
| 0625A | Small | £7.75 | £6.25 |
| 0626A | Medium | £7.75 | £6.25 |
| 0627A | Large | £7.75 | £6.25 |

*Minimum order: 1 pair. Price based on an order quantity of 20 pairs (CAT. NO. 0625A).
Price includes 10% discount. Special discount available from 1st September to 31st December 2016.

FROM ONLY
£6.25*
PER PAIR

BSEN388 RATED



SAVE
10%

CRL ATLAS® CUT-RESISTANT KEVLAR® GLOVES

- Ergonomic fit as well as an outstanding grip
- The perfect glove for glass fabricators
- ANSI cut resistance: 3
- Comes in four sizes

| CAT. NO. | SIZE | 1 |
|----------|-------------|-------|
| 300KVS | Small | £6.80 |
| 300KVM | Medium | £6.80 |
| 300KVL | Large | £6.80 |
| 300KVXL | Extra Large | £6.80 |

*Minimum order: 1 pair. Price based on an order quantity of 1 pair (CAT. NO. 300KVS).
Price includes 10% discount. Special discount available from 1st September to 31st December 2016.

ONLY
£6.80*
PER PAIR

SAVE
10%



CRL TAPE MEASURES

- Accurate measurements in centimeters
- Professional quality
- Positive lock button

| CAT. NO. | LENGTH | WIDTH | 1 | 6 | 10 |
|----------|--------|-------|--------|-------|--------|
| 0427S | 5m | 19mm | £15.50 | - | £12.70 |
| 54819 | 5m | 19mm | £7.25 | £6.65 | - |
| SBM5 | 5m | 32mm | £17.15 | - | - |

*Minimum order: 1 each. Price based on an order quantity of 6 (CAT. NO. 130583)

FROM ONLY
£6.65*



CAT. NO. 0427S



CAT. NO. SBM5



CAT. NO. 54819

CRL GLASS GAUGE PRO

- Measures single and double glazed units
- Easy read double-sided rule with 2mm graduations
- Designed to fit around UPVC windows and doors
- Reflection device shows the thickness of each individual pane
- Specially designed ball-tip for maximum accuracy
- Manufactured from engineering grade plastic

| CAT. NO. | DESCRIPTION | 1 | 6 |
|----------|-----------------|--------|--------|
| 0471B | Glass Gauge Pro | £34.95 | £32.50 |

*Minimum order: 1 each. Price based on an order quantity of 6.

FROM ONLY
£32.50*



CRL METRIC SCALE GLASS THICKNESS LASER

- Measures from inside of the building - no glass removal is necessary
- Calculates the thicknesses of insulating glass, laminated, bullet-resistant, and single lite float glass
- Padded carrying case and batteries included
- Provides metric measurements

| CAT. NO. | DESCRIPTION | 1 |
|----------|------------------------------|---------|
| MG1500MM | Glass Thickness Metric Laser | £231.50 |

ONLY
£231.50



CRL GLASS-CHEK ELITE

- Identifies laminated glass in a window
- Measures the thickness of the laminate inner-layer
- Graphical display shows profile of window
- Can identify piece of glass with Low-e coating

| CAT. NO. | DESCRIPTION | 1 | 4 |
|----------|------------------|---------|---------|
| GC3200 | Glass-Chek Elite | £983.75 | £940.25 |

*Minimum order quantity: 1 each. Price based on an order quantity of 4.

FROM ONLY
£940.25*





CRL MAKITA® 29MM X 533MM BELT SANDER 240V

- Extremely popular portable sander for sanding notches and cut-outs
- Side handle for easy manoeuvrability • Compact and lightweight

| CAT. NO. | DESCRIPTION | 1 |
|----------|-------------|---------|
| EU9031M | Belt Sander | £240.80 |

*Minimum order: 1 each. Price based on an order quantity of 1. Price includes 5% discount. Special discount available from 1st September to 31st December 2016.

ONLY
£240.80*

SAVE
5%

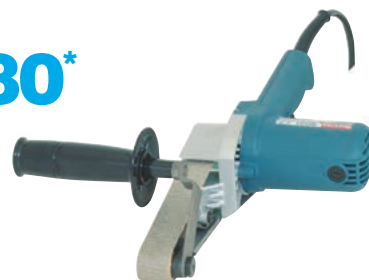

CRL 29MM X 533MM GLASS GRINDING BELTS FOR PORTABLE SANDERS

- Designed for use with the CRL EU9031M sander
- 29 x 533 mm
- Fast grinding 100% polyester backed belts for notches and cut-outs
- Belts in 12 grits from 40X to CORK
- Sold by the box

| CAT. NO. | DESCRIPTION | QTY/BOX | 1 | 5 | 10 | 20 |
|---------------|----------------|---------|-------|-------|-------|------|
| CRL118X2140X | 40 Grit | 10 | 6.60 | 5.85 | 5.25 | 4.95 |
| CRL118X2160X | 60 Grit | 10 | 6.05 | 5.25 | 4.85 | 4.50 |
| CRL118X2180X | 80 Grit | 10 | 5.75 | 5.05 | 4.65 | 4.35 |
| CRL118X21120X | 120 Grit | 10 | 5.65 | 4.95 | 4.50 | 4.20 |
| CRL118X21180X | 180 Grit | 10 | 5.65 | 4.95 | 4.50 | 4.20 |
| CRL118X21220X | 220 Grit | 10 | 5.65 | 4.95 | 4.50 | 4.20 |
| CRL118X21400X | 400 Grit | 10 | 5.65 | 4.95 | 4.50 | 4.20 |
| CRL118X21CORK | Cork Polishing | 5 | 12.35 | 11.25 | 10.35 | 9.55 |

*Minimum order: 1 box. Price based on an order quantity of 20 boxes (CAT. NO. CRL118X21120X). Price includes 15% discount. Special discount available from 1st September to 31st December 2016.

FROM ONLY
£4.20*
PER BOX

SAVE
15%



CRL 100MM X 1830MM ABRASIVE BELTS FOR BOHLE BELT MACHINES

- Top quality, long lasting • Polyester wet-dry backing
- Non-directional • Sold individually

| CAT. NO. | DESCRIPTION | 1 | 20 |
|----------|----------------|--------|-------|
| 13317K | 60 Grit | £9.15 | £6.35 |
| 1317BK | 80 Grit | £6.65 | £4.80 |
| 1317DK | 100 Grit | £6.65 | £4.80 |
| 1317B05K | 120 Grit | £6.65 | £4.80 |
| 13320K | 150 Grit | £8.25 | £5.75 |
| 1317B1K | 180 Grit | £6.65 | £4.80 |
| 1317B3K | 220 Grit | £6.65 | £4.80 |
| 1317B2K | 400 Grit | £6.65 | £4.80 |
| 1317EK | Cork Polishing | £12.65 | £8.85 |

*Minimum order: 1 each. Price based on an order quantity of 20 (CAT. NO. 1317BK). Price includes 10% discount. Special discount available from 1st September to 31st December 2016.

FROM ONLY
£4.80*
PER BELT

SAVE
10%

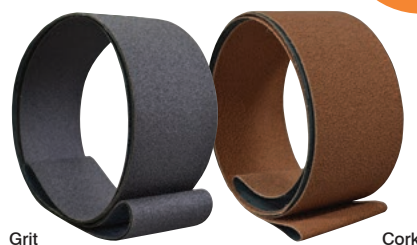

Grit

Cork

CRL 100MM X 1800MM ABRASIVE BELTS FOR GLASMEK BELT MACHINE

- Top quality, long lasting • Polyester wet-dry backing
- Non-directional • Sold individually

| CAT. NO. | DESCRIPTION | 1 | 20 |
|----------|----------------|--------|--------|
| 13309K | 60 Grit | £9.00 | £6.30 |
| 13310K | 80 Grit | £8.40 | £5.90 |
| 1327K | 120 Grit | £5.50 | £4.35 |
| 13143K | 180 Grit | £8.05 | £5.65 |
| 1317HK | 220 Grit | £7.40 | £5.15 |
| 1317AK | Cork Polishing | £12.65 | £10.10 |

*Minimum order: 1 each. Price based on an order quantity of 20 (CAT. NO. 1327K). Price includes 10% discount. Special discount available from 1st September to 31st December 2016.

FROM ONLY
£4.35*
PER BELT

SAVE
10%

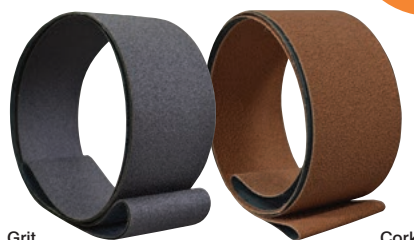

Grit

Cork





CRL DIAMOND HAND PADS

- Long-lasting diamond abrasive
- Works great on smooth or uneven surfaces
- Use wet or dry
- 57mm x 95mm pad size

| CAT. NO. | COLOUR | GRIT | 1 |
|----------|-------------------|-------------------|--------|
| DHP60 | Green | 60X | £13.85 |
| DHP120 | Black | 120X | £11.90 |
| DHP220 | Red | 220X | £9.25 |
| DHP400 | Yellow | 400X | £8.70 |
| DHPSET | Set of above pads | Set of above pads | £40.55 |

*Minimum order: 1 each. Price based on an order quantity of 1 (CAT. NO. DHP400).

FROM ONLY
£8.70*



BEST SELLER

CRL MAKITA® CORDLESS DIAMOND SAW 10.8V

- Complete with battery, battery charger, diamond saw blade and water feed bottle
- Recommended replacement blade: CAT. NO. NS3B

| CAT. NO. | DESCRIPTION | 1 |
|----------|----------------------|---------|
| 15605 | Cordless diamond saw | £219.85 |

*Minimum order: 1 each. Price based on an order quantity of 1.

ONLY
£219.85*



CRL METAL BOND DIAMOND GLASS CUTTING BLADE

- Produces a clean, chip-free cut in glass and mirror
- Perfect choice for cutting notches and straight lines
- Suitable for use with CAT. NO. 15605 Diamond Saw
- 86mm diameter

| CAT. NO. | DESCRIPTION | 1 |
|----------|--|--------|
| NS3B | Metal bond diamond glass cutting blade | £26.50 |

*Minimum order: 1 each. Price based on an order quantity of 1.

ONLY
£26.50*



CRL HEAVY-DUTY SCRATCH POLISHER

- Polishes all types of glass, from windshields to watch crystals
- Use it hand-held or bench mounted for added stability
- Powered by a heavy-duty, double-insulated motor
- Sure grip handles on each end of the tool assembly provide control
- Includes felt wheel (CAT. NO. 1322) and 1kg of Cerium Oxide (CAT.NO. 1222A)

| CAT. NO. | DESCRIPTION | 1 |
|----------|-----------------------|---------|
| 1520 | 230V Scratch Polisher | £615.00 |
| 1520A | 110V Scratch Polisher | £615.00 |

*Minimum order: 1 each. Price based on an order quantity of 1 (CAT. NO. 1520). Price includes 10% discount. Special discount available from 1st September to 31st December 2016.

ONLY
£615.00*

**SAVE
10%**





CRL S338 SURE-GRIP 203MM VACUUM LIFTER

- Greatest lifting capacity of any 203mm pump activated vacuum lifter
- One hand pump and attachment for safety when needed
- Superior “press-and-pump” attachment feature
- Built-in vacuum loss indicator
- Soft contoured sure-grip handle for comfort
- Sturdy moulded carrying case

FROM ONLY
£28.05*

| CAT. NO. | DESCRIPTION | 1 | 4 | 10 |
|----------|---------------|--------|--------|--------|
| S338 | Vacuum Lifter | £29.95 | £29.05 | £28.05 |

*Minimum order: 1 each. Price based on an order quantity of 10.



**112KG
LIFTING
CAPACITY**

Safety factor 2:1

CONVENIENT
VACUUM
INDICATOR



SUPERIOR
COMFORT
AND GRIP



FAST
RELEASE





CRL PUMP-ACTION VACUUM LIFTER FOR CURVED GLASS

- 203mm diameter pad
- Designed primarily for lifting curved architectural glass
- Excellent also for thin, flexible materials
- Red-line indicator warns user of any vacuum loss
- Moulded carrying case
- 56kg lifting capacity

FROM ONLY **£31.60***



| CAT. NO. | DESCRIPTION | 1 | 4 | 10 |
|-------------|---------------------------|--------|--------|--------|
| S109 | Pump-Action Vacuum Lifter | £35.70 | £33.65 | £31.60 |

*Minimum order: 1 each. Price based on an order quantity of 10.

CRL PUMP-ACTION VACUUM LIFTER FOR FLAT SURFACES

- 203mm diameter pad
- Heavy-duty stainless steel handle
- Fast attachment on smooth, non-porous flat surfaces
- Can be re-pumped without losing remaining vacuum
- Tough ABS plunger with red-line indicator
- Full pad face contact when pumped reduces distortion
- Wide release valve lever with safety guard permits quick and complete release
- 57kg lifting capacity

FROM ONLY **£40.30***



| CAT. NO. | DESCRIPTION | 1 | 4 |
|--------------|---------------------------------|--------|--------|
| S7950 | 203mm Pump-Action Vacuum Lifter | £44.45 | £40.30 |

*Minimum order: 1 each. Price based on an order quantity of 4.

CRL PUMP-ACTION VACUUM LIFTER

- 203mm diameter pad
- Heavy-duty 5mm thick ABS handle resists bending, especially during heavy lifts
- Fast, safe attachment to smooth, non-porous flat surfaces
- Four extra mounting points make it easy to attach to metal lifting frames, jigs, and our vacuum ratchet tensioning kit
- 56kg lifting capacity

FROM ONLY **£28.05***



| CAT. NO. | DESCRIPTION | 1 | 4 | 10 |
|-------------|---------------------------|--------|--------|--------|
| S108 | Pump-Action Vacuum Lifter | £30.10 | £29.10 | £28.05 |

*Minimum order: 1 each. Price based on an order quantity of 10.

CRL ALUMINIUM FRAME VACUUM LIFTERS

- Sturdily built traditional design aluminium frame
- Each suction pad operates separately
- 114mm diameter suction pads

SAVE 10%

FROM ONLY **£23.40***



| CAT. NO. | DESCRIPTION | LIFTING CAPACITY | 1 | 6 |
|--------------|---------------|------------------|--------|--------|
| 05061 | 1 Vacuum Pad | 30kg | £26.30 | £23.40 |
| 05062 | 2 Vacuum Pads | 60kg | £29.95 | £26.55 |
| 05063 | 3 Vacuum Pads | 100kg | £36.05 | £30.55 |

*Minimum order: 1 each. Price based on an order quantity of 6 (CAT. NO. 05061). Price includes 10% discount. Special discount available from 1st September to 31st December 2016.



CRL WOOD'S POWR-GRIP® ABS HANDLE VACUUM CUP

- 203mm diameter pad
- Lightweight, heavy-duty ABS handle
- Check valve allows re-pumping without loss of remaining vacuum
- Release valve lever permits quick and complete release
- Fast attachment on smooth, non-porous flat surfaces
- Red-line indicator warns user of any vacuum loss
- Supplied with protective carrying case

FROM ONLY
£28.05*



Wood's
Powr-Grip

CE

| CAT. NO. | DESCRIPTION | 1 | 4 | 10 |
|--------------|-----------------------|--------|--------|--------|
| N4000 | ABS Handle Vacuum Cup | £29.95 | £29.05 | £28.05 |

*Minimum order: 1 each. Price based on an order quantity of 10.

CRL WOOD'S POWR-GRIP® METAL HANDLE VACUUM CUP

- 203mm diameter pad
- Durable metal handle
- Check valve allows re-pumping without loss of remaining vacuum
- Fast attachment on smooth, non-porous flat surfaces
- Red-line indicator warns user of any vacuum loss
- Release valve lever permits quick, complete release

FROM ONLY
£51.50*



Wood's
Powr-Grip

CE

| CAT. NO. | DESCRIPTION | 1 | 4 | 10 |
|--------------|-------------------------|--------|--------|--------|
| N4950 | Metal Handle Vacuum Cup | £56.00 | £53.80 | £51.50 |

*Minimum order: 1 each. Price based on an order quantity of 10.
Price includes 10% discount. Special discount available from 1st September to 31st December 2016.

CRL WOOD'S POWR-GRIP® SINGLE CHANNEL D.C. VACUUM LIFTING FRAME

- 320kg lifting capacity
- Four 280mm diameter lipped pads
- 180° edgewise rotation
- 90° tilt, vertical to flat
- 12V DC

Get specifications online at crlaurence.co.uk

ONLY
£2179.00*



Wood's
Powr-Grip

CE

| CAT. NO. | DESCRIPTION | 1 |
|--------------------|--|----------|
| EUP11104DCO | Single Channel D.C. Vacuum Lifting Frame | £2179.00 |

*Minimum order: 1 each. Price based on an order quantity of 1.
Price includes 10% discount. Special discount available from 1st September to 31st December 2016.

CRL WOOD'S POWR-GRIP® D.C. TILT ROTATOR VACUUM LIFTING FRAMES

- Cord-free operation with on-board gel cell battery
- 280mm diameter lipped pads
- Multiple configurations all from the same unit
- Full 360° rotation with tilt from any position
- 12V DC

Get specifications online at crlaurence.co.uk

FROM ONLY
£2959.00*



Wood's
Powr-Grip

CE

| CAT. NO. | DESCRIPTION | 1 |
|----------------------|---|----------|
| EUMRT411LDC | D.C. Manual Rotator/Tilter - 4 pads | £2959.00 |
| EUMRTA811LDC2 | D.C. Quadra Tilt Rotator 1100 Series - 8 pads | £4149.00 |

*Minimum order: 1 each. Price based on an order quantity of 1 (CAT. NO. EUMRT411LDC).
Price includes 10% discount. Special discount available from 1st September to 31st December 2016.



Ask about our annual service for lifting frames





CRL RATCHET TENSIONING KIT WITH TWO VACUUM LIFTERS

- Pulls with tremendous force
- Ideal for countertops, marble, granite, flooring, mirrors and glass
- Comes with two 203mm vacuum lifters
- Uses S108 vacuum lifter mounting points
- Carrying capacity is 147kg

ONLY **£110.45***



NOTE: S108 vacuum lifters are sold separately on page 13.

| CAT. NO. | DESCRIPTION | 1 |
|----------|------------------------|---------|
| G0284 | Ratchet Tensioning Kit | £110.45 |

*Minimum order: 1 each. Price based on an order quantity of 1.

CRL GLASSTRAX GLASS DOLLY

- Safe glass transport with large 272kg capacity
- Self clamping action locks loads up to 50.8mm thick
- One person can load and manoeuvre

SAVE **10%**

FROM ONLY **£285.75***

BEST SELLER



VIEW A DEMO

| CAT. NO. | DESCRIPTION | 1 | 4 |
|----------|-------------|---------|---------|
| GT02 | Glass Dolly | £330.00 | £285.75 |

*Minimum order: 1 each. Price based on an order quantity of 4. Price includes 10% discount. Special discount available from 1st September to 31st December 2016.

CRL ALL TERRAIN DOLLY

- Exclusive to CRL
- Terrific for moving heavy glass panels around the job site
- Goes where other glass dollies won't
- Built-In 203mm Wood's Powr-Grip® Vacuum Cup
- Includes a set of our RB200 Roller Blocks
- 181kg load capacity

ONLY **£423.00***



Included

| CAT. NO. | DESCRIPTION | 1 |
|----------|-------------------|---------|
| ATD1 | All Terrain Dolly | £423.00 |

*Minimum order: 1 each. Price based on an order quantity of 1.

CRL ROLLER BLOCKS

- Roller design lets you rotate heavy glass panels with ease
- Turn them over to use as resting blocks
- Rubber base ensures traction

ONLY **£39.00***
PER PAIR



| CAT. NO. | DESCRIPTION | 1 |
|----------|---------------|--------|
| RB200 | Roller Blocks | £39.00 |

*Minimum order: 1 pair. Price based on an order quantity of 1 pair.



CRL NEUTRAL CURE LOW MODULUS SILICONE

- Low odour, neutral cure formula
- Compatible with insulating glass glazing
- Excellent adhesion to most surfaces
- Low modulus
- High grade formula - low shrinkage
- 300ml cartridge, 12 per case
- Special countertop display box
- Conforms to ISO 11600

| CAT. NO. | COLOUR | 1 | 12 | 120 | 240 | |
|------------|------------|-------|-------|-------|-------|-------|
| EURTV408C | Clear | £1.99 | £1.79 | £1.74 | £1.69 | |
| EURTV408W | White | £1.99 | £1.79 | £1.74 | £1.69 | |
| EURTV408BL | Black | £1.99 | £1.79 | £1.74 | £1.69 | |
| EURTV408G | Grey | £1.99 | £1.79 | £1.74 | £1.69 | |
| EURTV408BR | Brown | £1.99 | £1.79 | £1.74 | £1.69 | |
| EURTV408A | Anthracite | NEW! | £1.99 | £1.79 | £1.74 | £1.69 |
| EURTV408R | Rosewood | NEW! | £1.99 | £1.79 | £1.74 | £1.69 |

*Minimum order: 1 each. Price based on an order quantity of 240 (CAT. NO. EURTV408C).



FROM ONLY
£1.69*

BEST SELLER

THE PROFESSIONALS' CHOICE

NOW AVAILABLE IN 7 COLOURS



CRL CRYSTAL CLEAR SILICONE

- High clarity when cured
- Applications include shower enclosures and speciality glass assemblies
- 310ml cartridge
- 12 per case
- Special countertop display box

| CAT. NO. | COLOUR | 1 | 12 | 120 | 240 |
|----------|---------------|-------|-------|-------|-------|
| EUCCS | Crystal Clear | £2.07 | £1.95 | £1.89 | £1.85 |

*Minimum order: 1 each. Price based on an order quantity of 240. Price includes 10% discount. Special discount available from 1st September to 31st December 2016.

FROM ONLY
£1.85*

SAVE 10%



CRL SHOWER SEALANT

- Acetic cure formula
- Plastic cartridges with screw-on nozzles
- High modulus
- 300ml cartridge
- 12 per case
- Special countertop display box

| CAT. NO. | COLOUR | 1 | 12 | 120 | 240 |
|----------|--------|-------|-------|-------|-------|
| EU33SC | Clear | £1.55 | £1.35 | £1.30 | £1.25 |

*Minimum order: 1 each. Price based on an order quantity of 240. Price includes 10% discount. Special discount available from 1st September to 31st December 2016.

FROM ONLY
£1.25*

SAVE 10%



CRL COATED GLASS SEALANTS

- High quality, professional and universal paintable sealant
- Used for the sealing of connecting joints and glazing systems
- Conforms with Pilkington Activ and Saint Gobain Bio Clean
- Resistant to weather, UV, water, and fungus
- 290 ml cartridge
- 12 per case

| CAT. NO. | COLOUR | 1 | 12 | 120 | 240 |
|----------|--------|-------|-------|-------|-------|
| EUCGSBL | Black | £4.10 | £3.85 | £3.75 | £3.65 |
| EUCGSBR | Brown | £4.10 | £3.85 | £3.75 | £3.65 |
| EUCGSG | Grey | £4.10 | £3.85 | £3.75 | £3.65 |
| EUCGSW | White | £4.10 | £3.85 | £3.75 | £3.65 |

*Minimum order: 1 each. Price based on an order quantity of 240 (CAT. NO. EUCGSBL). Price includes 10% discount. Special discount available from 1st September to 31st December 2016.

FROM ONLY
£3.65*

SAVE 10%



THE PROFESSIONALS' CHOICE





CRL STANDARD SMOOTH ROD CAULKING GUN

- Our best seller is also a great value
- Thumb pressure release button
- Perfect for low viscosity materials

**MORE
OPTIONS
AVAILABLE
ONLINE**

FROM ONLY
£2.30*



| CAT. NO. | DESCRIPTION | 1 | 12 |
|----------|----------------------------------|-------|-------|
| ER3 | Standard Smooth Rod Caulking Gun | £2.55 | £2.30 |

*Minimum order: 1 each. Price based on an order quantity of 12.

CRL 12:1 RATIO STRAP FRAME CAULKING GUN

- Holds standard caulking cartridges
- Best choice for low to medium viscosity materials
- Instant pressure release to prevent run-on

**MORE
OPTIONS
AVAILABLE
ONLINE**

FROM ONLY
£12.15*



| CAT. NO. | DESCRIPTION | 1 | 12 |
|----------|-------------------------------------|--------|--------|
| GA1203 | 12:1 Ratio Strap Frame Caulking Gun | £13.20 | £12.15 |

*Minimum order: 1 each. Price based on an order quantity of 12.

CRL E.Z.D. GLAZER DE-GLAZING TOOL

- Aids in the de-glazing of glass installed with silicone, foam tapes, butyl tapes, and other flexible materials
- Blade lays flat on the glass and slides into the glazing pocket
- Extremely simple-to-use

FROM ONLY
£37.75*



CAT. NO. EZ1022
Replacement blade

| CAT. NO. | DESCRIPTION | 1 | 6 |
|----------|-------------------------------|--------|--------|
| EZ1010 | E.Z.D. Glazer De-Glazing Tool | £40.75 | £37.75 |
| EZ1022 | Replacement Blade | £18.35 | - |

*Minimum order: 1 each. Price based on an order quantity of 6 (CAT. NO. EZ1010).

CRL PUTTY KNIVES

- Large soft-grip handle
- High carbon steel blade
- Several blade widths to choose from
- Economically priced

FROM ONLY
£3.15*



| CAT. NO. | DESCRIPTION | WIDTH | 1 | 12 |
|----------|-------------|-------|-------|-------|
| HW033 | Flexible | 38mm | £3.50 | £3.15 |
| HW034 | Flexible | 51mm | £3.70 | £3.35 |
| HW035 | Flexible | 76mm | £4.30 | £3.85 |
| HW036 | Flexible | 102mm | £4.70 | £4.20 |
| HW039 | Stiff | 76mm | £4.30 | £3.85 |

*Minimum order: 1 each. Price based on an order quantity of 12 (CAT. NO. HW033).



CRL SCRAPE 'N' PRY BAR

- Multi-purpose tool made of hardened, tempered steel
- Chisel ground edges
- Length: 254mm
- Width: 44.5mm

FROM ONLY
£4.89*



| CAT. NO. | DESCRIPTION | 1 | 6 |
|----------|--------------------|-------|-------|
| 4050 | Scrape 'N' Pry Bar | £5.29 | £4.89 |

*Minimum order: 1 each. Price based on an order quantity of 6.

CRL 8-IN-1 PAINTER'S TOOL

- Multi purpose tool
- Comfort grip handle
- Overall length: 232mm
- Blade width: 76mm

FROM ONLY
£3.50*



| CAT. NO. | DESCRIPTION | 1 | 6 |
|----------|-----------------------|-------|-------|
| HW048 | 8-in-1 Painter's Tool | £4.70 | £3.50 |

*Minimum order: 1 each. Price based on an order quantity of 6.

CRL PUTTY KNIFE CHISEL

- Overall length: 210mm
- Blade width: 38mm
- Made from high-grade carbon steel for strength and longevity

FROM ONLY
£7.75*



| CAT. NO. | DESCRIPTION | 1 | 12 |
|----------|--------------------|-------|-------|
| 0704 | Putty Knife Chisel | £9.05 | £7.75 |

*Minimum order: 1 each. Price based on an order quantity of 12.

CRL STIFF PUTTY KNIFE

- High quality putty knife
- Blade length: 110mm
- Width: 26mm

ONLY
£10.75*



| CAT. NO. | DESCRIPTION | 1 |
|----------|-------------------|--------|
| 0702 | Stiff Putty Knife | £10.75 |

*Minimum order: 1 each. Price based on an order quantity of 1.





CRL OLFA® HEAVY-DUTY RETRACTABLE BLADE KNIFE

- All-Purpose knife with comfortable rubber grip
- Locking thumb screw to adjust blade length
- Uses replacement blades LB10B, LB50B, and LS0L

FROM ONLY
£5.55*



| CAT. NO. | DESCRIPTION | 1 | 6 |
|----------|------------------------------------|-------|-------|
| L2K | Heavy-Duty Retractable Blade Knife | £6.00 | £5.55 |

*Minimum order: 1 each. Price based on an order quantity of 6.

CRL REPLACEMENT BREAKAWAY BLADES

- Fits CRL Olfa® heavy-duty retractable blade knife L2K
- Width: 18mm
- 50 per pack

FROM ONLY
£8.15*
PER PACK

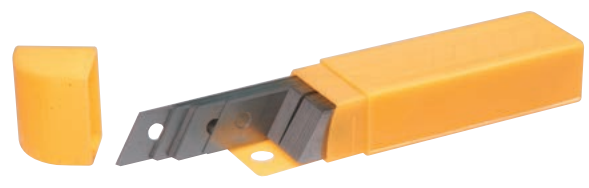

| CAT. NO. | DESCRIPTION | 1 | 6 |
|----------|------------------------------|-------|-------|
| LB50B | Replacement Breakaway Blades | £8.60 | £8.15 |

*Minimum order: 1 pack. Price based on an order quantity of 6 packs.

CRL STANLEY® HEAVY-DUTY RETRACTABLE BLADE UTILITY KNIFE

- Industrial quality
- Retractable blade
- Features a five-position slide and heavy-duty metal body

FROM ONLY
£4.70*



| CAT. NO. | DESCRIPTION | 1 | 6 |
|----------|------------------------------------|-------|-------|
| 99 | Heavy-Duty Retractable Blade Knife | £5.05 | £4.70 |

*Minimum order: 1 each. Price based on an order quantity of 6.

CRL STANLEY® TYPE UTILITY KNIFE BLADES

- Fits CRL Stanley® heavy-duty retractable blade knife 99
- 100 per pack

ONLY
£4.50*
PER PACK

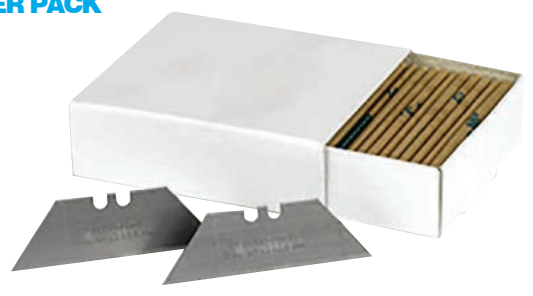

| CAT. NO. | DESCRIPTION | 1 | 20 |
|----------|---------------------------------|-------|-------|
| 14171 | Heavy-duty Utility Knife Blades | £5.50 | £4.50 |

*Minimum order: 1 box. Price based on an order quantity of 1 box.



CRL RAZOR BLADE HOLDER AND SCRAPER

- Safely holds single edge metal razor blades
- Comfortable handle for a sure grip
- Compatible with 51S and KKB12 razor blades

ONLY
£5.05*



BEST SELLER

| CAT. NO. | DESCRIPTION | 1 |
|----------|--------------------------------|-------|
| RS65 | Razor Blade Holder and Scraper | £5.05 |

*Minimum order: 1 each. Price based on an order quantity of 1.

CRL SINGLE EDGE RAZOR BLADES

- Our most popular single edge blade
- Precision honed, surgical steel edges
- Individually wrapped to protect the edge
- Multiple uses
- 100 per box

FROM ONLY
£2.50*
PER HUNDRED



PRICES PER BOX OF 100 BLADES

| CAT. NO. | DESCRIPTION | 100 | 500 | 1000 | 5000 | 10000 |
|----------|--------------------------|-------|-------|-------|-------|-------|
| 51S | Single Edge Razor Blades | £3.15 | £3.00 | £2.80 | £2.65 | £2.50 |
| KKB12 | Heavy-Duty Razor Blades | £3.75 | £3.45 | £3.35 | £3.25 | - |

*Minimum order: 100 each. Price based on an order quantity of 10,000 (CAT. NO. 51S).

CRL RAZOR BLADE HOLDER AND WINDOW SCRAPER

- Safely holds all single edge metal razor blades
- Simple thumb slide to safely conceal blade when not in use
- Compatible with our CAT. NO.'s 51S and 1409 single edge razor blades

FROM ONLY
£1.05*

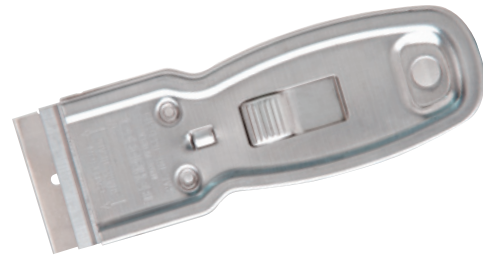

| CAT. NO. | DESCRIPTION | 1 | 12 | 36 |
|----------|---------------------------------------|-------|-------|-------|
| 3223 | Razor Blade Holder and Window Scraper | £1.30 | £1.15 | £1.05 |

*Minimum order: 1 each. Price based on an order quantity of 36.

CRL SINGLE EDGE RAZOR BLADES

- Deliver durability along with an exact quality cut
- Each blade is individually wrapped to protect the edge until you are ready to use
- 100 per box
- Compatible with our CAT. NO. 3223 holder and scraper

FROM ONLY
£4.55*
PER HUNDRED



PRICES PER BOX OF 100 BLADES

| CAT. NO. | DESCRIPTION | 100 | 500 | 1000 | 5000 | 10000 |
|----------|--------------------------|-------|-------|-------|-------|-------|
| 1409 | Single Edge Razor Blades | £5.55 | £5.35 | £5.05 | £4.80 | £4.55 |

*Minimum order: 100 each. Price based on an order quantity of 10,000.



CRL PUSH POINTS

- Our most popular push points
- Packages in convenient display boxes for over-the-counter sales
- Available in bulk container or retail display

| CAT. NO. | DESCRIPTION | 1 | 5 | 10 |
|----------|-------------------------------|-------|-------|-------|
| 30 | Retail display of 12 packages | £9.50 | £8.65 | £7.95 |
| 31B | 0.45kg bulk container | £6.30 | £5.70 | £5.25 |

*Minimum order: 1 each. Price based on an order quantity of 10 (CAT. NO. 31B).

FROM ONLY
£5.25*



CRL LIGHTWEIGHT GLAZIER'S HAMMER

- Ideal for glazing and picture framing
- 295mm laquered ashwood handle
- Forged steel hardened and fully polished head with stabilizing supports
- Overall Length: 310mm

| CAT. NO. | DESCRIPTION | 1 | 5 |
|----------|------------------|--------|--------|
| 0220 | Glazier's Hammer | £16.85 | £15.15 |

*Minimum order: 1 each. Price based on an order quantity of 5.

FROM ONLY
£15.15*



CRL PLATE GLASS LIFTING TOOL

- For lifting and setting plate glass
- Helps prevent lifting related injuries
- Aids in storefront window installation
- Width: 273mm

| CAT. NO. | DESCRIPTION | 1 |
|----------|--------------------------|-------|
| PGL11 | Plate Glass Lifting Tool | £5.55 |

*Minimum order: 1 each. Price based on an order quantity of 1.

ONLY
£5.55*

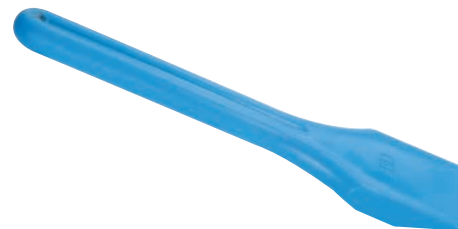

CRL BLOCK LEVERS

- Handy tool for all glazing jobs
- Choose either the all wood or the strong wooden handle with hard-wearing plastic head block lever

| CAT. NO. | DESCRIPTION | 1 | 10 |
|----------|--------------------------|-------|-------|
| 0735 | Plastic Head Block Lever | £3.25 | £2.55 |
| 0736 | All Wood Block Lever | £1.45 | £1.35 |

*Minimum order: 1 each. Price based on an order quantity of 10 (CAT. NO. 0736).

FROM ONLY
£1.35*





CRL STANDARD VINYL ROLLER TOOL

- Ideal for inserting all types of flat spline and roll-in gaskets
- Made from solid aluminium with a hard coat anodised finish
- Knurl diamond grip and a ball bearing wheel

| CAT. NO. | LENGTH | 1 | 6 |
|----------|--------|-------|-------|
| VR04 | 279mm | £7.25 | £6.60 |

*Minimum order: 1 each. Price based on an order quantity of 6.

FROM ONLY
£6.60*



CRL PLASTIC GLAZING BLOCKS

- Colour coded for easy selection by size
- Polypropylene material is extremely durable
- 1000 of one size per box

| CAT. NO. | SIZE | COLOUR | 1 | 3 | 5 |
|----------|----------------|--------|--------|--------|--------|
| KK201 | 100 x 20 x 1mm | White | £25.75 | £23.75 | £22.05 |
| KK202 | 100 x 20 x 2mm | Blue | £27.70 | £25.60 | £23.75 |
| KK203 | 100 x 20 x 3mm | Red | £29.25 | £27.00 | £25.10 |
| KK204 | 100 x 20 x 4mm | Yellow | £30.55 | £28.20 | £26.20 |
| KK221 | 100 x 22 x 1mm | White | £28.30 | £26.10 | £24.25 |
| KK222 | 100 x 22 x 2mm | Blue | £29.55 | £27.30 | £25.35 |
| KK223 | 100 x 22 x 3mm | Red | £30.80 | £28.45 | £26.45 |
| KK224 | 100 x 22 x 4mm | Yellow | £32.95 | £30.40 | £28.25 |
| KK241 | 100 x 24 x 1mm | White | £31.10 | £28.70 | £26.65 |
| KK242 | 100 x 24 x 2mm | Blue | £31.65 | £29.25 | £27.15 |
| KK243 | 100 x 24 x 3mm | Red | £32.95 | £30.40 | £28.25 |
| KK244 | 100 x 24 x 4mm | Yellow | £34.50 | £31.85 | £29.55 |

*Minimum order quantity: 1 box. Price based on an order quantity of 1 box (CAT. NO. KK201).

FROM ONLY
£22.05*
PER BOX OF 1,000



CRL WOOD GLAZING BLOCKS

- Colour coded for easy selection by size
- Multi-purpose glazing blocks made of impregnated wood
- 100 per package

| CAT. NO. | SIZE | COLOUR | 1 |
|----------|---------------|--------|-------|
| KH202 | 80 x 20 x 2mm | Red | £1.80 |
| KH203 | 80 x 20 x 3mm | Green | £1.95 |
| KH204 | 80 x 20 x 4mm | Yellow | £2.35 |
| KH205 | 80 x 20 x 5mm | Blue | £2.70 |
| KH206 | 80 x 20 x 6mm | Black | £2.95 |

*Minimum order quantity: 1 pack. Price based on an order quantity of 1 pack (CAT. NO. KH202).

FROM ONLY
£1.80*
PER PACK OF 100

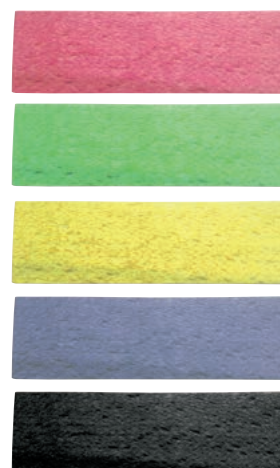



CRL BLUE TRANSPORT PADS

- Medium density
- Low-tack, pressure sensitive adhesive
- Leaves no adhesive residue or ghosting marks

SAVE
10%

| CAT. NO. | SIZE | QUANTITY | 1 | 5 |
|-----------|---------------|----------------------|--------|--------|
| 1407E | 23 x 18 x 4mm | 1,000 pads per roll | £5.05 | £4.75 |
| 1407LOG10 | 24 x 19 x 4mm | 10,000 pads per roll | £52.70 | £40.55 |
| 1407LOG20 | 21 x 18 x 4mm | 20,000 pads per roll | £85.05 | £80.10 |

*Minimum order quantity: 1 roll. Price based on an order quantity of 5 rolls (CAT. NO. 1407E)
Price includes 10% discount. Special discount available from 1st September to 31st December 2016.

FROM ONLY
£4.75*
PER ROLL

BEST SELLER

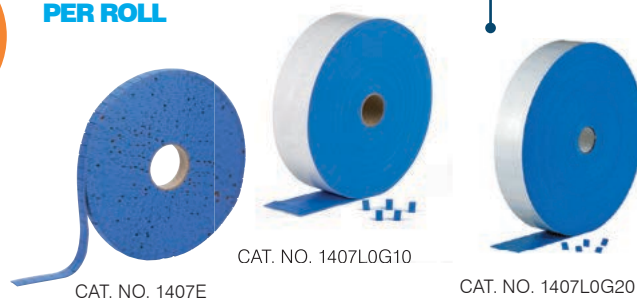

CRL CLEAR PROTECTIVE BUMPADS

- Use on cabinet doors, desk tops, and glass table tops
- Also available in brown and white
- Protect glass tops from scratching
- Simply peel and stick
- Bottom diameter 12.7mm; top diameter: 11.1mm; height: 3.2mm

| CAT. NO. | QUANTITY | 1 | 3 |
|----------|---------------|--------|--------|
| CB1PK200 | 200 per pack | £7.70 | - |
| CB1PK | 1000 per pack | £33.65 | £30.35 |

*Minimum order: 1 pack. Price based on an order quantity of 1 pack (CAT. NO. CB1PK200).

FROM ONLY
£7.70*
PER PACK

MULTI-USAGE



CRL VITROBOR SURFACE PROTECTION FILM

- 40 micron green film
- Adhesive free
- No residue
- Static hold
- Prevents scratches
- Tested to BS2782

| CAT. NO. | ROLL SIZE | 1 | 10 |
|----------|---------------|---------|---------|
| 21112G | 600mm x 920m | £88.50 | £78.70 |
| 21113G | 1000mm x 920m | £147.55 | £131.15 |
| 21114G | 1200mm x 920m | £177.05 | £157.40 |
| 21115G | 1500mm x 920m | £221.30 | £196.75 |
| 21120G | 1800mm x 920m | £267.35 | £238.25 |
| 21121G | 2100mm x 920m | £294.40 | £261.75 |

*Minimum order quantity: 1 roll. Price based on an order quantity of 10 rolls (CAT. NO. 21112G)
Price includes 10% discount. Special discount available from 1st September to 31st December 2016.

FROM ONLY
£78.70*
PER ROLL

SAVE
10%



CRL CORNER PROTECTORS

- Designed to protect glass and mirror edges during shipping, handling or storing
- Will not scratch or damage glass or mirror surfaces, and help protect large cut-offs from breakage or becoming scrap
- Protectors are reusable, they simply slide on and off
- 250 per box

| CAT.NO. | GLASS THICKNESS | 1 |
|----------|-----------------|--------|
| 1464004B | 4mm | £18.00 |
| 1464006B | 6mm | £16.35 |
| 1464008B | 8mm | £18.95 |
| 1464010B | 10mm | £21.15 |

*Minimum order: 1 box. Price based on an order quantity of 1 box (CAT. NO. 1464006B).

FROM ONLY
£16.35*
PER BOX





CREATE THE PERFECT BATHROOM

CRL, the world's largest supplier of
frameless shower products



See the full range

Get your Shower Door
Hardware brochure today
CAT. NO. SDH17UK





CRL eg310 evergrip™ MIRROR ADHESIVE

- Extra fast grab mirror adhesive
- Extra strong holding capacity
- Fast curing, with skin formation in about five minutes
- Adhesion to almost all surfaces
- Low VOC, solvent free, low odour
- 310ml cartridge

FROM ONLY **£1.85***

BEST SELLER

SAVE 10%



| CAT. NO. | DESCRIPTION | 12 | 60 | 120 | 240 |
|--------------|-----------------|-------|-------|-------|-------|
| EG310 | Mirror Adhesive | £2.15 | £2.00 | £1.95 | £1.85 |

*Minimum order: 12 each. Price based on an order quantity of 240 each. Price includes 10% discount. Special discount available from 1st September to 31st December 2016.

CRL eg310ULTRA COMPLETE ADHESIVE

- MS polymer based
- Neutral curing and odourless
- Cures with atmospheric moisture
- Super-fast bonding of mirrors, glass, wood, composite panels, and metal, to a range of substrates
- Free of silicone and isocyanides
- 290ml cartridge

FROM ONLY **£3.90***

HIGH PERFORMANCE GRIP AND GRAB ADHESIVE

SAVE 10%

MULTI PURPOSE ADHESIVE



| CAT. NO. | DESCRIPTION | 12 | 60 | 120 | 240 |
|-------------------|-------------------|-------|-------|-------|-------|
| EG310ULTRA | Complete Adhesive | £4.55 | £4.25 | £4.10 | £3.90 |

*Minimum order: 12 each. Price based on an order quantity of 240 each. Price includes 10% discount. Special discount available from 1st September to 31st December 2016.

CRL E-Z MOUNT MIRROR CLIP SET

- Our best-selling mirror clip sets are the fast and secure way to hang mirrors
- For 4mm and 6mm glass
- Made of nickel plated steel
- Upper clips - have unique, spring loaded flanges. You just expand these clips during installation, it's quick and easy!
- Lower clips - always remain stationary and have a 7.9mm channel space. These clips are not spring-loaded, and are designed to carry the mirror's weight

FROM ONLY **£1.17***



| CAT. NO. | DESCRIPTION | 1 | 3 | 5 | 10 | 20 | 50 | 100 | 250 | 1000 |
|---------------|-------------------|-------|-------|-------|-------|-------|-------|-------|-------|-------|
| 655 | Set of 4 Clips | 1.58 | - | - | - | - | £1.48 | £1.38 | £1.28 | £1.17 |
| 50655B | Bulk carton of 50 | 57.00 | 53.00 | 50.50 | 47.70 | 44.25 | - | - | - | - |

*Minimum order: 1 set. Price based on an order quantity of 1000 sets (CAT. NO. 655).

CRL HEATED MIRROR PADS

- Prevents mirror misting
- Simple installation
- Applied to back of mirror
- Made in Europe
- 240 Volts

FROM ONLY **£14.90***

HIGH PERFORMANCE

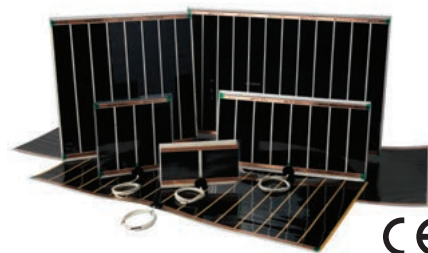

| CAT. NO. | SIZE | 1 | 10 | 100 |
|---------------|----------------|--------|--------|--------|
| 7020MP | 584mm x 274mm | £18.65 | £16.00 | £14.90 |
| 7030MP | 524mm x 520mm | £26.30 | £22.60 | £21.00 |
| 7035MP | 785mm x 524mm | £32.60 | £27.90 | £26.00 |
| 7040MP | 1040mm x 524mm | £39.65 | £34.00 | £31.75 |
| 7050MP | 1505mm x 524mm | £57.80 | £49.60 | £46.35 |

*Minimum order: 1 each. Price based on an order quantity of 100 (CAT. NO. 7020MP).



CRL EM SERIES MIRROR MOUNTING SET

- Magnet mirror mounting set including eccentric discs, mirror-adhesive magnets, mirror plates, self-adhesive pads, screws, and wall plugs
- Easy installation
- Fixings hidden from sight
- Suitable for mirror surfaces up to 0.8m², 1.6m², and 2.6m²
- Suitable for wet rooms

Each set includes: P19EM08/P19EM16: 2 each eccentric discs, 2 each mirror-adhesive magnets, 2 each mirror plates. P19EM26: 3 each eccentric discs, 2 each mirror-adhesive magnets, 3 each mirror plates.

| CAT. NO. | DESCRIPTION | 1 | 24 | 48 |
|----------------|----------------------------------|-------|-------|-------|
| P19EM08 | 0.8m ² Mirror Surface | £3.40 | £3.15 | £2.90 |
| P19EM16 | 1.6m ² Mirror Surface | £4.05 | £3.75 | £3.50 |
| P19EM26 | 2.6m ² Mirror Surface | £5.10 | £4.70 | £4.35 |

*Minimum order: 1 set. Price based on an order quantity of 48 sets (CAT. NO. P19EM08).

FROM ONLY
£2.90*
PER SET

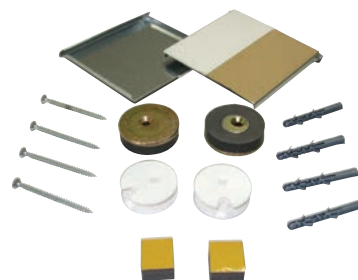

CRL DEEP NOSE ALUMINIUM J-BAR FOR MIRROR

- Punched and slotted for easier installation
- 3.66m stock lengths
- 40 per case

| CAT. NO. | FINISH | 1 | 10 | 40 | 80 | 120 |
|---------------|----------------|--------|--------|--------|--------|--------|
| D645BA | Brite Anodised | £15.35 | £13.65 | £12.30 | £11.15 | £10.15 |
| D645A | Satin Anodised | £10.15 | £9.05 | £8.15 | £7.40 | £6.80 |
| D645BN | Brushed Nickel | £21.95 | £19.60 | £17.65 | £16.00 | £14.70 |

*Minimum order: 1 each. Price based on an order quantity of 120 (CAT. NO. D645A).

FROM ONLY
£6.80*
PER LENGTH

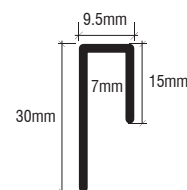

CRL STANDARD ALUMINIUM J-BAR FOR MIRROR

- Punched and slotted for easier installation
- 3.66m stock lengths
- 50 per case

| CAT. NO. | FINISH | 1 | 10 | 50 | 100 | 150 |
|---------------|----------------|--------|--------|--------|--------|--------|
| D636BA | Brite Anodised | £13.25 | £11.75 | £10.60 | £9.60 | £8.90 |
| D636A | Satin Anodised | £8.70 | £7.70 | £7.00 | £6.35 | £5.90 |
| D636BN | Brushed Nickel | £18.35 | £16.30 | £14.70 | £13.35 | £12.20 |

*Minimum order: 1 each. Price based on an order quantity of 150 (CAT. NO. D636A).

FROM ONLY
£5.90*
PER LENGTH

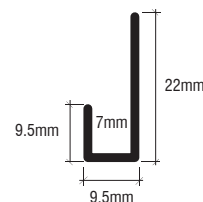
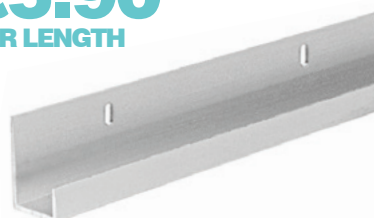

CRL ALL-PURPOSE FOAM MOUNTING TAPE

- Highly adhesive and flexible
- Conforms to a wide variety of surfaces
- Just peel and apply
- Excellent for mirrors, glass, metals, plastics and other surfaces
- Ideal for use in combination with mirror adhesive

| CAT. NO. | LENGTH | WIDTH | THICKNESS | ROLLS / CASE | 1 | 16 | 23 | 80 | 115 |
|------------------|--------|-------|-----------|--------------|-------|-------|-------|-------|-------|
| CRL211612 | 33m | 12.5m | 1.6mm | 23 | £5.60 | - | £4.95 | - | £4.75 |
| CRL211634 | 33m | 19m | 1.6mm | 16 | £7.10 | £6.40 | - | £6.10 | - |
| CRL210812 | 15m | 12.5m | 3mm | 23 | £3.75 | - | £3.35 | - | £3.25 |
| CRL210834 | 15m | 19m | 3mm | 16 | £5.10 | £4.60 | - | £4.45 | - |

*Minimum order: 1 roll. Price based on an order quantity of 5 cases (CAT. NO. CRL210812).

FROM ONLY
£3.25*
PER ROLL





CRL TRANSPARENT ACRYLIC HI-BOND ADHESIVE TAPE

- Speciality tape for the fabrication of shower enclosures
- Excellent for use with clear polycarbonates, seals, and wipes
- Instant pressure sensitive bonding; full strength in 72 hours

FROM ONLY
£5.65*
PER ROLL



| CAT. NO. | THICKNESS | WIDTH | LENGTH | ROLLS / CASE | 1 | 36 |
|-----------|-----------|--------|--------|--------------|-------|-------|
| AT0201436 | 0.5 mm | 6.3 mm | 11 m | 36 | £6.15 | £5.65 |
| AT0401436 | 1 mm | 6.3 mm | 11 m | 36 | £6.60 | £6.05 |

*Minimum order: 1 roll. Price based on an order quantity of 36 rolls (CAT. NO. AT0201436).

CRL ROUND MIRROR CLIP SET

- 19mm diameter clips for use with 6mm mirror
- Supplied with No. 8 X 32mm flat head wood screws and plastic anchors
- 4 clips per set

FROM ONLY
£5.80*
PER SET



| CAT. NO. | FINISH | 1 | 12 | 24 |
|----------|----------------|-------|-------|-------|
| MC02CH | Chrome | £7.10 | £6.40 | £5.80 |
| MC02BN | Brushed Nickel | £7.10 | £6.40 | £5.80 |

*Minimum order: 1 set. Price based on an order quantity of 24 sets (CAT. NO. MC02CH).

CRL ALUMINIUM TAPE WITH LINER

- Protects the back of the mirror against moisture ingress
- 600mm x 45m

FROM ONLY
£23.95*
PER ROLL



SAVE
10%

| CAT. NO. | DESCRIPTION | 1 | 10 | 25 |
|----------|-----------------------------------|--------|--------|--------|
| 2108600 | Aluminium Tape with Liner | £32.95 | £26.95 | £23.95 |
| 2108600A | Premium Aluminium Tape with Liner | £59.15 | £45.45 | £36.15 |

*Minimum order: 1 roll. Price based on an order quantity of 25 rolls (CAT. NO. 2108600). Price includes 10% discount. Special discount available from 1st September to 31st December 2016.

CRL MIRABAC POLYPROPYLENE MIRROR BACKING

- Keeps glass fragments together should mirror accidentally break
- accidentally break thus reducing the chance of personal injury
- Ready to use and easy-to-apply
- Tested to BS EN 12600
- 60 Micron

FROM ONLY
£8.15*
PER ROLL

GREAT VALUE

SAVE
10%



| CAT. NO. | WIDTH | LENGTH | 1 | 10 | 20 |
|----------|--------|--------|---------|---------|---------|
| 21051A | 200mm | 100m | £15.75 | £12.00 | £8.15 |
| 21051 | 300mm | 100m | £23.55 | £17.95 | £12.20 |
| 21052 | 450mm | 100m | £34.95 | £26.60 | £18.05 |
| 21053 | 604mm | 100m | £47.25 | £35.95 | £24.40 |
| 21056A | 770mm | 250m | £147.15 | £112.15 | £76.00 |
| 21058B | 650mm | 250m | £126.65 | £96.55 | £65.45 |
| 21058A | 914mm | 250m | £175.55 | £133.85 | £90.65 |
| 21060A | 1220mm | 250m | £237.65 | £181.05 | £122.65 |

*Minimum order: 1 roll. Price based on an order quantity of 20 rolls (CAT. NO. 21051A). Price includes 10% discount. Special discount available from 1st September to 31st December 2016.



CRL Chrome Deluxe Shower Squeegee

CAT. NO. 17600

£13.25



CRL GLASS AND MIRROR CLEANER

- A long time favourite of the glass industry
- Ammoniated formula with a pleasant aroma
- Twelve big 660ml cans per case

FROM ONLY
£1.70*
PER CAN

OWN LABEL
VERSION AVAILABLE



SAVE
10%

| CAT. NO. | CONTENTS | 12 | 60 | 144 |
|----------|-----------|-------|-------|-------|
| EB1701 | 660ml can | £2.15 | £1.90 | £1.70 |

*Minimum order: 12 cans. Price based on an order quantity of 144 cans.
Price includes 10% discount. Special discount available from 1st September to 31st December 2016.

CRL MICRO FIBRE WIPES

- Streak free cleaning on windows and mirrors
- Washable up to 500 times
- 406mm x 406mm size
- Packed two per poly bag with a hanger hook so you can also offer them for resale to your customers

FROM ONLY
£3.15*
PER PACK



| CAT. NO. | DESCRIPTION | 1 | 5 | 10 |
|----------|-------------------|-------|-------|-------|
| MFW2 | Micro Fibre Wipes | £3.55 | £3.30 | £3.15 |

*Minimum order: 1 pack. Price based on an order quantity of 10.

CRL TPC SURFACE PROTECTOR

- Transparent polymer coating
- Water, soil, and stain repellent
- Protects glass and many other surfaces
- Clear coating guards against the adhesion and build-up of dirt, grime, mould, mildew, rust and mineral deposits
- Suitable for clear and sandblasted glass surfaces

FROM ONLY
£5.75*



| CAT. NO. | CONTENTS | 1 | 12 |
|----------|-----------------|---------|-------|
| TPC16 | 475ml bottle | £6.25 | £5.75 |
| TPC5GL | 18.93 litre tub | £178.50 | - |

*Minimum order: 1 bottle. Price based on an order quantity of 12 bottles (CAT. NO. TPC16).
NOTE: Will call trade counter pick-up only for TPC5GL.

CRL INVISIBLE SHIELD GLASS SURFACE SEALER

- Seals, polishes and protects glass
- Keeps surfaces like new
- Prevents build up of soap scum and hard water stains
- Suitable for clear and sandblasted glass surfaces

FROM ONLY
£19.45*



To pre-clean the glass before applying the sealer, please order CAT. NO. 17230

| CAT. NO. | SIZE | 1 | 10 |
|----------|---------|--------|--------|
| 17200 | 1 Litre | £22.95 | £19.45 |

*Minimum order: 1 each. Price based on an order quantity of 10





CRL 6K HYDROPHOBIC SURFACE PROTECTION SYSTEM FOR GLASS AND STAINLESS STEEL

FROM ONLY **£4.75***

STAGE ONE
PRE-CLEAN

- Stage one - Pre-clean
- Thoroughly cleans glass or stainless steel ready for the protection stage
- Ideal for shower screens and glass railings
- Dries streak-free
- Conforms to EN 45001



OWN LABEL
VERSION AVAILABLE

| CAT. NO. | SIZE | 1 | 6 |
|----------|---------|--------|--------|
| PC6010 | 100ml | £5.80 | £4.75 |
| PC6025 | 250ml | £10.70 | £8.90 |
| PC6050 | 500ml | £14.95 | £12.40 |
| PC6100 | 1 Litre | £22.55 | £18.90 |

*Minimum order: 1 bottle. Price based on an order quantity of 6 bottles (CAT. NO. PC6010).

CRL 6K HYDROPHOBIC SURFACE PROTECTION SYSTEM FOR GLASS AND STAINLESS STEEL

FROM ONLY **£13.95***

STAGE TWO
PROTECT

- Stage two - Protect
- 3 year protection lifespan
- Protects glass or stainless steel
- Ideal for shower screens and glass railings
- Nano-technology
- Long lasting - wide coverage
- Conforms to EN 45001



OWN LABEL
VERSION AVAILABLE

| CAT. NO. | SIZE | 1 | 6 |
|----------|---------|---------|--------|
| 6K6010 | 100ml | £15.70 | £13.95 |
| 6K6025 | 250ml | £31.10 | £26.00 |
| 6K6050 | 500ml | £55.90 | £46.55 |
| 6K6100 | 1 Litre | £104.45 | £87.25 |

*Minimum order: 1 bottle. Price based on an order quantity of 6 bottles (CAT. NO. 6K6010).

CRL 6K HYDROPHOBIC SURFACE PROTECTION SYSTEM CLOTHS

FROM ONLY **£1.12***

- To be used with CRL6K Pre-clean and Protect products



| CAT. NO. | COLOUR | FOR USE WITH | 1 | 10 | 50 |
|----------|--------|--------------|-------|-------|-------|
| PCCLOTH | Red | Pre-clean | £1.33 | £1.22 | £1.12 |
| 6KCLOTH | Blue | Protect | £1.33 | £1.22 | £1.12 |

*Minimum order: 1 each. Price based on an order quantity of 50 (CAT. NO. PCCLOTH).

CRL AFTERCARE GLASS CLEANER

FROM ONLY **£4.60***

- Non-silicone based glass cleaner
- Leaves glass clear and smear-free
- Ideal for shower screens



RECOMMENDED
FOR USE WITH 6K

| CAT. NO. | CONTENTS | 1 | 6 |
|----------|----------|-------|-------|
| AC6050 | 500ml | £5.50 | £4.60 |

*Minimum order: 1 bottle. Price based on an order quantity of 6 bottles.



CRL ALUMINIUM U-CHANNEL FOR 6 TO 8MM GLASS

- Available in 2.49m lengths
- Wet glaze with clear silicone
- Extremely versatile extrusion in up to 5 popular finishes - see crlaurence.co.uk

FROM ONLY
£5.85*
PER LENGTH

**SAVE
10%**

| CAT. NO. | FINISH | 1 | 10 | 40 | 80 | 120 |
|------------------|----------------|-------|-------|-------|-------|-------|
| SDCD516BA | Brite Anodised | £8.50 | £7.65 | £6.90 | £6.40 | £5.85 |
| SDCD516BN | Brushed Nickel | £8.75 | £7.85 | £7.15 | £6.55 | £6.05 |

*Minimum order: 1 each. Price based on an order quantity of 120 (CAT. NO. SDCD516BA).
Price includes 10% discount. Special discount available from 1st September to 31st December 2016.

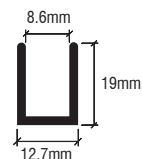

CRL ALUMINIUM U-CHANNEL FOR 10MM GLASS

- Wet glazed with clear silicone to secure glass
- Available in 2.49m and 3.65m stock lengths
- Available in up to 17 finishes - see crlaurence.co.uk

**SAVE
10%**

FROM ONLY
£6.15*
PER LENGTH

| CAT. NO. | FINISH | LENGTH | DEPTH | 1 | 10 | 40 | 50 | 80 | 100 | 120 | 150 |
|-------------------|----------------|--------|-------|--------|--------|--------|--------|--------|-------|-------|-------|
| SDCD38BA | Brite Anodised | 2.49m | 19mm | £8.95 | £8.05 | £7.35 | - | £6.65 | - | £6.15 | - |
| SDCD38BN | Brushed Nickel | 2.49m | 19mm | £9.25 | £8.25 | £7.55 | - | £6.85 | - | £6.35 | - |
| SDCD3812BA | Brite Anodised | 3.65m | 19mm | £13.10 | £11.75 | £10.70 | - | £9.85 | - | £9.05 | - |
| SDCD3812BN | Brushed Nickel | 3.65m | 19mm | £13.55 | £12.20 | £11.05 | - | £10.15 | - | £9.35 | - |
| SDCR38BA | Brite Anodised | 2.49m | 9.5mm | £9.95 | £8.85 | - | £7.95 | - | £7.25 | - | £6.65 |
| SDCR38BN | Brushed Nickel | 2.49m | 9.5mm | £13.15 | £11.75 | - | £10.55 | - | £9.55 | - | £8.75 |

*Minimum order: 1 each. Price based on an order quantity of 120 (CAT. NO. SDCD38BA).
Price includes 10% discount. Special discount available from 1st September to 31st December 2016.

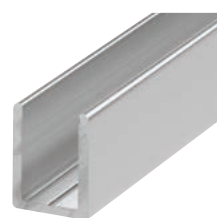

CAT. NO. SDCD38

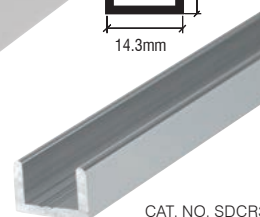
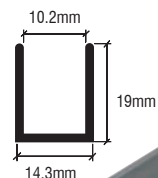

CAT. NO. SDCR38

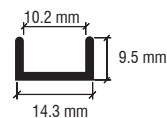

CRL ALUMINIUM U-CHANNEL FOR 10 TO 12MM GLASS

- Wet glaze with clear silicone to secure glass
- Available in three finishes
- 2mm wall thickness
- Sold per 3 metre length

FROM ONLY
£8.65*
PER LENGTH

**SAVE
10%**

| CAT. NO. | FINISH | SIZE | 1 | 10 | 20 |
|-------------------|----------------|--------------------|--------|--------|--------|
| SDCD1515A | Satin Anodised | 15mm x 15mm x 15mm | £11.25 | £9.45 | £8.65 |
| SDCD1515CH | Chrome Plated | 15mm x 15mm x 15mm | £36.05 | £30.05 | £27.75 |
| SDCD1515BN | Brushed Nickel | 15mm x 15mm x 15mm | £24.10 | £20.10 | £18.55 |
| SDCD2020A | Satin Anodised | 20mm x 20mm x 20mm | £12.65 | £10.55 | £9.75 |
| SDCD2020CH | Chrome Plated | 20mm x 20mm x 20mm | £45.15 | £37.65 | £34.75 |
| SDCD2020BN | Brushed Nickel | 20mm x 20mm x 20mm | £28.85 | £24.05 | £22.25 |
| SDCD3020A | Satin Anodised | 30mm x 20mm x 30mm | £17.25 | £14.40 | £13.25 |
| SDCD3020CH | Chrome Plated | 30mm x 20mm x 30mm | £75.35 | £62.75 | £57.95 |
| SDCD3020BN | Brushed Nickel | 30mm x 20mm x 30mm | £38.85 | £32.35 | £29.85 |
| SDCD4020A | Satin Anodised | 40mm x 20mm x 40mm | £24.00 | £20.00 | £18.45 |
| SDCD4020CH | Chrome Plated | 40mm x 20mm x 40mm | £73.25 | £61.05 | £56.35 |
| SDCD4020BN | Brushed Nickel | 40mm x 20mm x 40mm | £54.20 | £45.15 | £41.75 |

*Minimum order: 1 each. Price based on an order quantity of 20 (CAT. NO. SDCD1515A).
Price includes 10% discount. Special discount available from 1st September to 31st December 2016.

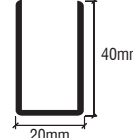
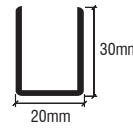
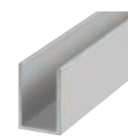
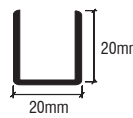
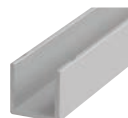
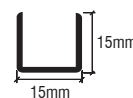
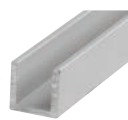

AVAILABLE IN A LARGE RANGE OF STANDARD FINISHES





CRL ALUMINIUM U-CHANNEL FOR 12 MM GLASS

FROM ONLY **£6.50*** PER LENGTH

- Wet glazed with clear silicone to secure fixed panels of glass
- Lower profile allows maximum glass exposure

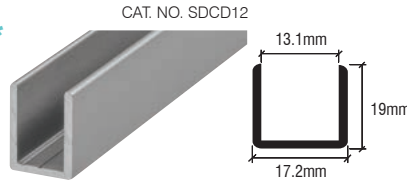

| CAT. NO. | FINISH | LENGTH | DEPTH | 1 | 10 | 40 | 50 | 80 | 100 | 120 | 150 |
|-------------|----------------|--------|-------|--------|--------|--------|--------|--------|-------|-------|-------|
| SDCCD1212BA | Brite Anodised | 3.65m | 19mm | £13.85 | £12.45 | £11.35 | - | £10.45 | - | £9.55 | - |
| SDCCD1212BN | Brushed Nickel | 3.65m | 19mm | £14.35 | £12.90 | £11.70 | - | £10.75 | - | £9.90 | - |
| SDCCD12BA | Brite Anodised | 2.49m | 19mm | £9.40 | £8.50 | £7.70 | - | £7.05 | - | £6.50 | - |
| SDCCD12BN | Brushed Nickel | 2.49m | 19mm | £9.75 | £8.75 | £7.95 | - | £7.30 | - | £6.75 | - |
| SDCR12BA | Brite Anodised | 2.49m | 9.5mm | £10.35 | £9.15 | - | £8.25 | - | £7.50 | - | £6.85 |
| SDCR12BN | Brushed Nickel | 2.49m | 9.5mm | £13.55 | £11.95 | - | £10.85 | - | £9.85 | - | £9.05 |

*Minimum order: 1 each. Price based on an order quantity of 120 (CAT. NO. SDCCD12BA). Price includes 10% discount. Special discount available from 1st September to 31st December 2016.



CRL DRY GLAZE U-CHANNEL WITH VINYL FOR 8 AND 10MM GLASS

FROM ONLY **£11.15*** PER LENGTH

- Clear vinyls secure glass in channel and eliminate the need for messy silicone
- Recess in bottom channel hides caulk line
- DUC38 can be used with 8mm glass where RV8DUC rigid vinyl is used (available separately)
- Individually packaged
- 2.49m length

| CAT. NO. | FINISH | GLASS THICKNESS | LENGTH | 1 | 10 | 50 |
|----------|----------------|-----------------|--------|--------|--------|--------|
| DUC516BA | Brite Anodised | 8mm | 2.49m | £14.45 | £13.50 | £12.15 |
| DUC516BN | Brushed Nickel | 8mm | 2.49m | £16.45 | £14.95 | £13.75 |
| DUC38BA | Brite Anodised | 10mm | 2.49m | £13.75 | £12.35 | £11.15 |
| DUC38BN | Brushed Nickel | 10mm | 2.49m | £15.35 | £13.95 | £12.75 |

*Minimum order: 1 each. Price based on an order quantity of 50 (CAT. NO. DUC38BA). Price includes 10% discount. Special discount available from 1st September to 31st December 2016.

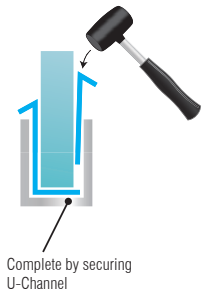
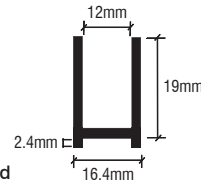
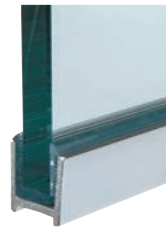

NOTE: glass is not included



CRL END CAPS FOR DEEP AND DRY GLAZE U-CHANNEL

- Covers open end of SDCCD12 and SDCCD1212 series u-channel
- Easily applied with a dab of silicone sealant
- Caps are also available for 10mm regular or dry glaze u-channel

| CAT. NO. | FINISH | FOR USE WITH | 10 | 60 |
|-----------|----------------|-----------------------|-------|-------|
| SDCEC12CH | Chrome | SDCCD12BA/SDCCD1212BA | £1.43 | £1.28 |
| SDCEC12BN | Brushed Nickel | SDCCD12BN/SDCCD1212BN | £1.43 | £1.28 |

*Minimum order: 10 each. Price based on an order quantity of 60 (CAT. NO. SDCEC12CH).

FROM ONLY **£1.28***



CRL CLEAR PLASTIC SETTING BLOCKS

- Barely visible blocks are great for use in shower installations
- 80±5 durometer hardness
- Widely used in frameless shower installations

PRICES PER 100 BLOCKS

| CAT. NO. | THICKNESS | WIDTH | LENGTH | 100 | 500 | 1000 |
|----------|-----------|-------|--------|--------|--------|--------|
| PSB040 | 1mm | 6mm | 50mm | £3.55 | £3.25 | £3.10 |
| PSB080 | 2mm | 6mm | 50mm | £3.95 | £3.70 | £3.45 |
| PSB125 | 3mm | 6mm | 50mm | £4.25 | £3.80 | £3.70 |
| PSB156 | 4mm | 6mm | 50mm | £4.95 | £4.55 | £4.35 |
| PSB250 | 6mm | 6mm | 50mm | £7.50 | £6.80 | £6.50 |
| PSB375 | 10mm | 6mm | 50mm | £12.25 | £11.25 | £10.60 |

*Minimum order: 100 blocks. Price based on an order quantity of 1000 blocks (CAT. NO. PSB040).

FROM ONLY **£3.10*** PER 100 BLOCKS

BEST SELLER



U-CHANNEL AND ACCESSORIES ARE AVAILABLE IN A LARGE RANGE OF STANDARD FINISHES



CRL CHROME GENEVA SERIES SHOWER HINGES

- Our most popular hinge series
- Self-centering with reversible 5 degree pivot pin
- For 8, 10 or 12mm monolithic toughened glass
- Adjustable hinges also available

For more details and finishes, visit crlaurence.co.uk

| CAT. NO. | MODEL | 1 | 16 |
|----------|------------------------------------|--------|--------|
| GEN037CH | Wall Mount Full Back Plate Hinge | £19.05 | £17.35 |
| GEN044CH | Wall Mount Offset Back Plate Hinge | £19.05 | £17.35 |
| GEN180CH | 180 Degree Glass-to-Glass Hinge | £25.70 | £23.35 |
| GEN092CH | 90 Degree Glass-to-Glass Hinge | £30.20 | £27.45 |

*Minimum order: 1 each. Price based on an order quantity of 16 (CAT. NO. GEN037CH).
Price includes 10% discount. Special discount available from 1st September to 31st December 2016.

FROM ONLY
£17.35*



SAVE
10%



CRL CHROME ALTEA SERIES SHOWER HINGES

- Cover plates hide fixing screws for a sleek modern design
- Solid brass hinge constructions ideal for shower environments
- Easy to install, adjust and fix

For more details, visit crlaurence.co.uk

| CAT. NO. | DESCRIPTION | 1 | 10 | 50 |
|----------|----------------------------------|--------|--------|--------|
| ALT037CH | Wall Mount Full Back Plate Hinge | £17.95 | £14.95 | £13.85 |
| ALT092CH | 90 Degree Glass-to-Glass hinge | £25.55 | £21.25 | £19.65 |
| ALT180CH | 180 Degree Glass-to-Glass Hinge | £23.30 | £19.40 | £17.90 |

*Minimum order: 1 each. Price based on an order quantity of 50 each (CAT. NO. ALT037CH).

FROM ONLY
£13.85*



CRL CHROME PINNACLE SERIES SHOWER HINGES

- Radius corners and beveled edges for an attractive, modern appeal
- Self-centering with reversible 5 degree pivot pin
- For 8, 10 or 12mm monolithic toughened glass
- Adjustable hinges also available

For more details, visit crlaurence.co.uk

| CAT. NO. | MODEL | 1 | 16 |
|----------|------------------------------------|--------|--------|
| P1N037CH | Wall Mount Full Back Plate Hinge | £20.95 | £19.00 |
| P1N044CH | Wall Mount Offset Back Plate Hinge | £20.95 | £19.00 |
| P1N180CH | 180 Degree Glass-to-Glass Hinge | £29.25 | £26.60 |
| P1N092CH | 90 Degree Glass-to-Glass Hinge | £43.00 | £39.15 |

*Minimum order: 1 each. Price based on an order quantity of 16 (CAT. NO. P1N037CH).
Price includes 10% discount. Special discount available from 1st September to 31st December 2016.

FROM ONLY
£19.00*



SAVE
10%



CRL CHROME RIVIERA SERIES PREMIUM SHOWER HINGES

- Hinges lift door when opening to avoid bottom sweep dragging
- Mounting screws concealed
- Made of solid brass
- For 8 to 10mm toughened glass

For more details, visit crlaurence.co.uk

| CAT. NO. | DESCRIPTION | 1 | 16 |
|------------|--|--------|--------|
| R1V180LNCH | 180 Degree left hand Glass-to-Glass Mount Hinge | £24.55 | £22.35 |
| R1V180RNCH | 180 Degree right hand Glass-to-Glass Mount Hinge | £24.55 | £22.35 |

*Minimum order: 1 each. Price based on an order quantity of 16 (R1V180LNCH).
Price includes 10% discount. Special discount available from 1st September to 31st December 2016.

FROM ONLY
£22.35*



SAVE
10%



AVAILABLE IN A LARGE RANGE OF STANDARD FINISHES





CRL BACK-TO-BACK EURO STYLE KNOBS

FROM ONLY
£3.45*

- Available in solid brass or plated aluminium
- For EUSKD1 series: 10mm hole required
- For EUSKD2 series: 12mm hole required
- For 6 to 12mm glass

| CAT. NO. | FINISH | SIZE | MATERIAL | 1 | 10 | 50 |
|----------|----------------|-----------|------------------|-------|-------|-------|
| EUSDK1CH | Chrome | 30 x 30mm | Solid brass | £9.15 | £8.20 | £6.45 |
| EUSDK1BN | Brushed nickel | 30 x 30mm | Solid brass | £8.70 | £7.80 | £6.20 |
| EUSDK2CH | Chrome | 30 x 30mm | Plated aluminium | £4.60 | £4.30 | £3.45 |
| EUSDK2BN | Brushed nickel | 30 x 30mm | Plated aluminium | £4.60 | £4.30 | £3.45 |

*Minimum order: 1 each. Price based on an order quantity of 50 (CAT. NO. EUSDK2CH).



CRL BACK-TO-BACK SQUARE STYLE KNOBS

FROM ONLY
£5.40*

- 28 x 28mm square knob
- Solid brass material
- Mirror quality chrome plating for the perfect finish
- For 6 to 10mm toughened glass

| CAT. NO. | FINISH | DESCRIPTION | 1 | 10 | 50 |
|-----------|--------|-------------------------------|-------|-------|-------|
| ALTSDK2CH | Chrome | Back-to-Back Shower Door Knob | £7.05 | £5.85 | £5.40 |

*Minimum order: 1 each. Price based on an order quantity of 50.



CRL BM SERIES TUBULAR BACK-TO-BACK PULL HANDLES

FROM ONLY
£11.75*

- Decorative metal washers also serve to cover any hole defects in glass
- Heavy 19mm diameter tubular construction
- Use 6 to 12mm monolithic toughened glass
- 12mm holes required

| CAT. NO. | FINISH | SIZE | MATERIAL | 1 | 10 | 50 |
|----------|----------------|-------|--------------|--------|--------|--------|
| BM6X6CH | Chrome | 152mm | Brass tubing | £14.35 | £12.95 | £11.75 |
| BM6X6BN | Brushed nickel | 152mm | Brass tubing | £14.35 | £12.95 | £11.75 |
| BM8X8CH | Chrome | 203mm | Brass tubing | £16.15 | £14.50 | £13.20 |
| BM8X8BN | Brushed nickel | 203mm | Brass tubing | £16.15 | £14.50 | £13.20 |

*Minimum order: 1 each. Price based on an order quantity of 50 (CAT. NO. BM6X6CH).



CRL SQ SERIES SQUARE TUBE BACK-TO-BACK PULL HANDLES

FROM ONLY
£22.00*

- Square corners make this handle the ideal choice to match square cornered hinges
- No metal washers allow for continuity of square profile
- Use 6 to 12mm monolithic toughened glass
- 12mm holes required

| CAT. NO. | FINISH | SIZE | MATERIAL | 1 | 10 | 50 |
|----------|----------------|-------|--------------|--------|--------|--------|
| SQ6X6CH | Chrome | 152mm | Brass tubing | £26.90 | £24.25 | £22.00 |
| SQ6X6BN | Brushed nickel | 152mm | Brass tubing | £26.90 | £24.25 | £22.00 |
| SQ8X8CH | Chrome | 203mm | Brass tubing | £29.45 | £26.55 | £24.15 |
| SQ8X8BN | Brushed nickel | 203mm | Brass tubing | £29.45 | £26.55 | £24.15 |

*Minimum order: 1 each. Price based on an order quantity of 50 (CAT. NO. SQ6X6CH).





CRL SLIMLINE SQUARE SERIES SUPPORT BARS AND BRACKETS

- Components for the fabrication of custom support bars to meet your exact needs
- Square tubing matches geometry of many popular CRL hinges
- Provides fixed panel support for enclosures not going to the ceiling
- For 6 to 8mm glass
- 15mm square tubing



CAT. NO. SQJ43CH



CAT. NO. SQJ46CH



CAT. NO. SQJ49CH



CAT. NO. SQJ41CH



CAT. NO. SQJ41DCH



CAT. NO. SQJ50CH

FROM ONLY
£3.55*



CAT. NO. SQJ39CH

**SAVE
10%**

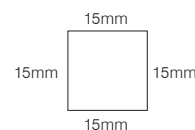

| CAT. NO. | DESCRIPTION | FINISH | 1 | 6 |
|-----------------|-----------------------------------|-----------------|--------|--------|
| SQJ39CH | 1m Slimline Square Support Bar | Polished Chrome | £23.60 | £21.25 |
| SQJ41CH | Swiveling Glass U-Bracket | Polished Chrome | £6.45 | £5.80 |
| SQJ41DCH | Swiveling Flush Mounted U-Bracket | Polished Chrome | £10.30 | £9.30 |
| SQJ43CH | Movable U-Bracket | Polished Chrome | £3.95 | £3.55 |
| SQJ46CH | Wall Mount Bracket | Polished Chrome | £4.25 | £3.85 |
| SQJ49CH | Adjustable Wall Mount Bracket | Polished Chrome | £9.35 | £8.45 |
| SQJ50CH | "T" Junction Bracket | Polished Chrome | £8.40 | £7.55 |

*Minimum order: 1 each. Price based on an order quantity of 6 (CAT. NO. SQJ43CH).
Price includes 10% discount. Special discount available from 1st September to 31st December 2016.

CRL SQUARE SERIES SUPPORT BARS AND BRACKETS

- Components for the fabrication of custom support bars to meet your exact needs
- Square tubing matches geometry of many popular CRL hinges
- Provides fixed panel support for enclosures not going to the ceiling
- For 6 to 8mm glass
- 19mm square tubing



CAT. NO. SQ45CH



CAT. NO. SQ46CH



CAT. NO. SQ41CH



CAT. NO. SQ43CH



CAT. NO. SQ59CH

**SAVE
10%**

| CAT. NO. | DESCRIPTION | FINISH | 1 | 6 |
|---------------|---------------------------|----------------|--------|--------|
| SQ59CH | 1.5m Support Bar | Chrome | £34.15 | £30.95 |
| SQ59BN | 1.5m Support Bar | Brushed nickel | £34.15 | £30.95 |
| SQ46CH | Wall Mount Bracket | Chrome | £6.05 | £5.45 |
| SQ46BN | Wall Mount Bracket | Brushed nickel | £6.05 | £5.45 |
| SQ45CH | Adjustable Corner Bracket | Chrome | £16.75 | £13.95 |
| SQ45BN | Adjustable Corner Bracket | Brushed nickel | £16.75 | £13.95 |
| SQ43CH | Movable Bracket | Chrome | £6.25 | £5.70 |
| SQ43BN | Movable Bracket | Brushed nickel | £6.25 | £5.70 |
| SQ41CH | Swiveling U-Bracket | Chrome | £10.25 | £9.35 |
| SQ41BN | Swiveling U-Bracket | Brushed nickel | £10.25 | £9.35 |

*Minimum order: 1 each. Price based on an order quantity of 6 (CAT. NO. SQ46CH).
Price includes 10% discount. Special discount available from 1st September to 31st December 2016.

FROM ONLY
£5.45*





CRL CHROME ROUND SERIES SUPPORT BARS

- For fabricating glass-to-glass or wall-to-glass support bars
- Provides fixed panel support for enclosures not going to the ceiling
- 19mm diameter straight rod
- No glass fabrication required

FROM ONLY **£11.20***



SAVE 10%

| CAT. NO. | LENGTH | FINISH | 1 | 6 |
|--------------|--------|--------|--------|--------|
| S1CH | 1m | Chrome | £12.35 | £11.20 |
| S2CH | 1.3m | Chrome | £16.00 | £14.55 |
| S80CH | 2.03m | Chrome | £31.90 | £28.90 |

*Minimum order: 1 each. Price based on an order quantity of 6 (CAT. NO. S1CH). Price includes 10% discount. Special discount available from 1st September to 31st December 2016.

CRL CHROME BRACKETS AND FITTINGS FOR ROUND SUPPORT BARS

FROM ONLY **£3.35***

- Components for the fabrication of custom support bars to meet your exact needs
- All will accept S1, S2, and S80 round support bars

| CAT. NO. | DESCRIPTION | GLASS THICKNESS | 1 | 6 |
|---------------|--------------------------|-----------------|--------|--------|
| S3CH | Wall or Ceiling Bracket | - | £6.20 | £5.60 |
| S4CH | Adjustable U-Bracket | 6mm to 8mm | £12.15 | £11.00 |
| S5CH | Adjustable U-Bracket | 10mm to 12mm | £12.15 | £11.00 |
| S6CH | Movable U-Bracket | 6mm to 8mm | £7.80 | £7.05 |
| S7CH | Movable U-Bracket | 10mm to 12mm | £8.00 | £7.30 |
| S8CH | 90° Corner Bracket | - | £6.95 | £6.25 |
| S9CH | Vertical Support Bracket | 6mm to 8mm | £6.95 | £6.25 |
| S910CH | Vertical Support Bracket | 10mm to 12mm | £6.95 | £6.25 |
| S12CH | Wall Mount Fitting | - | £3.75 | £3.35 |
| S13CH | Glass Mount Fitting | 6mm to 12mm | £7.55 | £6.85 |
| S4VCH | Shower Stabilizer | 8mm to 12mm | £8.55 | £8.00 |
| S6VCH | Shower Stabilizer | 8mm to 12mm | £8.55 | £8.00 |

*Minimum order: 1 each. Price based on an order quantity of 6 (CAT. NO. S12CH). Price includes 10% discount. Special discount available from 1st September to 31st December 2016.



SAVE 10%

CRL CHROME SUPPORT BAR COMPLETE SET OFFER

- Slim-line fittings for a streamlined profile
- Wall-to-glass hardware set for 6 to 8mm glass

ONLY **£25.50***

CAT. NO. S1CH
Support bar
Diameter: 19mm
Length: 1m

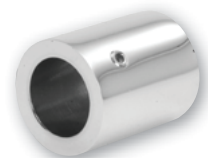

CAT. NO. S12CH
Slim Line Wall Mount Fitting



CAT. NO. S4CH
Support Bar U-Bracket

SAVE 10%

| CAT. NO. | DESCRIPTION | PRICE FOR COMPLETE SET |
|-------------------|-----------------|------------------------|
| SUP06CHSET | Support Bar Set | £25.50 |

*Minimum order: 1 each. Price based on an order quantity of 1 set. Price includes 10% discount. Special discount available from 1st September to 31st December 2016.



CRL CLEAR CO-EXTRUDED BOTTOM WIPE WITH DRIP RAIL

- Snaps on bottom of door
- 45 Degree drip rail assists in deflecting water back into the enclosure
- 2.49m stock length
- Suggested gap: 11mm

| CAT. NO. | GLASS THICKNESS | X | 1 | 10 | 40 |
|----------|-----------------|------|-------|-------|-------|
| P914WS | 6mm | 16mm | £3.90 | £3.45 | £3.15 |
| P956WS | 8mm | 16mm | £3.90 | £3.45 | £3.15 |
| P990WS | 10mm | 19mm | £5.15 | £4.55 | £4.20 |

*Minimum order: 1 each. Price based on an order quantity of 40 (CAT. NO. P914WS).

FROM ONLY
£3.15*

BEST SELLER

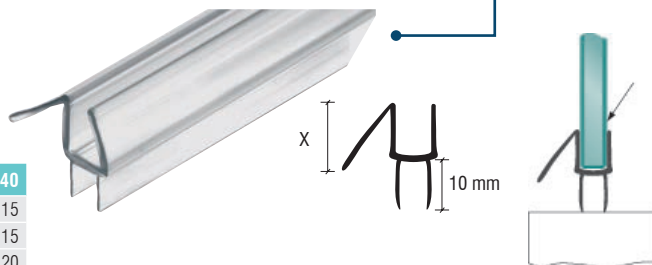

CRL CLEAR CO-EXTRUDED BOTTOM WIPE

- 45 degree drip rail assists in deflecting water back into enclosure
- Snaps on bottom of door
- For 6 to 8mm glass
- 2.49m stock lengths

| CAT. NO. | DESCRIPTION | X | 1 | 10 | 40 |
|----------|-------------------------|------|-------|-------|-------|
| P102WS | With Drip Rail | 10mm | £4.45 | £4.05 | £3.75 |
| P103WS | With Drip Rail and Bulb | 10mm | £4.45 | £4.05 | £3.75 |

*Minimum order: 1 each. Price based on an order quantity of 40 (CAT. NO. P102WS).

FROM ONLY
£3.75*

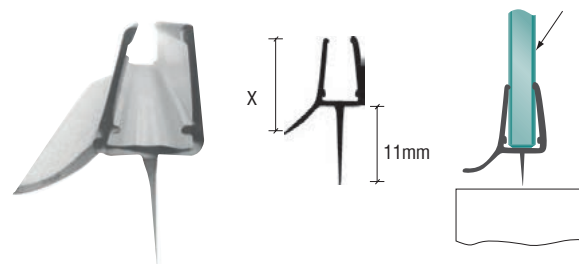

CRL CLEAR POLYCARBONATE BOTTOM RAIL WITH WIPE

- Vinyl insert included
- Snaps onto door bottom to achieve a seal
- Includes insert slot with our SDTW 'T' Wipe
- 2.49m stock length
- Suggested gap: 11mm

| CAT. NO. | GLASS THICKNESS | 1 | 10 | 40 |
|----------|-----------------|-------|-------|-------|
| P450BR | 8mm | £7.35 | £6.55 | £5.70 |

*Minimum order: 1 each. Price based on an order quantity of 40.

FROM ONLY
£5.70*

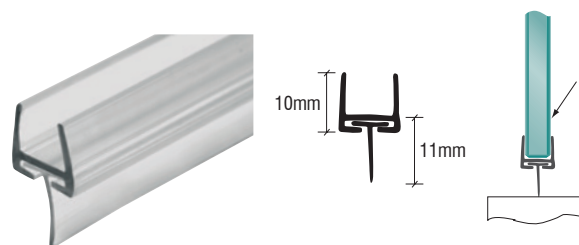

CRL CLEAR BUBBLE WIPE WITH DRIP RAIL

- Can be used on inswing and outswing doors
- Adhere flat base to glass edge or wall with CRL Very High Bond Tape, such as CAT. NO. AT0401436

| CAT. NO. | GLASS THICKNESS | 1 | 10 | 40 |
|----------|-----------------|-------|-------|-------|
| P141WS | 6mm to 8mm | £6.40 | £5.85 | £5.40 |

*Minimum order: 1 each. Price based on an order quantity of 40.

FROM ONLY
£5.40*

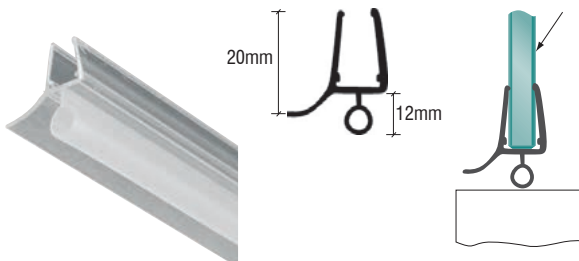



CRL CLEAR 90 DEGREE MAGNETIC PROFILE FOR GLASS-TO-GLASS

FROM ONLY **£4.45***

- Provides positive door closure
- Mix and match configurations to achieve desired result
- Made of co-extruded plastic with soft magnetic receiver
- Recommended gap between each door is 22.2mm



| CAT. NO. | GLASS THICKNESS | 1 | 10 | 40 |
|--------------|-----------------|-------|-------|-------|
| PMC8 | 6mm to 8mm | £5.25 | £4.85 | £4.45 |
| PMC10 | 10mm to 12mm | £8.15 | £7.40 | £6.90 |

*Minimum order: 1 each. Price based on an order quantity of 40 (CAT. NO. PMC8).

CRL CLEAR 45 DEGREE LH MAGNETIC PROFILE FOR GLASS-TO-GLASS

FROM ONLY **£4.45***

- Provides positive door closure
- Mix and match configurations to achieve desired result
- Made of co-extruded plastic with soft magnetic receiver
- Recommended gap between each door is 22.2mm

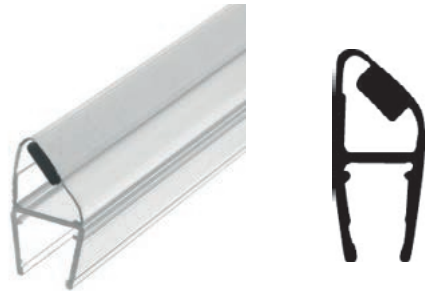

| CAT. NO. | GLASS THICKNESS | 1 | 10 | 40 |
|--------------|-----------------|-------|-------|-------|
| PMA8 | 6mm to 8mm | £5.25 | £4.85 | £4.45 |
| PMA10 | 10mm to 12mm | £8.15 | £7.40 | £6.90 |

*Minimum order: 1 each. Price based on an order quantity of 40 (CAT. NO. PMA8).

CRL CLEAR 45 DEGREE RH MAGNETIC PROFILE FOR GLASS-TO-GLASS

FROM ONLY **£4.45***

- Provides positive door closure
- Mix and match configurations to achieve desired result
- Made of co-extruded plastic with soft magnetic receiver
- Recommended gap between each door is 22.2mm

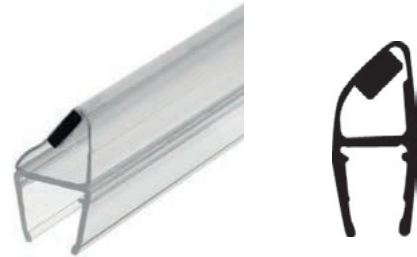

| CAT. NO. | GLASS THICKNESS | 1 | 10 | 40 |
|--------------|-----------------|-------|-------|-------|
| PMB8 | 6mm to 8mm | £5.25 | £4.85 | £4.45 |
| PMB10 | 10mm to 12mm | £8.15 | £7.40 | £6.90 |

*Minimum order: 1 each. Price based on an order quantity of 40 (CAT. NO. PMB8).

CRL CLEAR 'Y' JAMB SEAL WITH SOFT LEG

FROM ONLY **£4.25***

- Soft vinyl single leg for quieter door closure
- Snaps onto fixed panel
- For glass-to-glass applications
- Suggested gap: 4.7mm

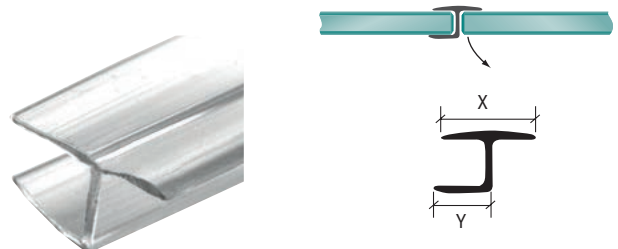

| CAT. NO. | GLASS THICKNESS | X | Y | 1 | 10 | 40 |
|--------------|-----------------|------|------|-------|-------|-------|
| PCC8 | 8mm | 19mm | 11mm | £5.05 | £4.65 | £4.25 |
| PCC10 | 10mm | 21mm | 12mm | £6.50 | £6.00 | £5.45 |

*Minimum order: 1 each. Price based on an order quantity of 40 (CAT. NO. PCC8).



CRL ADJUSTABLE SHELF BRACKET

- For glass or wood shelves 3mm to 24mm thick
- For shelves up to 254mm deep (protrusion from wall)
- Maximum recommended weight by pair is 20kg
- Includes: adjusting screw, mounting screw and foam gasket
- Material: zinc plated
- Sold in pairs

| CAT. NO. | FINISH | 1 | 12 | 60 |
|----------|----------------|-------|-------|-------|
| DL631CH | Chrome | £5.50 | £4.90 | £4.45 |
| DL631BN | Brushed Nickel | £6.25 | £5.65 | £5.10 |
| DL631W | White | £5.95 | £5.40 | £4.85 |

*Minimum order: 1 pair. Price based on an order quantity of 60 pairs (CAT. NO. DL631CH).

FROM ONLY
£4.45*
PER PAIR

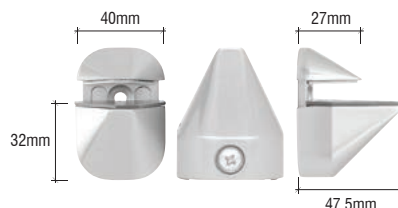

BEST SELLER



CRL INTERIOR SHOWER SHELF CLAMP

- For shelves up to 127mm deep (protrusion from wall)
- For 6mm to 10mm glass
- No glass fabrication required
- Available in three styles and up to eight finishes online at crlaurence.co.uk
- Material: solid brass

| CAT. NO. | FINISH | WIDTH | DEPTH | 1 | 10 | 50 |
|----------|----------------|--------|--------|-------|-------|-------|
| FA10CH | Chrome | 28.6mm | 25.4mm | £4.85 | £4.25 | £3.75 |
| FA10BN | Brushed Nickel | 28.6mm | 25.4mm | £4.85 | £4.25 | £3.75 |

*Minimum order: 1 each. Price based on an order quantity of 50 (CAT. NO. FA10CH).

FROM ONLY
£3.75*



NOTE: Wall anchor screws not included

CRL INTERIOR SHOWER SHELF CLAMP

- For shelves up to 127mm deep (protrusion from wall)
- For 6mm to 10mm glass
- No glass fabrication required
- Available in three styles and up to eight finishes online at crlaurence.co.uk
- Material: solid brass

| CAT. NO. | FINISH | WIDTH | DEPTH | 1 | 10 | 50 |
|----------|----------------|-------|--------|--------|-------|-------|
| FA11CH | Chrome | 100mm | 25.4mm | £10.15 | £8.95 | £7.90 |
| FA11BN | Brushed Nickel | 100mm | 25.4mm | £10.15 | £8.95 | £7.90 |

*Minimum order: 1 each. Price based on an order quantity of 50 (CAT. NO. FA11CH).

FROM ONLY
£7.90*



NOTE: Wall anchor screws not included

CRL ROUNDED INTERIOR SHOWER SHELF CLAMP

- For shelves up to 127mm deep (protrusion from wall)
- For 6mm to 10mm glass
- No glass fabrication required
- Available in three styles and up to eight finishes online at crlaurence.co.uk
- Material: solid brass

| CAT. NO. | FINISH | WIDTH | DEPTH | 1 | 10 | 50 |
|----------|----------------|--------|--------|-------|-------|-------|
| FA12CH | Chrome | 49.2mm | 25.4mm | £6.80 | £6.20 | £5.50 |
| FA12BN | Brushed Nickel | 49.2mm | 25.4mm | £6.80 | £6.20 | £5.50 |

*Minimum order: 1 each. Price based on an order quantity of 50 (CAT. NO. FA12CH).

FROM ONLY
£5.50*



NOTE: Wall anchor screws not included





CRL ALUMINIUM SHELVING EXTRUSION

- Designed to support glass shelves without a lot of visible metal
- Easy to install
- 2.4m stock length that you cut to size

| CAT. NO. | FINISH | GLASS THICKNESS | 1 | 10 |
|----------|----------------|-----------------|--------|--------|
| SE1496BA | Brite Anodised | 6mm | £29.40 | £27.20 |
| SE1496BN | Brushed Nickel | 6mm | £32.05 | £29.55 |
| SE3896BA | Brite Anodised | 10mm | £38.60 | £35.60 |
| SE3896BN | Brushed Nickel | 10mm | £42.95 | £39.60 |

*Minimum order: 1 each. Price based on an order quantity of 10 (CAT. NO. SE1496BA).

FROM ONLY **£27.20***

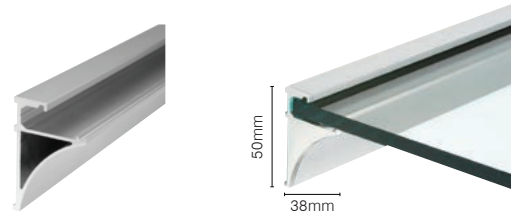

NOTE: End caps are sold separately, see below.

CRL END CAPS FOR ALUMINIUM SHELVING EXTRUSION

- Made of injection molded plastic and easily installed with EURTIV408C clear silicone
- Cover exposed edges of our aluminium shelving extrusions
- Formed and shaped to fit, ready to install
- Sold in pairs

| CAT. NO. | FINISH | USE WITH | 1 | 10 |
|----------|----------------|----------|-------|-------|
| END14BA | Brite Anodised | SE1496BA | £1.30 | £1.20 |
| END14BN | Brushed Nickel | SE1496BN | £1.30 | £1.20 |
| END38BA | Brite Anodised | SE3896BA | £1.40 | £1.30 |
| END38BN | Brushed Nickel | SE3896BN | £1.40 | £1.30 |

*Minimum order: 1 pair. Price based on an order quantity of 10 pairs (CAT. NO. END14BA).

FROM ONLY **£1.20***
PER PAIR

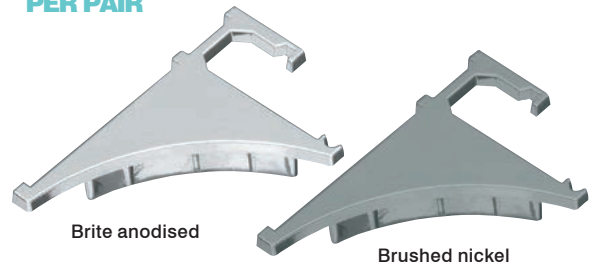

Brite anodised

Brushed nickel

CRL STICK-ON FINGER PULLS

- Perfect for sliding showcase and cabinet glass doors
- Easy-to-install, just peel and stick
- Available in five popular colours online at crlaurence.co.uk
- 19mm wide x 70mm long x 3.2mm deep

| CAT. NO. | COLOUR | QTY/PACK | 1 | 5 | 50 | 100 | 300 |
|----------|--------|----------|--------|--------|-------|-------|-------|
| FP88 | Clear | 1 | £0.46 | - | £0.41 | £0.37 | £0.33 |
| FP86 | Silver | 1 | £0.46 | - | £0.41 | £0.37 | £0.33 |
| FP88BX | Clear | 100 | £27.80 | £25.70 | - | - | - |
| FP86BX | Silver | 100 | £27.80 | £25.70 | - | - | - |

*Minimum order: 1 each. Price based on an order quantity of 300 (CAT. NO. FP88).

FROM ONLY **£0.33***

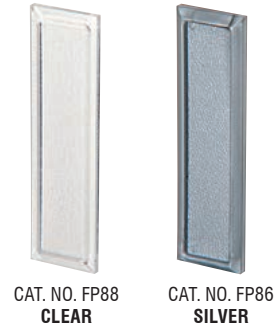

CAT. NO. FP88
CLEAR

CAT. NO. FP86
SILVER

CRL THREADED FINGER PULL FOR GLASS DOORS

- Designed for 'all glass' showcase and cabinet doors
- Requires drilling a 22mm hole in glass
- Easy to install in glass from 6mm to 8mm thick

| CAT. NO. | FINISH | 1 | 50 |
|----------|-----------|-------|-------|
| KV836 | Anochrome | £1.26 | £1.15 |

*Minimum order: 1 each. Price based on an order quantity of 50.

FROM ONLY **£1.15***





CRL CABO SLIDING SHOWER DOOR

- For use with 8, 10 or 12mm toughened glass
- Featuring the double soft-brake system
- Concealed overhead roller design
- Available in five architectural finishes



Square clamp shown on sliding panel



Bottom floor guide included



Cabo 180 Degree Kit includes:

- 1 - 2.13m length header support bar
- 2 - Top clamps with covers
- 2 - Wall mount brackets
- 2 - Top fixed glass fasteners with covers
- 1 - Bottom guide

NOTE: Bottom fixed glass attachments, handles or knobs must be ordered separately.



Square Clamp Style



Rounded Clamp Style

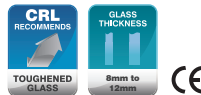

THE NEXT GENERATION IN SURFACE PROTECTION
SEE PAGE 29

FROM ONLY £310.80*

| CAT. NO. | DESCRIPTION | FINISH | 1 | 6 | 12 |
|-----------------|---------------------------------------|--------|---------|---------|---------|
| CABR84CH | Rounded Style 180 Degree kit | Chrome | £377.35 | £345.90 | £319.30 |
| CABS84CH | Square Style 180 Degree kit | Chrome | £367.30 | £336.70 | £310.80 |
| CAB90CH | 90 Degree wall-to-glass accessory kit | Chrome | £168.25 | £154.20 | £142.35 |

*Minimum order: 1 each. Price based on an order quantity of 12 (CAT. NO. CABS84CH).





CRL DELUXE SERENITY SERIES SLIDING SHOWER DOOR SYSTEM

• For use with 8 to 10mm monolithic toughened glass

CAT. NO. SER78BS BRUSHED STAINLESS DELUXE 180 DEGREE KIT

CAT. NO. SER78PS POLISHED STAINLESS DELUXE 180 DEGREE KIT

Deluxe 180 Degree Kit Includes:

- 1 - 2m length header support bar
- 4 - Rollers
- 1 - Stopper
- 2 - Track holder fittings for wall
- 2 - Track holder fittings for fixed panel
- 1 - Thru-glass pull
- 1 - Door guide
- 1 - 2.16m length clear L-jamb

FROM ONLY
£185.60*

IDEAL FOR SHOWROOMS

VISIT crlaurence.co.uk
and view CAT. NO. EUSLUK14



Image shown here:
CAT. NO. SER90BS



| CAT. NO. | DESCRIPTION | FINISH | 1 | 6 |
|-----------|--------------------------------|--------------------|---------|---------|
| SER78BS | Deluxe 180 Degree Serenity Kit | Brushed Stainless | £206.00 | £185.60 |
| SER78PS | Deluxe 180 Degree Serenity Kit | Polished Stainless | £222.35 | £201.95 |
| SER90BS | 90 Degree Accessory Kit | Brushed Stainless | £6.30 | £5.70 |
| SER90PS | 90 Degree Accessory Kit | Polished Stainless | £6.60 | £6.05 |
| SERAHW2BS | Track Holder Fittings for Wall | Brushed Stainless | £17.65 | £15.95 |
| SERAHW2PS | Track Holder Fittings for Wall | Polished Stainless | £20.50 | £18.45 |

*Price based on order quantity of 6 (CAT. NO. SER78BS).
Minimum order: 1 each. Finishes can be combined for quantity pricing.
90 degree accessory kit sold separately. Glass not included.

SEE THE COMPLETE RANGE

VISIT crlaurence.co.uk
and view CAT. NO. SDH17UK



MIRROR AND SHOWER ESSENTIALS





CRL HYDROSLIDE SLIDING SHOWER DOOR SYSTEM

- For use with 8mm to 10mm monolithic toughened glass
- Excellent design for compact areas
- Quick and easy installation
- Clean, sleek lines
- Available in four stock finishes, custom finishes available
- Custom units available by special order

CAT. NO. HYDK60CH Brite Anodised/Chrome
180 Degree Standard Kit 1524mm

CAT. NO. HYDK84CH Brite Anodised/Chrome
180 Degree Standard Kit 2134mm

180 DEGREE STANDARD KIT CONSISTS OF:

- 1 - Sliding glass door upper track
- 2 - Hangers for sliding glass door
- 2 - Sliding glass door rollers
- 2 - Sliding glass door roller stops
- 1 - Sliding glass door floor guide
- 2 - 90 degree wall-to-upper track connectors
- 2 - 180 degree glass-to-sliding track connectors
- 1 - 914mm half-round SDT980 threshold
- 1 - 2489mm DK98L L-seal for wall

NOTE: Bottom fixed glass attachments, handles or knobs must be ordered separately.

90 DEGREE** WALL-TO-GLASS ACCESSORY KIT CONSISTS OF:

- 1 - 90 degree glass-to-sliding track connector
- 1 - 90 degree wall-to-glass bracket

**90 degree units require that you order one 180 degree Standard Kit plus one 90 degree Accessory Kit



CAT. NO. HYDA9
90 Degree Kit



FROM ONLY
£148.95*

| CAT. NO. | DESCRIPTION | FINISH | 1 | 6 |
|-----------------|---------------------------------------|-------------------------|---------|---------|
| HYDK60CH | Standard 180 degree kit 1524mm | Brite Anodised / Chrome | £166.00 | £148.95 |
| HYDK84CH | Standard 180 degree kit 2134mm | Brite Anodised / Chrome | £179.00 | £162.70 |
| HYDA9CH | 90 degree wall-to-glass accessory kit | Brite Anodised / Chrome | £45.75 | £41.65 |
| HYDK60BN | Standard 180 degree kit 1524mm | Brushed Nickel | £186.45 | £169.35 |
| HYDK84BN | Standard 180 degree kit 2134mm | Brushed Nickel | £199.45 | £183.10 |
| HYDA9BN | 90 degree wall-to-glass accessory kit | Brushed Nickel | £53.45 | £48.65 |

*Minimum order: 1 kit. Price based on an order quantity of 6 (CAT. NO. HYDK60CH).





GLASS RAILING HARDWARE



GLASS RAILING HARDWARE

Get your copy now!

Architectural Glass Fixings ▶
CAT. NO EUAGF15



contact us

Contact our technical advisers for more details on our architectural glass fixings
CRL@crlaurence.co.uk or **00 800 0421 6144**



TAPER-LOC[®] X

DRY GLAZE RAILING SYSTEM

LIGHTER, MORE AFFORDABLE AND EVEN STRONGER!

Install Glass Railings with ease...

- 50% faster to install than alternatives
- Save Time and Money - The horizontal TAPER-LOC[®] design allows the system to be adjusted, dismantled and re-set
- Meets BS 6180: 2011 requirements
- For use with monolithic and laminated toughened glass
- Easy installation with one compact installation/removal tool

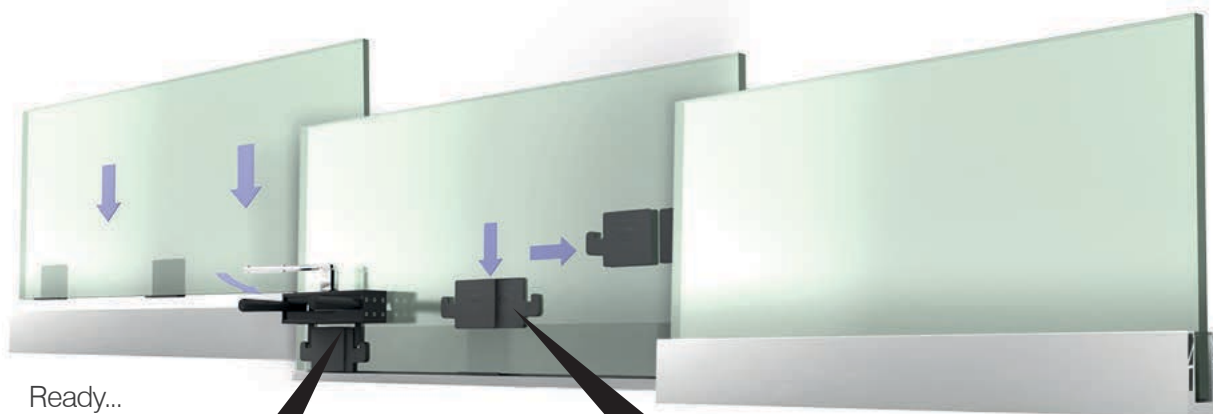

Ready...

Set...

Done.

The TAPER-LOC[®] Installation/Removal Tool compresses the Tapers together to lock the glass in place

TAPER-LOC[®] Tapers insert into the Aluminium Base Shoe

U.S. Patent Numbers 8,122,654 & 8,201,366
and Commonwealth of Australia Patent Numbers
2008207524 and 2012202256



Order your free copy
from taper-loc.co.uk

CAT. NO. EUTL14



To see a demonstration, visit taper-loc.co.uk

NEW

CRL 9BL AND 8B SERIES ALUMINIUM BASE SHOES

NOW 30% LIGHTER

- For use with CRL TAPER-LOC® System
- Can be clad in 6 standard architectural finishes
- Also available in satin anodised and brushed nickel finishes - no need for cladding!
- Only laminated system pursuing ICC-ES approval
- Bottom and side drilled base shoe available

FROM ONLY
£111.95*

SAVE
10%

INNOVATIVE EXTRUDED STRUCTURE



| CAT. NO. | GLASS TYPE | GLASS THICKNESS | DRILLED PATTERN | FINISH | USE WITH TAPERS | 1 | 6 |
|-----------------|----------------------|-----------------|-----------------|----------------|-----------------|---------|---------|
| 9BL68D | Laminated toughened | 17.52mm | Bottom drilled | Mill | LTL96X | £140.75 | £126.65 |
| 9BL68DBN | Laminated toughened | 17.52mm | Bottom drilled | Brushed Nickel | LTL96X | £151.75 | £136.55 |
| 9BL68DSA | Laminated toughened | 17.52mm | Bottom drilled | Satin Anodised | LTL96X | £154.75 | £139.25 |
| 9BL68F | Laminated toughened | 17.52mm | Side drilled | Mill | LTL96X | £140.75 | £126.65 |
| 9BL21D | Laminated toughened | 21.52mm | Bottom drilled | Mill | LTL10X | £136.55 | £125.65 |
| 9BL21DBN | Laminated toughened | 21.52mm | Bottom drilled | Brushed Nickel | LTL10X | £146.75 | £135.05 |
| 9BL21DSA | Laminated toughened | 21.52mm | Bottom drilled | Satin Anodised | LTL10X | £146.75 | £135.05 |
| 9BL21F | Laminated toughened | 21.52mm | Side drilled | Mill | LTL10X | £136.55 | £125.65 |
| 8B10D | Monolithic toughened | 12mm | Bottom drilled | Mill | TL5X10 | £124.55 | £112.10 |
| 8B10DBN | Monolithic toughened | 12mm | Bottom drilled | Brushed Nickel | TL5X10 | £134.25 | £120.85 |
| 8B10DSA | Monolithic toughened | 12mm | Bottom drilled | Satin Anodised | TL5X10 | £136.85 | £123.15 |
| 8B10F | Monolithic toughened | 12mm | Side drilled | Mill | TL5X10 | £124.55 | £112.10 |
| 8B58D | Monolithic toughened | 15mm | Bottom drilled | Mill | TL5X10 | £124.35 | £111.95 |
| 8B58DBN | Monolithic toughened | 15mm | Bottom drilled | Brushed Nickel | TL5X10 | £134.25 | £120.85 |
| 8B58DSA | Monolithic toughened | 15mm | Bottom drilled | Satin Anodised | TL5X10 | £136.60 | £122.95 |
| 8B58F | Monolithic toughened | 15mm | Side drilled | Mill | TL5X10 | £124.35 | £111.95 |
| 8B34D | Monolithic toughened | 19mm | Bottom drilled | Mill | TL5X10 | £128.65 | £115.75 |
| 8B34DBN | Monolithic toughened | 19mm | Bottom drilled | Brushed Nickel | TL5X10 | £138.65 | £124.75 |
| 8B34DSA | Monolithic toughened | 19mm | Bottom drilled | Satin Anodised | TL5X10 | £141.55 | £127.45 |
| 8B34F | Monolithic toughened | 19mm | Side drilled | Mill | TL5X10 | £128.65 | £115.75 |

*Minimum order: 1 each. Price based on an order quantity of 6 (CAT. NO. 8B58D).
Price includes 10% discount. Special discount available from 1st September to 31st December 2016.

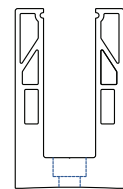

Bottom Drilled Hole Pattern "D"

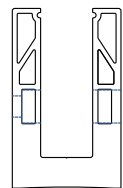

Side Drilled Hole Pattern "F"

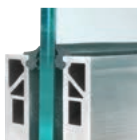

Gasket Retention Groove
Secures the Top Rubber
in the Base Shoe





CRL LARGE D SHAPE FLAT BACK GLASS CLAMPS

SAVE
10%

FROM ONLY
£1.45*

- For use on mezzanines, partitions, railings and windbreaks
- Steel pin included for additional glass support
- For 8 to 12.76mm toughened or laminated glass • Sold individually

Rubber gaskets are sold separately, CAT. NO.'s EUZ8G to EUZ1276G

| CAT. NO. | FINISH | SIZE | 1 | 50 | 100 | 500 |
|----------|--------------------|----------------|-------|-------|-------|-------|
| EUZFBBS | Brushed Stainless | 63 x 45 x 30mm | £5.65 | £5.10 | £4.65 | £4.25 |
| EUZFBPS | Polished Stainless | 63 x 45 x 30mm | £6.65 | £6.00 | £5.30 | £5.00 |
| EUZFBZ | Raw Zinc | 63 x 45 x 30mm | £1.95 | £1.75 | £1.60 | £1.45 |
| EUZFBBN | Brushed Nickel | 63 x 45 x 30mm | £2.40 | £2.20 | £2.00 | £1.80 |

*Minimum order: 1 each. Price based on an order quantity of 500 (CAT. NO. EUZFBZ).
Price includes 10% discount. Special discount available from 1st September to 31st December 2016.

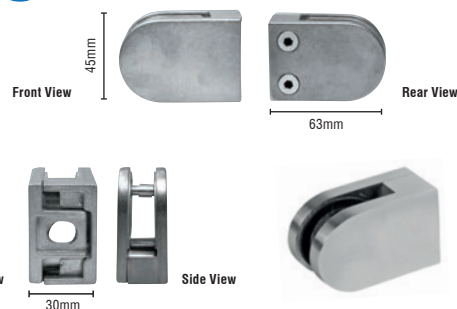

CRL LARGE D SHAPE 42.4MM RADIUS BACK GLASS CLAMPS

FROM ONLY
£2.20*

- Radius back for use with 42.4mm diameter posts
- For use on mezzanines, partitions, railings and windbreaks
- Steel pin included for additional glass support
- For 8 to 12.76mm toughened or laminated glass
- Sold individually

Rubber gaskets are sold separately, CAT. NO.'s EUZ8G to EUZ1276G

| CAT. NO. | FINISH | SIZE | 1 | 50 | 100 | 500 |
|----------|--------------------|----------------|-------|-------|-------|-------|
| EUZ42RBS | Brushed Stainless | 63 x 45 x 30mm | £6.70 | £6.00 | £5.50 | £5.00 |
| EUZ42RPS | Polished Stainless | 63 x 45 x 30mm | £7.75 | £7.00 | £6.35 | £5.85 |
| EUZ42RBN | Brushed Nickel | 63 x 45 x 30mm | £2.95 | £2.60 | £2.40 | £2.20 |

*Minimum order: 1 each. Price based on an order quantity of 500 (CAT. NO. EUZ42RBN).

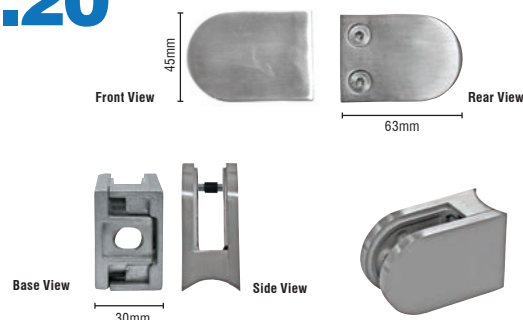

CRL LARGE D SHAPE 48.3MM RADIUS BACK GLASS CLAMPS

FROM ONLY
£2.20*

- Radius back for use with 48.3mm diameter posts
- For use on mezzanines, partitions, railings and windbreaks
- Steel pin included for additional glass support
- For 8 to 12.76mm toughened or laminated glass
- Sold individually

Rubber gaskets are sold separately, CAT. NO.'s EUZ8G to EUZ1276G

| CAT. NO. | FINISH | SIZE | 1 | 50 | 100 | 500 |
|----------|--------------------|----------------|-------|-------|-------|-------|
| EUZ48RBS | Brushed Stainless | 63 x 45 x 30mm | £6.70 | £6.00 | £5.50 | £5.00 |
| EUZ48RPS | Polished Stainless | 63 x 45 x 30mm | £7.75 | £7.00 | £6.35 | £5.85 |
| EUZ48RBN | Brushed Nickel | 63 x 45 x 30mm | £2.95 | £2.60 | £2.40 | £2.20 |

*Minimum order: 1 each. Price based on an order quantity of 500 (CAT. NO. EUZ48RBN).

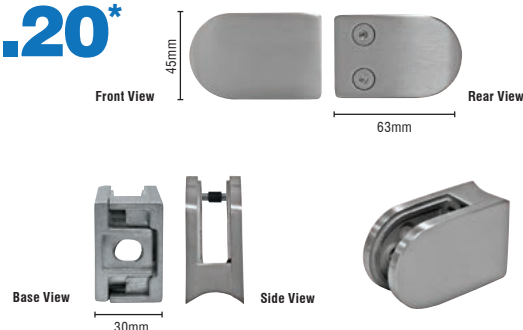

CRL RUBBER GASKETS FOR EUZFB/EUZ42/EUZ48 SERIES CLAMPS

FROM ONLY
£0.21*
PER PAIR

- For use with toughened or laminated glass
- Sold by the pair • Black colour

For use with EUZFB, EUZ42 and EUZ48 Series Clamps

| CAT. NO. | THICKNESS | GLASS TYPE | 1 | 50 | 100 | 500 |
|----------|-----------|------------|-------|-------|-------|-------|
| EUZ8G | 8mm | Toughened | £0.31 | £0.26 | £0.23 | £0.21 |
| EUZ876G | 8.76mm | Laminated | £0.31 | £0.26 | £0.23 | £0.21 |
| EUZ10G | 10mm | Toughened | £0.31 | £0.26 | £0.23 | £0.21 |
| EUZ1076G | 10.76mm | Laminated | £0.31 | £0.26 | £0.23 | £0.21 |
| EUZ12G | 12mm | Toughened | £0.31 | £0.26 | £0.23 | £0.21 |
| EUZ1276G | 12.76mm | Laminated | £0.31 | £0.26 | £0.23 | £0.21 |

*Minimum order: 1 pair. Price based on an order quantity of 500 pairs (CAT. NO. EUZ8G).





CRL FLAT BACK GLASS CLAMPS

- For use on mezzanines, partitions, railings and windbreaks
- Available in 316 grade brushed or polished stainless steel
- For 10 and 12mm glass
- Comes complete with gaskets for monolithic toughened glass
- Sold Individually

For laminated glass, use gasket CAT. NO. EUZ5GASK107
For support plate, order CAT. NO. EUZ5SUPP0RT

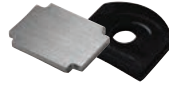

| CAT. NO. | FINISH | SIZE | 1 | 6 |
|------------|--------------------|----------------|--------|--------|
| EUZ51012BS | Brushed Stainless | 63 x 45 x 27mm | £12.50 | £11.40 |
| EUZ51012PS | Polished Stainless | 63 x 45 x 27mm | £13.75 | £12.50 |

*Minimum order: 1 each. Price based on an order quantity of 6 (CAT. NO. EUZ51012BS).

FROM ONLY
£11.40*

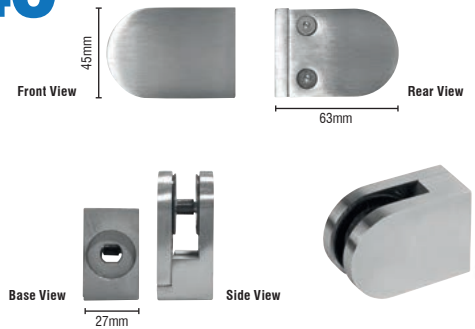

CRL RADIUS BACK GLASS CLAMPS

- For use on mezzanines, partitions, railings and windbreaks
- Available in 316 grade brushed or polished stainless steel
- For 10 and 12mm glass
- Comes complete with gaskets for monolithic toughened glass • Sold Individually

For laminated glass, use gasket CAT. NO. EUZ5GASK107
For support plate, order CAT. NO. EUZ5SUPP0RT



| CAT. NO. | FINISH | SIZE | 1 | 6 |
|-------------|--------------------|----------------|--------|--------|
| EUZ51012RBS | Brushed Stainless | 63 x 45 x 27mm | £12.50 | £11.40 |
| EUZ51012RPS | Polished Stainless | 63 x 45 x 27mm | £13.75 | £12.50 |

*Minimum order: 1 each. Price based on an order quantity of 6 (CAT. NO. EUZ51012RBS).

FROM ONLY
£11.40*

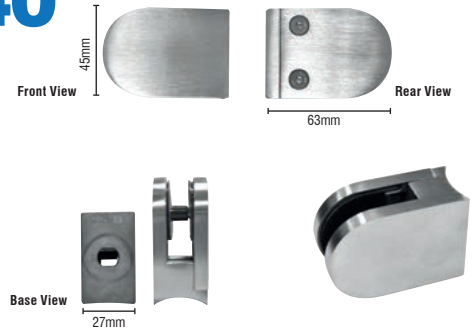

CRL SQUARE TYPE FLAT BACK GLASS CLAMPS

- For use on mezzanines, partitions, railings and windbreaks
- For 8 to 10.76mm toughened or laminated glass • Sold individually

Rubber gaskets are sold separately, CAT. NO.'s EUZS8G to EUZS1076G

| CAT. NO. | FINISH | SIZE | 1 | 50 | 100 | 500 |
|-----------|--------------------|----------------|-------|-------|-------|-------|
| EUZSFBBBS | Brushed Stainless | 45 x 45 X 27mm | £4.30 | £3.90 | £3.55 | £3.20 |
| EUZSFBPS | Polished Stainless | 45 x 45 X 27mm | £5.45 | £4.95 | £4.50 | £4.15 |
| EUZSFBBZ | Raw Zinc | 45 x 45 X 27mm | £1.45 | £1.30 | £1.20 | £1.10 |
| EUZSFBBN | Brushed Nickel | 45 x 45 x 27mm | £2.25 | £2.05 | £1.85 | £1.70 |

*Minimum order: 1 each. Price based on an order quantity of 500 (CAT. NO. EUZSFBBZ).
Price includes 10% discount. Special discount available from 1st September to 31st December 2016.

FROM ONLY
£1.10*

**SAVE
10%**

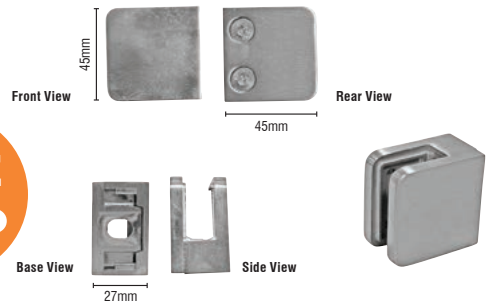

CRL RUBBER GASKETS FOR EUZSF SERIES CLAMPS

- For use with toughened or laminated glass
- Sold by the pair
- Black color

For use with EUZSF Series Clamps

| CAT. NO. | THICKNESS | GLASS TYPE | 1 | 50 | 100 | 500 |
|-----------|-----------|------------|-------|-------|-------|-------|
| EUZS8G | 8mm | Toughened | £0.26 | £0.20 | £0.18 | £0.16 |
| EUZS876G | 8.76mm | Laminated | £0.26 | £0.20 | £0.18 | £0.16 |
| EUZS10G | 10mm | Toughened | £0.26 | £0.20 | £0.18 | £0.16 |
| EUZS1076G | 10.76mm | Laminated | £0.26 | £0.20 | £0.18 | £0.16 |

*Minimum order: 1 pair. Price based on an order quantity of 500 pairs (CAT. NO. EUZS8G).

FROM ONLY
£0.16*
PER PAIR





CRL SQUARE TYPE FLAT BACK GLASS CLAMPS

- For use on mezzanines, partitions, railings and windbreaks
- Side plates for use with laminated glass
- For 6 to 12.76mm toughened or laminated glass
- Safety pin included • Sold individually

Rubber gaskets are sold separately, see chart below for options, from CAT. NO.'s EUZLS6GL to EUZLS1276GL

| CAT. NO. | FINISH | SIZE | 1 | 50 | 100 | 500 |
|------------|-------------------|----------------|--------|-------|-------|-------|
| EUZLSFBBSL | Brushed Stainless | 55 x 55 x 35mm | £10.45 | £9.45 | £8.55 | £7.85 |
| EUZLSFBZL | Raw Zinc | 55 x 55 x 35mm | £2.90 | £2.70 | £2.20 | £2.05 |

*Minimum order: 1 each. Price based on an order quantity of 500 (CAT. NO. EUZLSFBZL).

FROM ONLY
£2.05*

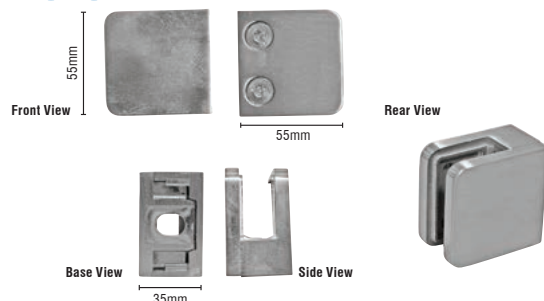

CRL SQUARE TYPE 42.4MM RADIUS BACK GLASS CLAMPS

- Radius back for use with 42.4mm diameter posts
- For use on mezzanines, partitions, railings and windbreaks
- Side plates for use with laminated glass included
- For 6 to 12.76mm toughened or laminated glass
- Safety pin included • Sold individually

Rubber gaskets are sold separately, see chart below for options, from CAT. NO.'s EUZLS6GL to EUZLS1276GL

| CAT. NO. | FINISH | SIZE | 1 | 50 | 100 | 500 |
|-------------|-------------------|----------------|--------|-------|-------|-------|
| EUZLS42RBSL | Brushed Stainless | 55 x 55 x 35mm | £10.45 | £9.45 | £8.55 | £7.85 |
| EUZLS42RZL | Raw Zinc | 55 x 55 x 35mm | £2.90 | £2.70 | £2.20 | £2.05 |

*Minimum order: 1 each. Price based on an order quantity of 500 (CAT. NO. EUZLS42RZL).

FROM ONLY
£2.05*

ECONOMY RANGE

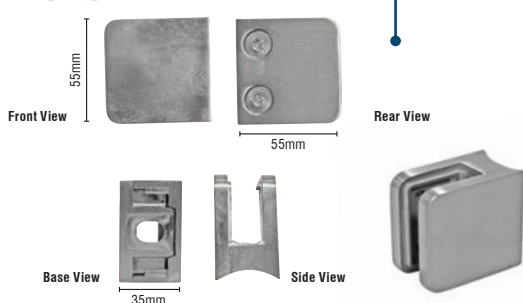

CRL SQUARE TYPE 48.3MM RADIUS BACK GLASS CLAMPS

- Radius back for use with 48.3mm diameter posts
- For use on mezzanines, partitions, railings and windbreaks
- Side plates for use with laminated glass included
- For 6 to 12.76mm toughened or laminated glass
- Safety pin included • Sold individually

Rubber gaskets are sold separately, see chart below for options, from CAT. NO.'s EUZLS6GL to EUZLS1276GL

| CAT. NO. | FINISH | SIZE | 1 | 50 | 100 | 500 |
|-------------|-------------------|----------------|--------|-------|-------|-------|
| EUZLS48RBSL | Brushed Stainless | 55 x 55 x 35mm | £10.45 | £9.45 | £8.55 | £7.85 |
| EUZLS48RZL | Raw Zinc | 55 x 55 x 35mm | £2.90 | £2.70 | £2.20 | £2.05 |

*Minimum order: 1 each. Price based on an order quantity of 500 (CAT. NO. EUZLS48RZL).

FROM ONLY
£2.05*

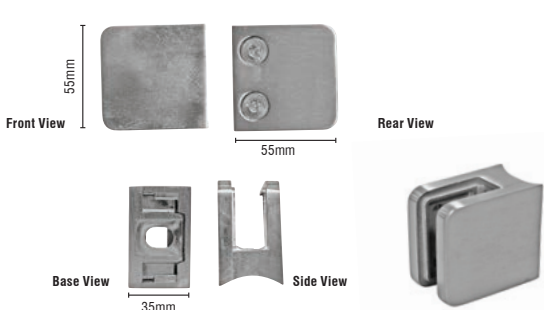

CRL RUBBER GASKETS FOR EUZLSF/EUZLS42/EUZLS48 SERIES CLAMPS

- For use with toughened or laminated glass • Sold by the pair • Black colour

| CAT. NO. | THICKNESS | GLASS TYPE | 1 | 50 | 100 | 500 |
|-------------|-----------|------------|-------|-------|-------|-------|
| EUZLS6GL | 6mm | Toughened | £0.39 | £0.35 | £0.31 | £0.28 |
| EUZLS676GL | 6.76mm | Laminated | £0.39 | £0.35 | £0.31 | £0.28 |
| EUZLS8GL | 8mm | Toughened | £0.39 | £0.35 | £0.31 | £0.28 |
| EUZLS876GL | 8.76mm | Laminated | £0.39 | £0.35 | £0.31 | £0.28 |
| EUZLS10GL | 10mm | Toughened | £0.39 | £0.35 | £0.31 | £0.28 |
| EUZLS1076GL | 10.76mm | Laminated | £0.39 | £0.35 | £0.31 | £0.28 |
| EUZLS12GL | 12mm | Toughened | £0.39 | £0.35 | £0.31 | £0.28 |
| EUZLS1276GL | 12.76mm | Laminated | £0.39 | £0.35 | £0.31 | £0.28 |

*Minimum order: 1 pair. Price based on an order quantity of 500 pairs (CAT. NO. EUZLS6GL).

FROM ONLY
£0.28*
PER PAIR





COMMERCIAL HARDWARE

Get your copy now!

**CRL Office Partition
System Brochure**

CAT. NO. OPS15DEUK



Contact our technical advisers for more details on our office partition systems

CRL@crlaurence.co.uk or 00 800 0421 6144



CRL CLEAR GLASS JOINT SYSTEM 180° PARTITION STRIP

- Provides a clear slimline finish between two glass panels
- Excellent adhesion from pre-applied high bond tape
- 3m lengths

| CAT. NO. | GLASS THICKNESS | GLASS TYPE | 1 | 25 | 50 |
|----------|-----------------|------------|-------|-------|-------|
| EZCC10 | 10mm | Toughened | £6.60 | £5.95 | £5.45 |
| EZCC108 | 10.8mm | Laminated | £6.60 | £5.95 | £5.45 |
| EZCC12 | 12mm | Toughened | £6.75 | £6.15 | £5.65 |
| EZCC128 | 12.8mm | Laminated | £6.75 | £6.15 | £5.65 |

*Minimum order: 1 each. Price based on an order quantity of 50 (CAT. NO. EZCC108). Must ship common carrier.

FROM ONLY **£5.45***

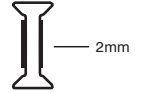

CRL CLEAR GLASS JOINT SYSTEM 90° CORNER PROTECTION STRIP

- Provides a clear slimline finish between two glass panels
- Excellent adhesion from pre-applied high bond tape
- 3m lengths

| CAT. NO. | GLASS THICKNESS | GLASS TYPE | 1 | 25 | 50 |
|----------|-----------------|------------|-------|-------|-------|
| EZCL10 | 10mm | Toughened | £7.20 | £6.50 | £5.95 |
| EZCL108 | 10.8mm | Laminated | £7.20 | £6.50 | £5.95 |
| EZCL12 | 12mm | Toughened | £7.45 | £6.70 | £6.10 |
| EZCL128 | 12.8mm | Laminated | £7.45 | £6.70 | £6.10 |

*Minimum order: 1 each. Price based on an order quantity of 50 (CAT. NO. EZCL10). Must ship common carrier.

FROM ONLY **£5.95***

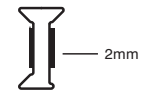

CRL CLEAR GLASS JOINT SYSTEM 3-WAY PARTITION STRIP

- Provides a clear slimline finish between two glass panels
- Excellent adhesion from pre-applied high bond tape
- 3m lengths

| CAT. NO. | GLASS THICKNESS | GLASS TYPE | 1 | 25 | 50 |
|----------|-----------------|------------|--------|--------|-------|
| EZCT10 | 10mm | Toughened | £11.20 | £10.10 | £9.20 |
| EZCT108 | 10.8mm | Laminated | £11.20 | £10.10 | £9.20 |
| EZCT12 | 12mm | Toughened | £11.65 | £10.50 | £9.55 |
| EZCT128 | 12.8mm | Laminated | £11.65 | £10.50 | £9.55 |

*Minimum order: 1 each. Price based on an order quantity of 50 (CAT. NO. EZCT10). Must ship common carrier.

FROM ONLY **£9.20***

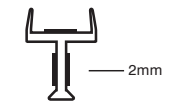

CRL CLEAR GLASS JOINT SYSTEM ABUTMENT STRIP

- Provides a clear slimline finish between two glass panels
- Excellent adhesion from pre-applied high bond tape
- 3m lengths

| CAT. NO. | GLASS THICKNESS | GLASS TYPE | 1 | 25 | 50 |
|----------|-----------------|------------|-------|-------|-------|
| EZCE10 | 10mm | Toughened | £7.75 | £7.10 | £6.15 |
| EZCE108 | 10.8mm | Laminated | £7.75 | £7.10 | £6.15 |
| EZCE12 | 12mm | Toughened | £8.05 | £7.35 | £6.40 |
| EZCE128 | 12.8mm | Laminated | £8.05 | £7.35 | £6.40 |

*Minimum order: 1 each. Price based on an order quantity of 50 (CAT. NO. EZCE10). Must ship common carrier.

FROM ONLY **£6.15***

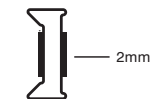



CRL CLEAR GLASS JOINT SYSTEM 180° IN-LINE 2-WAY PARTITION STRIP

- Clips over the glass joint
- 3m lengths
- Does not feature clear high bond tape

| CAT. NO. | GLASS THICKNESS | GLASS TYPE | 1 | 25 | 50 |
|----------|-----------------|------------|-------|-------|-------|
| CLON10 | 10mm | Toughened | £5.40 | £4.85 | £4.50 |
| CLON108 | 10.8mm | Laminated | £5.40 | £4.85 | £4.50 |
| CLON12 | 12mm | Toughened | £6.00 | £5.55 | £5.05 |
| CLON128 | 12.8mm | Laminated | £6.00 | £5.55 | £5.05 |

*Minimum order: 1 each. Price based on an order quantity of 50 (CAT. NO. CLON10). Must ship common carrier.

FROM ONLY **£4.50***



CRL CLEAR GLASS JOINT SYSTEM 90° 2-WAY PARTITION STRIP

- Clips over the glass joint
- Excellent adhesion from pre-applied clear high bond tape
- 3m lengths

| CAT. NO. | GLASS THICKNESS | GLASS TYPE | 1 | 25 | 50 |
|----------|-----------------|------------|-------|-------|-------|
| CLON210 | 10mm | Toughened | £7.80 | £7.10 | £6.50 |
| CLON2108 | 10.8mm | Laminated | £7.80 | £7.10 | £6.50 |
| CLON212 | 12mm | Toughened | £8.45 | £7.65 | £7.00 |
| CLON2128 | 12.8mm | Laminated | £8.45 | £7.65 | £7.00 |

*Minimum order: 1 each. Price based on an order quantity of 50 (CAT. NO. CLON210). Must ship common carrier.

FROM ONLY **£6.50***

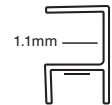

CRL CLEAR GLASS JOINT SYSTEM 90° 3-WAY PARTITION STRIP

- Clips over the glass joint
- Excellent adhesion from pre-applied clear high bond tape
- 3m lengths

| CAT. NO. | GLASS THICKNESS | GLASS TYPE | 1 | 25 | 50 |
|----------|-----------------|------------|-------|-------|-------|
| CLON310 | 10mm | Toughened | £7.65 | £6.95 | £6.40 |
| CLON3108 | 10.8mm | Laminated | £7.65 | £6.95 | £6.40 |
| CLON312 | 12mm | Toughened | £8.30 | £7.55 | £6.90 |
| CLON3128 | 12.8mm | Laminated | £8.30 | £7.55 | £6.90 |

*Minimum order: 1 each. Price based on an order quantity of 50 (CAT. NO. CLON310). Must ship common carrier.

FROM ONLY **£6.40***

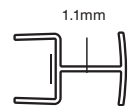

CRL CLEAR GLASS JOINT SYSTEM 135° 2-WAY PARTITION STRIP

- Clips over the glass joint
- Excellent adhesion from pre-applied clear high bond tape
- 3m lengths

| CAT. NO. | GLASS THICKNESS | GLASS TYPE | 1 | 25 | 50 |
|----------|-----------------|------------|--------|--------|-------|
| CLON410 | 10mm | Toughened | £10.70 | £9.70 | £8.95 |
| CLON4108 | 10.8mm | Laminated | £10.70 | £9.70 | £8.95 |
| CLON412 | 12mm | Toughened | £11.50 | £10.50 | £9.60 |
| CLON4128 | 12.8mm | Laminated | £11.50 | £10.50 | £9.60 |

*Minimum order: 1 each. Price based on an order quantity of 50 (CAT. NO. CLON410). Must ship common carrier.

FROM ONLY **£8.95***

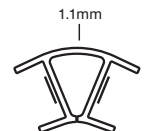



CRL GLASS MOUNTED LATCH WITH LOCK AND THUMBTURN

- Works on single or double doors
- Field reversible
- Glass fabrication required
- For 10 or 12mm glass
- 174mm overall length
- 304 Grade stainless steel
- Other finishes available
- Lever handles ordered separately, see our full line of handles at crlaurence.co.uk

| CAT. NO. | FINISH | 1 | 6 |
|----------|-------------------|--------|--------|
| PTH311BS | Brushed Stainless | £45.70 | £41.55 |

*Minimum order: 1 each. Price based on an order quantity of 6.
Price includes 10% discount. Special discount available from 1st September to 31st December 2016.

FROM ONLY
£41.55*

SAVE
10%



CRL PTH SERIES GLASS MOUNTED PATCH LOCK KEEPERS

- For 10 or 12mm glass
- Glass fabrication required
- Stamped body with finish cover plates included
- 304 grade stainless steel
- Over finishes available
- Work with CAT. NO. PTH311BS latch

| CAT. NO. | FINISH | LENGTH | HEIGHT | 1 | 6 |
|----------|-------------------|--------|--------|--------|--------|
| PTH314BS | Brushed Stainless | 174mm | 74mm | £25.45 | £22.90 |
| PTH315BS | Brushed Stainless | 70mm | 74mm | £25.45 | £22.90 |

*Minimum order: 1 each. Price based on an order quantity of 6 (CAT. NO. PTH314BS).
Price includes 10% discount. Special discount available from 1st September to 31st December 2016.

FROM ONLY
£22.90*

SAVE
10%



CAT. NO. PTH314BS

CAT. NO. PTH315BS

CRL T-STYLE DOOR PULL HANDLES

- Lengths from 300mm to 1 metre
- Grade 304 brushed stainless steel
- Sold per pair

| CAT. NO. | LENGTH | DIAMETER | 1 | 5 |
|--------------|--------|----------|--------|--------|
| EULP30019BS | 300mm | 19mm | £25.55 | £19.15 |
| EULP40019BS | 400mm | 19mm | £27.75 | £20.85 |
| EULP50019BS | 500mm | 25mm | £30.55 | £22.90 |
| EULP60032BS | 600mm | 32mm | £35.15 | £26.40 |
| EULP100032BS | 1000mm | 32mm | £57.95 | £43.50 |

*Minimum order: 1 pair. Price based on an order quantity of 5 pairs (CAT. NO. EULP30019BS).
Price includes 10% discount. Special discount available from 1st September to 31st December 2016.

FROM ONLY
£19.15*
PER PAIR

SAVE
10%



CRL EUR SERIES COMPLETE PATCH LOCK INCLUDING CYLINDER

- Can be mounted on top, bottom or side of doors
- High density cast body with lock mechanism
- For 10 or 12mm glass
- Bottom load cylinder
- Glass fabrication required
- Keepers ordered separately, for more details go to crlaurence.co.uk

| CAT. NO. | FINISH | 1 | 6 |
|----------|-------------------|--------|--------|
| EUR205BS | Brushed Stainless | £38.50 | £34.65 |

*Minimum order: 1 each. Price based on an order quantity of 6.
Price includes 10% discount. Special discount available from 1st September to 31st December 2016.

FROM ONLY
£34.65*

SAVE
10%





CRL CENTRE-HUNG FREE SWINGING TOP PIVOT

- Surface mount top pivot for use with patch fittings and CRL WEDGE-LOCK® Door Rail System
- Installs easily to wood or metal substrates

FROM ONLY **£2.25***

SAVE **10%**



| CAT. NO. | DESCRIPTION | 1 | 6 |
|----------|-------------------------------------|-------|-------|
| 1NT401 | Centre-Hung Free Swinging Top Pivot | £2.55 | £2.25 |

*Minimum order: 1 each. Price based on an order quantity of 6. Price includes 10% discount. Special discount available from 1st September to 31st December 2016.

CRL ADJUSTABLE POWER 180° FLOOR MOUNTED DOOR CLOSER

- The perfect door closer to support CRL's patch hardware
- Interchangeable spindle heights
- 120kg capacity, 1067mm wide doors
- Narrow 82mm width cement box
- EN3 medium strength floor spring
- Complete with cement box, brushed stainless cover plate and standard height spindle (other heights ordered separately)

FROM ONLY **£84.00***

SAVE **5%**

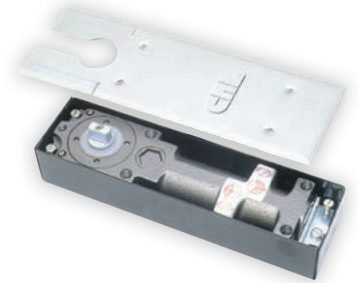

| CAT. NO. | DESCRIPTION | 1 | 6 | 48 | 96 |
|------------|---------------------------------|--------|--------|--------|--------|
| EUCRL8460V | Adjustable Floor Mounted Closer | £98.85 | £93.90 | £88.00 | £84.00 |

*Minimum order: 1 each. Price based on an order quantity of 96. Price includes 5% discount. Special discount available from 1st September to 31st December 2016.

CRL DOOR PATCH FITTING WITH INSERT

- 65mm pivot setback
- For 10 or 12mm glass
- Glass fabrication required, see more details online at crlaurence.co.uk

FROM ONLY **£19.65***

| CAT. NO. | DESCRIPTION | FINISH | INSERT | 1 | 6 |
|----------|---------------------------|--------------------|--------|--------|--------|
| PH21ABS | Top door patch fitting | Brushed Stainless | 1NT303 | £21.85 | £19.65 |
| PH21APS | Top door patch fitting | Polished Stainless | 1NT303 | £21.85 | £19.65 |
| PH11CBS | Bottom door patch fitting | Brushed Stainless | 1NT301 | £25.20 | £22.40 |
| PH11CPS | Bottom door patch fitting | Polished Stainless | 1NT301 | £25.20 | £22.40 |

*Minimum order: 1 each. Price based on an order quantity of 6 (CAT. NO. PH21ABS).



CRL TRANSOM PATCH WITH INSERT

- Works with both 65 and 70mm pivot setback door patch fittings
- Used to support a transom from a side jamb
- For 10 or 12mm glass
- Glass fabrication required, see more details online at crlaurence.co.uk

FROM ONLY **£19.60***

| CAT. NO. | DESCRIPTION | FINISH | INSERT | 1 | 6 |
|----------|--------------------------------|--------------------|--------|--------|--------|
| PH34BS | Wall mounted transom patch | Brushed Stainless | 1NT300 | £21.80 | £19.60 |
| PH34PS | Wall mounted transom patch | Polished Stainless | 1NT300 | £21.80 | £19.60 |
| PH40BS | Sidelite mounted transom patch | Brushed Stainless | 1NT300 | £38.55 | £34.65 |
| PH40PS | Sidelite mounted transom patch | Polished Stainless | 1NT300 | £38.55 | £34.65 |

*Minimum order: 1 each. Price based on an order quantity of 6 (CAT. NO. PH34BS).

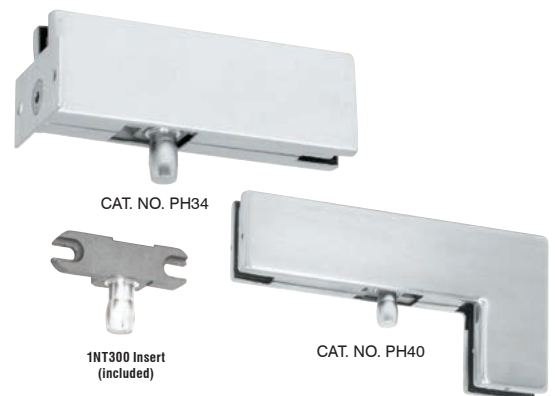



CRL OIL DYNAMIC HINGES FOR GLASS DOORS



CONFORMS TO EN1154:2006



CRL OIL DYNAMIC WALL-TO-GLASS HINGE

SAVE 10%

- Adjustable closing speed
- Swings in and out a full 90 degrees, with stops at 0°, +90°, and -90°
- Also available in no-hold open option
- 100kg max door weight
- 1000mm max door width
- For 8 to 13.52mm toughened glass



FROM ONLY **£82.80***

| CAT. NO. | DESCRIPTION | FINISH | 1 | 6 |
|-----------|---------------------|-----------------|--------|--------|
| 31M8010SN | Wall-to-Glass Hinge | Satin Nickel | £98.35 | £90.15 |
| 31M8010SA | Wall-to-Glass Hinge | Satin Anodised | £90.35 | £82.80 |
| 31M8010CH | Wall-to-Glass Hinge | Polished Chrome | £90.35 | £82.80 |

NO HOLD OPEN OPTION

| | | | | |
|-----------|---------------------|-----------------|--------|--------|
| 31M8210SN | Wall-to-Glass Hinge | Satin Nickel | £98.35 | £90.15 |
| 31M8210SA | Wall-to-Glass Hinge | Satin Anodised | £90.35 | £82.80 |
| 31M8210CH | Wall-to-Glass Hinge | Polished Chrome | £90.35 | £82.80 |

CLAD OPTION

| | | | | |
|------------|---------------------|--------------------|---------|--------|
| 31M8010CBS | Wall-to-Glass Hinge | Brushed Stainless | £98.35 | £90.15 |
| 31M8010CPS | Wall-to-Glass Hinge | Polished Stainless | £103.50 | £94.80 |

FOR HIGH HUMIDITY RESISTANCE IN DAMP ENVIRONMENTS

| | | | | |
|-------------|---------------------|-----------------|---------|--------|
| 31M8010BTSN | Wall-to-Glass Hinge | Satin Nickel | £106.15 | £97.25 |
| 31M8010BTSA | Wall-to-Glass Hinge | Satin Anodised | £99.05 | £90.75 |
| 31M8010BTCH | Wall-to-Glass Hinge | Polished Chrome | £99.05 | £90.75 |

*Minimum order: 1 each. Price based on an order quantity of 6 (CAT. NO. 31M8010CH). Price includes 10% discount. Special discount available from 1st September to 31st December 2016. All Oil Dynamic Hinges can be combined for quantity pricing.

CRL OIL DYNAMIC OFFSET WALL-TO-GLASS HINGE

SAVE 10%

- Adjustable closing speed
- Swings in and out a full 90 degrees, with stops at 0°, +90°, and -90°
- Also available in no-hold open option
- 100kg max door weight
- 1000mm max door width



FROM ONLY **£82.80***

| CAT. NO. | DESCRIPTION | FINISH | 1 | 6 |
|-----------|----------------------------|-----------------|--------|--------|
| 31M8011SN | Offset Wall-to-Glass Hinge | Satin Nickel | £98.35 | £90.15 |
| 31M8011SA | Offset Wall-to-Glass Hinge | Satin Anodised | £90.35 | £82.80 |
| 31M8011CH | Offset Wall-to-Glass Hinge | Polished Chrome | £90.35 | £82.80 |

NO HOLD OPEN OPTION

| | | | | |
|-----------|----------------------------|-----------------|--------|--------|
| 31M8211SN | Offset Wall-to-Glass Hinge | Satin Nickel | £98.35 | £90.15 |
| 31M8211SA | Offset Wall-to-Glass Hinge | Satin Anodised | £90.35 | £82.80 |
| 31M8211CH | Offset Wall-to-Glass Hinge | Polished Chrome | £90.35 | £82.80 |

FOR HIGH HUMIDITY RESISTANCE IN DAMP ENVIRONMENTS

| | | | | |
|-------------|----------------------------|-----------------|---------|--------|
| 31M8011BTSN | Offset Wall-to-Glass Hinge | Satin Nickel | £106.15 | £97.25 |
| 31M8011BTSA | Offset Wall-to-Glass Hinge | Satin Anodised | £99.05 | £90.75 |
| 31M8011BTCH | Offset Wall-to-Glass Hinge | Polished Chrome | £99.05 | £90.75 |

*Minimum order: 1 each. Price based on an order quantity of 6 (CAT. NO. 31M8011CH). Price includes 10% discount. Special discount available from 1st September to 31st December 2016. All Oil Dynamic Hinges can be combined for quantity pricing.

CRL OIL DYNAMIC GLASS-TO-GLASS HINGE

SAVE 10%

- Adjustable closing speed
- Swings in and out a full 90 degrees, with stops at 0°, +90°, and -90°
- Also available in no-hold open option
- 80kg max door weight
- 1000mm max door width
- For 8 to 13.52mm toughened glass



FROM ONLY **£111.60***

| CAT. NO. | DESCRIPTION | FINISH | 1 | 6 |
|-----------|----------------------|-----------------|---------|---------|
| 31M8015SN | Glass-to-Glass Hinge | Satin Nickel | £134.80 | £123.60 |
| 31M8015SA | Glass-to-Glass Hinge | Satin Anodised | £123.00 | £112.75 |
| 31M8015CH | Glass-to-Glass Hinge | Polished Chrome | £121.75 | £111.60 |

NO HOLD OPEN OPTION

| | | | | |
|-----------|----------------------|-----------------|---------|---------|
| 31M8215SN | Glass-to-Glass Hinge | Satin Nickel | £138.85 | £127.30 |
| 31M8215SA | Glass-to-Glass Hinge | Satin Anodised | £123.00 | £112.75 |
| 31M8215CH | Glass-to-Glass Hinge | Polished Chrome | £121.75 | £111.60 |

CLAD OPTION

| | | | | |
|------------|----------------------|--------------------|---------|---------|
| 31M8015CBS | Glass-to-Glass Hinge | Brushed Stainless | £132.15 | £121.15 |
| 31M8015CPS | Glass-to-Glass Hinge | Polished Stainless | £137.15 | £125.65 |

FOR HIGH HUMIDITY RESISTANCE IN DAMP ENVIRONMENTS

| | | | | |
|-------------|----------------------|-----------------|---------|---------|
| 31M8015BTSN | Glass-to-Glass Hinge | Satin Nickel | £143.95 | £131.95 |
| 31M8015BTSA | Glass-to-Glass Hinge | Satin Anodised | £126.95 | £116.35 |
| 31M8015BTCH | Glass-to-Glass Hinge | Polished Chrome | £130.75 | £119.95 |

*Minimum order: 1 each. Price based on an order quantity of 6 (CAT. NO. 31M8015CH). Price includes 10% discount. Special discount available from 1st September to 31st December 2016. All Oil Dynamic Hinges can be combined for quantity pricing.





CRL OIL DYNAMIC REBATED WALL-TO-GLASS HINGE

- Adjustable closing speed
- For use with rebated door frames
- Swings out 90 degrees
- Stops at 90 degrees
- Hold open
- 100kg max door weight
- 1000mm max door width
- For 8 to 12mm toughened glass



SAVE 10%

FROM ONLY **£82.80***

| CAT. NO. | DESCRIPTION | FINISH | 1 | 6 |
|-----------|---------------------|-----------------|--------|--------|
| 31M8060SN | Wall-to-Glass Hinge | Satin Nickel | £98.35 | £90.15 |
| 31M8060CH | Wall-to-Glass Hinge | Polished Chrome | £93.10 | £85.35 |

NO HOLD OPEN OPTION

| | | | | |
|-----------|---------------------|-----------------|--------|--------|
| 31M8260SN | Wall-to-Glass Hinge | Satin Nickel | £98.35 | £90.15 |
| 31M8260CH | Wall-to-Glass Hinge | Polished Chrome | £90.35 | £82.80 |

*Minimum order: 1 each. Price based on an order quantity of 6 (CAT. NO. 31M8260CH). Price includes 10% discount. Special discount available from 1st September to 31st December 2016. All Oil Dynamic Hinges can be combined for quantity pricing.

CRL OIL DYNAMIC PATCH FITTING CLOSER WITH BACK CHECK

The CRL Oil Dynamic Patch Fitting Door Closer is an innovative patch fitting for installation on interior doors. The self-closing patch fitting is designed for installation without the need for a floor box, and is extremely quick and easy to install on to any floor. The patch fittings do not require any additional floor or overhead closing devices, yet maintain the advantages of a closing system. The closing speed is adjustable.

- Closing speed can be adjusted
- Swings in and out a full 90 degrees, with stops at 0°, +90°, and -90°.
- Also available in no-hold open option
- 100kg max door weight
- 1000mm max door width
- For 8 to 13.52mm toughened glass
- Matching top patch fittings available



SAVE 10%

FROM ONLY **£125.85***

| CAT. NO. | DESCRIPTION | FINISH | 1 | 6 |
|----------|-------------|--------|---|---|
|----------|-------------|--------|---|---|

BOTTOM PATCH FITTING WITH BACK CHECK

| | | | | |
|-----------|--------------------------------------|--|---------|---------|
| 31M100E10 | Body of patch closer, excludes cover | | £137.30 | £125.85 |
|-----------|--------------------------------------|--|---------|---------|

WITHOUT BACK CHECK

| | | | | |
|-------------|--------------------------------------|--|---------|---------|
| 31M100E10NB | Body of patch closer, excludes cover | | £141.35 | £129.60 |
|-------------|--------------------------------------|--|---------|---------|

NO HOLD OPEN OPTION

| | | | | |
|--------------|--------------------------------------|--|---------|---------|
| 31M100E10NHO | Body of patch closer, excludes cover | | £176.75 | £162.00 |
|--------------|--------------------------------------|--|---------|---------|

CLAD OPTIONS**

| | | | | |
|----------------|------------------------|--------------------|--------|--------|
| 31M100E10COVBS | Cover for patch closer | Brushed Stainless | £11.85 | £10.85 |
| 31M100E10COVPS | Cover for patch closer | Polished Stainless | £12.75 | £11.75 |
| 31M100E10COVSA | Cover for patch closer | Satin Anodised | £10.00 | £9.55 |

TOP PATCH FITTING

| | | | | |
|-----------|----------------------------|--|--------|--------|
| 31M100E20 | Matching top patch fitting | | £37.50 | £34.35 |
|-----------|----------------------------|--|--------|--------|

*Minimum order: 1 each. Price based on an order quantity of 6 (CAT. NO. 31M100E10). Price includes 10% discount. Special discount available from 1st September to 31st December 2016. All Oil Dynamic Hinges can be combined for quantity pricing.

**Clad options fit top and bottom patch fittings.



European HQ



Manchester | Charles Babbage Avenue, Kingsway Business Park, Rochdale, OL16 4NW, England

Germany



Stuttgart | Boschstrasse 7 D-74360 Ilsfeld, Germany

Denmark



Copenhagen | Stamholmen 70 Unit B, DK-2650 Hvidovre, Denmark

The Complete Collection

EUAB12UK for the Binder with the following selection of brochures:

- EUTL14 TAPER-LOC® Frameless Glass Balustrade System
- DH12UK Door Hardware & Partitioning Systems for Glass
- RS12UK Aluminium Railing & Windscreen Systems
- GA14DEUK Glass Awnings Brochure
- SDH12UK Shower Door Hardware
- OPS15DEUK Office Partition System
- CXUKDEFR15 Compact-X Sliding Door System
- CAB0UK14 Cabo Soft Close Shower Door System

EUAB12 for the Binder only

For your copy call: **00 800 0421 6144** or email: **CRL@crlaurence.co.uk**

The ring binder enables you to add new brochures as they are published.



For more information Freephone 00 800 0421 6144 (UK & Europe) | Freefax 00 800 0262 3299

