



glass

PRODUCT SHOWCASE

CREATE THE PERFECT BATHROOM

PAGE 24

Tools & Supplies
for the glass shop

9BL AND 8B SERIES ALUMINIUM BASE SHOES FOR TAPER LOC®



INNOVATIVE EXTRUDED STRUCTURE

LIGHTER, MORE AFFORDABLE AND EVEN STRONGER!

- Now 30% lighter
- 50% faster to install than alternatives
- For 17.52mm and 21.52mm laminated toughened glass

PAGE 44

NEW AND POPULAR PRODUCTS AT DISCOUNT PRICES **ORDER TODAY FROM THE GLOBAL MARKET LEADER**



VIEW ALL PRODUCT RANGES ONLINE
crlaurence.co.uk





Your CRL UK Contacts



SIMON BOOCOCK
Managing Director



STEVE BYROM
Technical Sales
steve_byrom@crlaurence.co.uk



RICHARD LAKE
UK Sales Manager
richard_lake@crlaurence.co.uk



MARK TEASDALE
Technical Sales
mark_teadale@crlaurence.co.uk



RICHARD WESLEY
Internal Sales Manager
richard_wesley@crlaurence.co.uk



STEPHEN BRAME
Internal Sales
stephen_brame@crlaurence.co.uk



PETER CASEY
Technical Sales Manager
peter_casey@crlaurence.co.uk



LYNDSEY PERRINS
Internal Sales
lyndsey_perrins@crlaurence.co.uk



LISA ZEBICHE
Marketing Manager
lisa_zebiche@crlaurence.co.uk



LOUISA HALL
Internal Sales
louisa_hall@crlaurence.co.uk



STEVEN GREGORY
Technical Sales
steven_gregory@crlaurence.co.uk



GEMMA HOWARTH
Marketing Co-ordinator
gemma_howarth@crlaurence.co.uk



EMMA MANSFIELD
Technical Sales
emma_mansfield@crlaurence.co.uk



**“We have
the world’s
largest supply
of glazing
accessories”**



Contents



Glass and Glazing Tools and Supplies

- 4-7 Glass Cutting
- 7 Glazier's Pliers
- 8 Protective Gloves and Wrist Guards
- 9 Measuring Tools
- 10-11 Belt Sander and Abrasives
- 11 Cordless Diamond Glass Saw
- 11 Scratch Polisher
- 12-14 Vacuum Lifters and Frames
- 15 Glass Transport and Handling
- 16-17 Sealants and Dispensing Tools
- 18-19 Glazing and Utility Knives
- 20 Razor Blades and Holders
- 21 Glass Setting and Framing Tools
- 22 Glazing Blocks and Tools
- 23 Glass Protection Supplies



Mirror and Shower Essentials

- 25 Mirror Mastics and Adhesives
- 25-27 Mirror Fixing Hardware
- 26 Aluminium J-Bar
- 26-27 Adhesive Tapes
- 28-29 Glass Cleaning and Protection
- 30-31 Aluminium U-Channel
- 32 Frameless Shower Hinges
- 33 Frameless Shower Knobs and Pulls
- 34-35 Frameless Shower Support Bars
- 36-37 Shower Door Wipes and Seals
- 38-39 Glass Shelf and Cabinet Hardware
- 40-42 Shower Enclosure Kits



Glass Railing Hardware

- 44-45 TAPER-LOC® Glass Railing System
- 46-48 Glass Clamps



Commercial Hardware

- 49-51 Glass Wall Partition Hardware
- 52-53 All-Glass Entrance Door Hardware
- 54-55 Oil Dynamic Hinges for Glass Doors



GLASS AND GLAZING TOOLS AND SUPPLIES



CRL TOYO® SUPERCUTTER® STRAIGHT HEAD OIL CUTTER

- Equipped with TOYO® patented Tap Wheel technology
- Precise grinding technology improves cutting
- Cemented carbide wheel and axle gives improved cutting life
- Brass or plastic straight end handles
- 140 degree hone angle

FROM ONLY
£11.00*

**SAVE
20%**

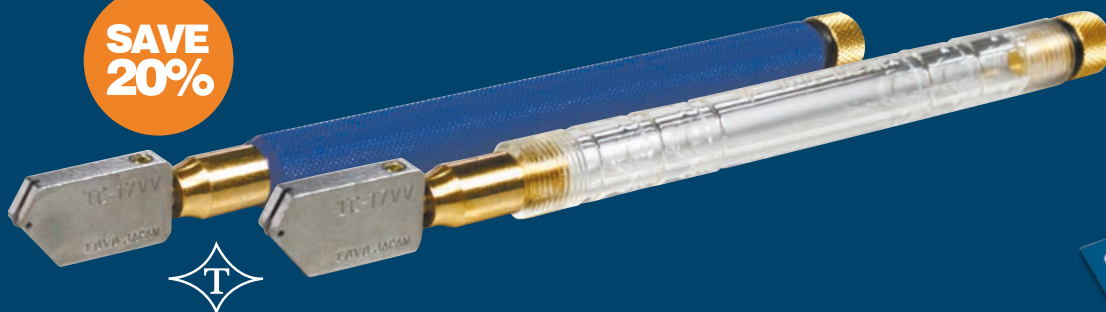

Replacement head
TC17VVH

CAT. NO.	DESCRIPTION	1	6	12
TC17VVB	Brass Handle	£13.75	£13.10	£11.25
TC17VVP	Plastic Handle	£13.40	£12.80	£11.00
TC17VVH	Replacement head	£8.95	£8.55	£7.30

* Minimum order: 1 each. Price based on an order quantity of 12 each (CAT. NO. TC17VVP).
Price includes 20% discount. Special discount available from 1st January to 30th April 2017.
Supercutter® and Tap Heads are not interchangeable. Oil type glass cutters can be combined for quantity pricing.

**EVEN MORE
GREAT PRODUCTS**

VISIT crlaurence.co.uk
and view CAT. NO. GG2014A





CRL TOYO® ORIGINAL SUPERCUTTER®

- Premium quality
- Brass or plastic straight end handles
- 140 degree hone angle carbide wheels
- For cutting 4 to 8mm glass

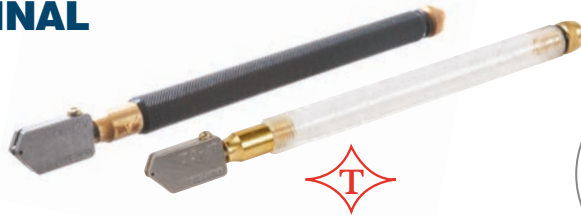

WORLD FAMOUS BEST SELLER

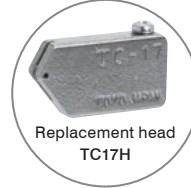

Replacement head TC17H

SAVE 20%

CAT. NO.	DESCRIPTION	1	6	12
TC17B	Brass Handle	£13.75	£13.10	£11.25
TC17P	Plastic Handle	£13.40	£12.80	£11.00
TC17H	Replacement Cutting Head - Wide	£9.40	£8.95	£7.65

*Minimum order: 1 each. Price based on an order quantity of 12 (CAT. NO. TC17P). Price includes 20% discount. Special discount available from 1st January to 30th April 2017.

FROM ONLY **£11.00***

CRL TOYO® STRAIGHT "DRY WHEEL" SUPERCUTTER®

- Black handle and wide straight head
- Moulded handle for positive grip
- 140 degree hone angle. long lasting TOYO® carbide wheel
- For cutting 4 to 6mm glass



THE ORIGINAL AND BEST



Replacement head TC20H

SAVE 20%

CAT. NO.	DESCRIPTION	1	6	12
TC20	Brass Handle	£9.30	£8.90	£7.60
TC20H	Replacement Cutting Head - Wide	£8.00	£7.65	£6.55

*Minimum order: 1 each. Price based on an order quantity of 12 (CAT. NO. TC20). Price includes 20% discount. Special discount available from 1st January to 30th April 2017.

FROM ONLY **£7.60***

CRL TOYO® COMFORT-GRIP SUPERCUTTER® WITH PATTERN HEAD

- Straight end handle
- Self-oiling
- Premium quality
- For cutting 3 to 6mm glass

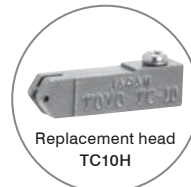

Replacement head TC10H

SAVE 20%

CAT. NO.	DESCRIPTION	1	6	12
TC1P	Comfort-Grip Supercutter	£9.90	£9.45	£8.10
TC10H	Replacement Cutting Head	£8.90	£8.50	£7.30

*Minimum order: 1 each. Price based on an order quantity of 12 (CAT. NO. TC1P). Price includes 20% discount. Special discount available from 1st January to 30th April 2017.

FROM ONLY **£8.10***

CRL TOYO® THOMAS-GRIP SUPERCUTTER® WITH PATTERN HEAD

- Pattern head model
- Self-oiling
- Unique grip
- Available in a range of coloured handles
- For cutting 3 to 6mm glass



Replacement head TC10H

SAVE 20%

CAT. NO.	DESCRIPTION	1	6	12
TC9PR	Thomas-Grip Supercutter	£11.25	£10.80	£9.20
TC10H	Replacement Cutting Head	£8.90	£8.50	£7.30

*Minimum order: 1 each. Price based on an order quantity of 12 (CAT. NO. TC9PR). Price includes 20% discount. Special discount available from 1st January to 30th April 2017.

FROM ONLY **£9.20***



CRL TOYO® TAP WHEEL™ THICK GLASS SUPERCUTTER®

- Pistol grip with standard wide head
- Smooth cutting action for glass up to 19mm thick
- Automatic self-oiling action

CAT. NO.	DESCRIPTION	1	6	12
TC600SVB	Thick Glass Supercutter® Cutter-Wide	£17.30	£16.45	£14.15
TC600HSV	Wide Replacement Head	£13.70	£13.10	£11.20

*Minimum order: 1 each. Price based on an order quantity of 12 (CAT. NO. TC600SVB). Price includes 20% discount. Special discount available from 1st January to 30th April 2017.

FROM ONLY
£14.15*



SAVE
20%



CAT. NO. TC600HSV

CRL HEAVY-DUTY 6 WHEEL GLASS CUTTER

- Best selling glass cutter in Europe
- Popular 6 wheel design for extended use life
- For cutting 3 to 10mm glass

CAT. NO.	DESCRIPTION	1	6	12	60
G100	6 Wheel Glass Cutter	£81.20	£75.75	£72.15	£68.90

*Minimum order: 1 each. Price based on an order quantity of 60.

FROM ONLY
£68.90*



CRL PRECISION CIRCLE CUTTER

- Our most popular circle cutter
- Precision action 6-wheel turret
- Vacuum cup base
- Larger models for diameters up to 1981mm available online at crlaurence.co.uk

CAT. NO.	DESCRIPTION	1
511CC	63.5mm to 610mm	£42.65
512CC	63.5mm to 813mm	£47.05

*Minimum order: 1 each. Price based on an order quantity of 1 (CAT. NO. 511CC).

FROM ONLY
£42.65*



CRL EVAPORATING VAPOURMAX 53 CUTTING FLUID

- Fast evaporating cutting fluid for flat, soft-coated, automotive and mirrored glass
- For 2 to 15mm thick glass and mirror
- Residue free finish
- Recommended for low-e

CAT. NO.	CONTENTS	1
EUW9531L	1 Litre	£7.75
EUW9535L	5 Litres	£27.85
EUW95325L	25 Litres	£118.45

*Minimum order: 1 each. Price based on an order quantity of 1 (CAT. NO. EUW9531L).

FROM ONLY
£7.75*





CRL ROUND EDGE TEMPLATE GUIDE

- Make consistent radius corners easier than ever
- Choose from 12 radii (10mm to 70mm)
- Solid plastic construction makes it economical and unbreakable
- Features four slip-resistant pads to keep the template in place during use and to reduce the risk of scratching the glass

CAT. NO.	DESCRIPTION	1
RET12	Round Edge Template Guide	£11.95

*Minimum order: 1 each. Price based on an order quantity of 1.
Price includes 10% discount. Special discount available from 1st January to 30th April 2017.

ONLY
£11.95*

SAVE
10%



CRL L-SQUARE

- Sturdy, durable and accurate
- Made to exacting specifications to ensure a right angle time after time
- Upright Thickness: 4mm
- Upright Width: 65mm

CAT. NO.	DESCRIPTION	1	10
M00555	1100mm L-Square	£30.95	£28.55
M00556	1310mm L-Square	£26.85	£24.80
M00557	1560mm L-Square	£43.65	£40.25

*Minimum order: 1 each. Price based on an order quantity of 10 (CAT. NO. M00556).

FROM ONLY
£24.80*



CRL DROP JAW GLASS BREAKING PLIERS

- Excellent forged steel pliers for glass up to 12mm thick
- One of the most popular glass tools
- Drop jaw design for superior leverage
- 216mm overall length

SAVE
10%

CAT. NO.	DESCRIPTION	1	5
RD1932	Drop Jaw Glass Break Pliers	£15.80	£15.10

*Minimum order: 1 each. Price based on an order quantity of 5.
Price includes 10% discount. Special discount available from 1st January to 30th April 2017.

FROM ONLY
£15.10*



CRL FLARED JAW GLASS PLIERS

- 25.4mm flared jaw
- Smooth grip
- 210mm overall length
- Precision machined tips

SAVE
10%

BEST SELLER

CAT. NO.	DESCRIPTION	1	5
RD1935	Flared Jaw Glass Pliers	£15.80	£15.10

*Minimum order: 1 each. Price based on an order quantity of 5.
Price includes 10% discount. Special discount available from 1st January to 30th April 2017.

FROM ONLY
£15.10*





CRL CUT RESISTANT LEVEL 5 WRIST GUARDS

- Our best value wrist guard
- Ambidextrous - can be worn on either arm
- Velcro fastening
- Durable and comfortable
- BS EN 388 X-5-X-3
- Sold by the pair

CAT. NO.	LENGTH	1	12	24
0601	152 mm	£13.05	£11.35	£10.80
06012	203 mm	£14.55	£12.65	£12.00

*Minimum order: 1 pair. Price based on an order quantity of 24 pairs (CAT. NO. 0601). Price includes 10% discount. Special discount available from 1st January to 30th April 2017.

GREAT VALUE

FROM ONLY
£10.80*
PER PAIR

BSEN388 RATED



SAVE 10%

CRL CUT-RESISTANT POWERFLEX+ KEVLAR® GLOVES

- Excellent cut resistance and grip
- Protects against cuts, punctures, and slashes
- Cut Level 5
- Tested EN388 3444
- Sold by the pair

CAT. NO.	SIZE	1	20
0625	Small	£11.25	£10.05
0626	Medium	£11.25	£10.05
0627	Large	£11.25	£10.05

*Minimum order: 1 pair. Price based on an order quantity of 20 pairs (CAT. NO. 0625). Price includes 10% discount. Special discount available from 1st January to 30th April 2017.

FROM ONLY
£10.05*
PER PAIR

BSEN388 RATED



SAVE 10%

CRL CUT-RESISTANT KEVLAR® GLOVES

- Cut Level 5
- Tested EN388 4544
- Sold by the Pair
- Come in three sizes

CAT. NO.	SIZE	1	20
0625A	Small	£8.15	£6.55
0626A	Medium	£8.15	£6.55
0627A	Large	£8.15	£6.55

*Minimum order: 1 pair. Price based on an order quantity of 20 pairs (CAT. NO. 0625A). Price includes 10% discount. Special discount available from 1st January to 30th April 2017.

FROM ONLY
£6.55*
PER PAIR

BSEN388 RATED



SAVE 10%

CRL ATLAS® CUT-RESISTANT KEVLAR® GLOVES

- Ergonomic fit as well as an outstanding grip
- The perfect glove for glass fabricators
- ANSI cut resistance: 3
- Comes in four sizes

CAT. NO.	SIZE	1
300KVS	Small	£7.85
300KVM	Medium	£7.85
300KVL	Large	£7.85
300KVXL	Extra Large	£7.85

*Minimum order: 1 pair. Price based on an order quantity of 1 pair (CAT. NO. 300KVS). Price includes 10% discount. Special discount available from 1st January to 30th April 2017.

ONLY
£7.85*
PER PAIR

SAVE 10%





CRL TAPE MEASURES

- Accurate measurements in centimeters
- Professional quality
- Positive lock button

SAVE
10%

CAT. NO.	LENGTH	WIDTH	1	6	10
0427S	5m	19mm	£13.95	-	£11.40
54819	5m	19mm	£7.55	£6.95	-
SBM5	5m	32mm	£19.70	-	-

*Minimum order: 1 each. Price based on an order quantity of 6 (CAT. NO. 54819)

FROM ONLY
£6.95*



CAT. NO. 0427S



CAT. NO. SBM5



CAT. NO. 54819

CRL GLASS GAUGE PRO

- Measures single and double glazed units
- Easy read double-sided rule with 2mm graduations
- Designed to fit around UPVC windows and doors
- Reflection device shows the thickness of each individual pane
- Specially designed ball-tip for maximum accuracy
- Manufactured from engineering grade plastic

CAT. NO.	DESCRIPTION	1	6
0471B	Glass Gauge Pro	£39.70	£36.50

*Minimum order: 1 each. Price based on an order quantity of 6.

FROM ONLY
£36.50*



CRL METRIC SCALE GLASS THICKNESS LASER

- Measures from inside of the building - no glass removal is necessary
- Calculates the thicknesses of insulating glass, laminated, bullet-resistant, and single lite float glass
- Padded carrying case and batteries included
- Provides metric measurements

CAT. NO.	DESCRIPTION	1
MG1500MM	Glass Thickness Metric Laser	£267.15

*Minimum order: 1 each. Price based on an order quantity of 1.

ONLY
£267.15*



CRL GLASS-CHEK ELITE

- Identifies laminated glass in a window
- Measures the thickness of the laminate inner-layer
- Graphical display shows profile of window
- Can identify piece of glass with Low-e coating

CAT. NO.	DESCRIPTION	1	4
GC3200	Glass-Chek Elite	£1060.60	£1016.90

*Minimum order quantity: 1 each. Price based on an order quantity of 4.

FROM ONLY
£1016.90*





CRL MAKITA® 29MM X 533MM BELT SANDER 240V

- Extremely popular portable sander for sanding notches and cut-outs
- Side handle for easy manoeuvrability • Compact and lightweight

CAT. NO.	DESCRIPTION	1
EU9031M	Belt Sander	£258.95

*Minimum order: 1 each. Price based on an order quantity of 1.
Price includes 5% discount. Special discount available from 1st January to 30th April 2017.

ONLY
£258.95*

SAVE
5%

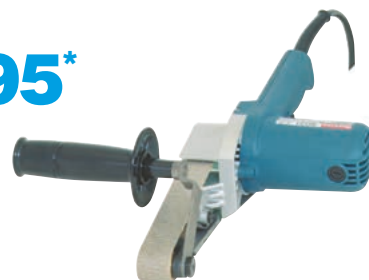

CRL 29MM X 533MM GLASS GRINDING BELTS FOR PORTABLE SANDERS

- Designed for use with the CRL EU9031M sander
- 29 x 533 mm
- Fast grinding 100% polyester backed belts for notches and cut-outs
- Belts in 12 grits from 40X to CORK
- Sold by the box

CAT. NO.	DESCRIPTION	QTY/BOX	1	5	10	20
CRL118X2140X	40 Grit	10	£8.05	£7.15	£6.50	£6.05
CRL118X2160X	60 Grit	10	£7.35	£6.50	£5.95	£5.55
CRL118X2180X	80 Grit	10	£7.05	£6.25	£5.75	£5.25
CRL118X21120X	120 Grit	10	£6.95	£6.05	£5.55	£5.15
CRL118X21180X	180 Grit	10	£6.95	£6.05	£5.55	£5.15
CRL118X21220X	220 Grit	10	£6.95	£6.05	£5.55	£5.15
CRL118X21400X	400 Grit	10	£6.95	£6.05	£5.55	£5.15
CRL118X21CORK	Cork Polishing	5	£15.95	£14.55	£13.35	£12.65

*Minimum order: 1 box. Price based on an order quantity of 20 boxes (CAT. NO. CRL118X21120X).
Price includes up to 15% discount. Special discount available from 1st January to 30th April 2017.

FROM ONLY
£5.15*
PER BOX



SAVE
UP TO
15%

CRL 100MM X 1830MM ABRASIVE BELTS FOR BOHLE BELT MACHINES

- Top quality, long lasting • Polyester wet-dry backing
- Non-directional • Sold individually

CAT. NO.	DESCRIPTION	1	20
13317K	60 Grit	£9.60	£6.75
1317BK	80 Grit	£7.05	£5.15
1317DK	100 Grit	£7.05	£5.15
1317B05K	120 Grit	£7.05	£5.15
13320K	150 Grit	£8.70	£6.10
1317B1K	180 Grit	£7.05	£5.15
1317B3K	220 Grit	£7.05	£5.15
1317B2K	400 Grit	£7.05	£5.15
1317EK	Cork Polishing	£12.65	£8.85

*Minimum order: 1 each. Price based on an order quantity of 20 (CAT. NO. 1317BK).
Price includes 10% discount. Special discount available from 1st January to 30th April 2017.

FROM ONLY
£5.15*
PER BELT

SAVE
10%

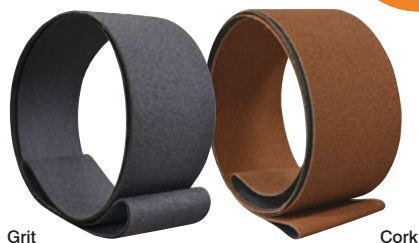

Grit

Cork

CRL 100MM X 1800MM ABRASIVE BELTS FOR GLASMEK BELT MACHINE

- Top quality, long lasting • Polyester wet-dry backing
- Non-directional • Sold individually

CAT. NO.	DESCRIPTION	1	20
13309K	60 Grit	£9.50	£6.75
13310K	80 Grit	£8.50	£6.00
1327K	120 Grit	£8.50	£6.00
13143K	180 Grit	£8.50	£6.00
1317HK	220 Grit	£8.50	£6.00
1317AK	Cork Polishing	£12.65	£10.15

*Minimum order: 1 each. Price based on an order quantity of 20 (CAT. NO. 1327K).
Price includes 10% discount. Special discount available from 1st January to 30th April 2017.

FROM ONLY
£6.00*
PER BELT

SAVE
10%

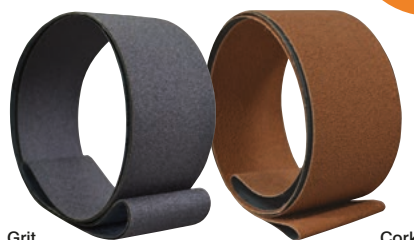

Grit

Cork





CRL DIAMOND HAND PADS

- Long-lasting diamond abrasive
- Works great on smooth or uneven surfaces
- Use wet or dry
- 57mm x 95mm pad size

CAT. NO.	COLOUR	GRIT	1
DHP60	Green	60X	£14.85
DHP120	Black	120X	£13.45
DHP220	Red	220X	£10.00
DHP400	Yellow	400X	£10.00
DHPSET	Set of above pads	Set of above pads	£134.15

*Minimum order: 1 each. Price based on an order quantity of 1 (CAT. NO. DHP400).

FROM ONLY
£10.00*



BEST SELLER

CRL MAKITA® CORDLESS DIAMOND SAW 10.8V

- Complete with battery, battery charger, diamond saw blade and water feed bottle
- Recommended replacement blade: CAT. NO. NS3B

**SAVE
5%**

ONLY
£215.15



CAT. NO.	DESCRIPTION	1
15605	Cordless diamond saw	£215.15

*Minimum order: 1 each. Price based on an order quantity of 1. Price includes 5% discount. Special discount available from 1st January to 30th April 2017.

CRL METAL BOND DIAMOND GLASS CUTTING BLADE

- Produces a clean, chip-free cut in glass and mirror
- Perfect choice for cutting notches and straight lines
- Suitable for use with CAT. NO. 15605 Diamond Saw
- 86mm diameter

**SAVE
10%**

ONLY
£27.50*



CAT. NO.	DESCRIPTION	1
NS3B	Metal bond diamond glass cutting blade	£27.50

*Minimum order: 1 each. Price based on an order quantity of 1. Price includes 10% discount. Special discount available from 1st January to 30th April 2017.

CRL HEAVY-DUTY SCRATCH POLISHER

- Polishes all types of glass, from windshields to watch crystals
- Use it hand-held or bench mounted for added stability
- Powered by a heavy-duty, double-insulated motor
- Sure grip handles on each end of the tool assembly provide control
- Includes felt wheel (CAT. NO. 1322) and 1kg of Cerium Oxide (CAT.NO. 1222A)

**SAVE
10%**

ONLY
£697.10*



CAT. NO.	DESCRIPTION	1
1520	230V Scratch Polisher	£697.10
1520A	110V Scratch Polisher	£697.10

*Minimum order: 1 each. Price based on an order quantity of 1 (CAT. NO. 1520). Price includes 10% discount. Special discount available from 1st January to 30th April 2017.



CRL S338 SURE-GRIP 203MM VACUUM LIFTER

- Greatest lifting capacity of any 203mm pump activated vacuum lifter
- One hand pump and attachment for safety when needed
- Superior “press-and-pump” attachment feature
- Built-in vacuum loss indicator
- Soft contoured sure-grip handle for comfort
- Sturdy moulded carrying case

FROM ONLY £32.40*

CAT. NO.	DESCRIPTION	1	4	10
S338	Vacuum Lifter	£34.60	£33.55	£32.40

*Minimum order: 1 each. Price based on an order quantity of 10.



112KG LIFTING CAPACITY

Safety factor 2:1

CONVENIENT VACUUM INDICATOR



SUPERIOR COMFORT AND GRIP



FAST RELEASE





CRL PUMP-ACTION VACUUM LIFTER FOR FLAT SURFACES

- 203mm diameter pad
- Heavy-duty stainless steel handle
- Fast attachment on smooth, non-porous flat surfaces
- Can be re-pumped without losing remaining vacuum
- Tough ABS plunger with red-line indicator
- Full pad face contact when pumped reduces distortion
- Wide release valve lever with safety guard permits quick and complete release
- 57kg lifting capacity

CAT. NO.	DESCRIPTION	1	4
S7950	203mm Pump-Action Vacuum Lifter	£46.15	£41.85

*Minimum order: 1 each. Price based on an order quantity of 4.
Price includes 10% discount. Special discount available from 1st January to 30th April 2017.

FROM ONLY
£41.85*



**SAVE
10%**



CRL PUMP-ACTION VACUUM LIFTER FOR CURVED GLASS

- 203mm diameter pad
- Designed primarily for lifting curved architectural glass
- Excellent also for thin, flexible materials
- Red-line indicator warns user of any vacuum loss
- Moulded carrying case
- 56kg lifting capacity

CAT. NO.	DESCRIPTION	1	4	10
S109	Pump-Action Vacuum Lifter	£41.20	£38.85	£36.50

*Minimum order: 1 each. Price based on an order quantity of 10.

FROM ONLY
£36.50*



CRL PUMP-ACTION VACUUM LIFTER

- 203mm diameter pad
- Heavy-duty 5mm thick ABS handle resists bending, especially during heavy lifts
- Fast, safe attachment to smooth, non-porous flat surfaces
- Four extra mounting points make it easy to attach to metal lifting frames, jigs, and our vacuum ratchet tensioning kit
- 56kg lifting capacity

CAT. NO.	DESCRIPTION	1	4	10
S108	Pump-Action Vacuum Lifter	£34.75	£33.60	£32.40

*Minimum order: 1 each. Price based on an order quantity of 10.

FROM ONLY
£32.40*



CRL ALUMINIUM FRAME VACUUM LIFTERS

- Sturdily built traditional design aluminium frame
- Each suction pad operates separately
- 114mm diameter suction pads

**SAVE
10%**

CAT. NO.	DESCRIPTION	LIFTING CAPACITY	1	6
05061	1 Vacuum Pad	30kg	£30.35	£27.05
05062	2 Vacuum Pads	60kg	£34.55	£30.65
05063	3 Vacuum Pads	100kg	£41.60	£35.35

*Minimum order: 1 each. Price based on an order quantity of 6 (CAT. NO. 05061).
Price includes 10% discount. Special discount available from 1st January to 30th April 2017.

FROM ONLY
£27.05*





CRL WOOD'S POWR-GRIP® ABS HANDLE VACUUM CUP

- 203mm diameter pad
- Lightweight, heavy-duty ABS handle
- Check valve allows re-pumping without loss of remaining vacuum
- Release valve lever permits quick and complete release
- Fast attachment on smooth, non-porous flat surfaces
- Red-line indicator warns user of any vacuum loss
- Supplied with protective carrying case
- 57kg lifting capacity

CAT. NO.	DESCRIPTION	1
N4000	ABS Handle Vacuum Cup	£38.20

*Minimum order: 1 each. Price based on an order quantity of 1.

ONLY
£38.20*



Wood's
Power-Grip

CE

CRL WOOD'S POWR-GRIP® METAL HANDLE VACUUM CUP

- 203mm diameter pad
- Durable metal handle
- Check valve allows re-pumping without loss of remaining vacuum
- Fast attachment on smooth, non-porous flat surfaces
- Red-line indicator warns user of any vacuum loss
- Release valve lever permits quick, complete release
- 57kg lifting capacity

CAT. NO.	DESCRIPTION	1
N4950	Metal Handle Vacuum Cup	£49.80

*Minimum order: 1 each. Price based on an order quantity of 1.
Price includes 10% discount. Special discount available from 1st January to 30th April 2017.

ONLY
£49.80*



Wood's
Power-Grip

CE

CRL WOOD'S POWR-GRIP® SINGLE CHANNEL D.C. VACUUM LIFTING FRAME

- 320kg lifting capacity
- Four 280mm diameter lipped pads
- 180° edgewise rotation
- 90° tilt, vertical to flat
- 12V DC

Get specifications online at crlaurence.co.uk

CAT. NO.	DESCRIPTION	1
EUP11104DCO	Single Channel D.C. Vacuum Lifting Frame	£2518.00

*Minimum order: 1 each. Price based on an order quantity of 1.
Price includes 10% discount. Special discount available from 1st January to 30th April 2017.

ONLY
£2518.00*



Wood's
Power-Grip

CE

CRL WOOD'S POWR-GRIP® D.C. TILT ROTATOR VACUUM LIFTING FRAMES

- Cord-free operation with on-board gel cell battery
- 280mm diameter lipped pads
- Multiple configurations all from the same unit
- Full 360° rotation with tilt from any position
- 12V DC

Get specifications online at crlaurence.co.uk

CAT. NO.	DESCRIPTION	1
EUMRT411LDC	D.C. Manual Rotator/Tiltter - 4 pads	£3415.00
EUMRTA811LDC2	D.C. Quadra Tilt Rotator 1100 Series - 8 pads	£4792.00

*Minimum order: 1 each. Price based on an order quantity of 1 (CAT. NO. EUMRT411LDC).
Price includes 10% discount. Special discount available from 1st January to 30th April 2017.

FROM ONLY
£3415.00*



Wood's
Power-Grip

CE



Ask about our annual service for lifting frames





CRL GLASSTRAX GLASS DOLLY

- Safe glass transport with large 272kg capacity
- Self clamping action locks loads up to 50.8mm thick
- One person can load and manoeuvre

SAVE 10%

FROM ONLY **£355.75***

BEST SELLER



VIEW A DEMO

CAT. NO.	DESCRIPTION	1	4
GT02	Glass Dolly	£390.80	£355.75

*Minimum order: 1 each. Price based on an order quantity of 4. Price includes 10% discount. Special discount available from 1st January to 30th April 2017.

CRL ALL TERRAIN DOLLY

- Exclusive to CRL
- Terrific for moving heavy glass panels around the job site
- Goes where other glass dollies won't
- Built-In 203mm Wood's POWR-Grip® Vacuum Cup
- Includes a set of our RB200 Roller Blocks
- 181kg load capacity

SAVE 10%

ONLY **£422.50***



Included

CAT. NO.	DESCRIPTION	1
ATD1	All Terrain Dolly	£422.50

*Minimum order: 1 each. Price based on an order quantity of 1. Price includes 10% discount. Special discount available from 1st January to 30th April 2017.

CRL ROLLER BLOCKS

- Roller design lets you rotate heavy glass panels with ease
- Turn them over to use as resting blocks
- Rubber base ensures traction

SAVE 10%

ONLY **£40.50***
PER PAIR



CAT. NO.	DESCRIPTION	1
RB200	Roller Blocks	£40.50

*Minimum order: 1 pair. Price based on an order quantity of 1 pair. Price includes 10% discount. Special discount available from 1st January to 30th April 2017.

CRL RATCHET TENSIONING KIT WITH TWO VACUUM LIFTERS

- Pulls with tremendous force
- Ideal for countertops, marble, granite, flooring, mirrors and glass
- Comes with two 203mm vacuum lifters
- Uses S108 vacuum lifter mounting points
- Carrying capacity is 147kg

SAVE 10%

ONLY **£120.35***



NOTE: S108 vacuum lifters are also sold separately on page 13.

CAT. NO.	DESCRIPTION	1
G0284	Ratchet Tensioning Kit	£120.35

*Minimum order: 1 each. Price based on an order quantity of 1. Price includes 10% discount. Special discount available from 1st January to 30th April 2017.



CRL NEUTRAL CURE LOW MODULUS SILICONE

- Low odour, neutral cure formula
- Compatible with insulating glass glazing
- Excellent adhesion to most surfaces
- Low modulus
- High grade formula - low shrinkage
- 300ml cartridge, 12 per case
- Special countertop display box
- Conforms to ISO 11600

CAT. NO.	COLOUR	1	12	120	240
EURTV408C	Clear	£2.17	£1.97	£1.87	£1.77
EURTV408W	White	£2.17	£1.97	£1.87	£1.77
EURTV408BL	Black	£2.17	£1.97	£1.87	£1.77
EURTV408G	Grey	£2.17	£1.97	£1.87	£1.77
EURTV408BR	Brown	£2.17	£1.97	£1.87	£1.77
EURTV408A	Anthracite	NEW!	£2.17	£1.97	£1.87
EURTV408R	Rosewood	NEW!	£2.17	£1.97	£1.87

*Minimum order: 1 each. Price based on an order quantity of 240 (CAT. NO. EURTV408C).



FROM ONLY
£1.77*

BEST SELLER

THE PROFESSIONALS' CHOICE

NOW AVAILABLE IN 7 COLOURS



CRL CRYSTAL CLEAR SILICONE

- High clarity when cured
- Applications include shower enclosures and speciality glass assemblies
- 310ml cartridge
- 12 per case
- Special countertop display box

CAT. NO.	COLOUR	1	12	120	240
EUCCS	Crystal Clear	£2.30	£2.15	£2.10	£2.05

*Minimum order: 1 each. Price based on an order quantity of 240.

FROM ONLY
£2.05*



CRL SHOWER SEALANT

- Acetic cure formula
- Plastic cartridges with screw-on nozzles
- High modulus
- 300ml cartridge
- 12 per case
- Special countertop display box

CAT. NO.	COLOUR	1	12	120	240
EU33SC	Clear	£1.72	£1.52	£1.47	£1.42

*Minimum order: 1 each. Price based on an order quantity of 240.

FROM ONLY
£1.42*



CRL COATED GLASS SEALANTS

- High quality, professional and universal paintable sealant
- Used for the sealing of connecting joints and glazing systems
- Conforms with Pilkington Activ and Saint Gobain Bio Clean
- Resistant to weather, UV, water, and fungus
- 290 ml cartridge
- 12 per case

CAT. NO.	COLOUR	1	12	120	240
EUCGSBL	Black	£4.60	£4.30	£4.20	£4.10
EUCGSBR	Brown	£4.60	£4.30	£4.20	£4.10
EUCGSG	Grey	£4.60	£4.30	£4.20	£4.10
EUCGSW	White	£4.60	£4.30	£4.20	£4.10

*Minimum order: 1 each. Price based on an order quantity of 240 (CAT. NO. EUCGSBL).

FROM ONLY
£4.10*



THE PROFESSIONALS' CHOICE





CRL STANDARD SMOOTH ROD CAULKING GUN

- Our best seller is also a great value
- Thumb pressure release button
- Perfect for low viscosity materials

**MORE
OPTIONS
AVAILABLE
ONLINE**

FROM ONLY
£2.65*



CAT. NO.	DESCRIPTION	1	12
ER3	Standard Smooth Rod Caulking Gun	£2.95	£2.65

*Minimum order: 1 each. Price based on an order quantity of 12.

CRL 12:1 RATIO STRAP FRAME CAULKING GUN

- Holds standard caulking cartridges
- Best choice for low to medium viscosity materials
- Instant pressure release to prevent run-on

**MORE
OPTIONS
AVAILABLE
ONLINE**

FROM ONLY
£12.60*



**SAVE
10%**

CAT. NO.	DESCRIPTION	1	12
GA1203	12:1 Ratio Strap Frame Caulking Gun	£13.70	£12.60

*Minimum order: 1 each. Price based on an order quantity of 12.
Price includes 10% discount. Special discount available from 1st January to 30th April 2017.

CRL E.Z.D. GLAZER DE-GLAZING TOOL

- Aids in the de-glazing of glass installed with silicone, foam tapes, butyl tapes, and other flexible materials
- Blade lays flat on the glass and slides into the glazing pocket
- Extremely simple-to-use

FROM ONLY
£39.20*

**SAVE
10%**

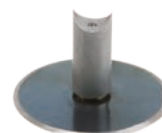

CAT. NO. EZ1022
Replacement blade

CAT. NO.	DESCRIPTION	1	6
EZ1010	E.Z.D. Glazer De-glazing Tool	£42.30	£39.20
EZ1022	Replacement Blade	£19.05	-

*Minimum order: 1 each. Price based on an order quantity of 6 (CAT. NO. EZ1010).
Price includes 10% discount. Special discount available from 1st January to 30th April 2017.

CRL PUTTY KNIVES

- Large soft-grip handle
- High carbon steel blade
- Several blade widths to choose from
- Economically priced

**SAVE
10%**

FROM ONLY
£3.25*



CAT. NO.	DESCRIPTION	WIDTH	1	12
HW033	Flexible	38mm	£3.65	£3.25
HW034	Flexible	51mm	£3.80	£3.45
HW035	Flexible	76mm	£4.45	£4.00
HW036	Flexible	102mm	£4.85	£4.35
HW039	Stiff	76mm	£4.45	£4.00

*Minimum order: 1 each. Price based on an order quantity of 12 (CAT. NO. HW033).
Price includes 10% discount. Special discount available from 1st January to 30th April 2017.



CRL SCRAPE 'N' PRY BAR

- Multi-purpose tool made of hardened, tempered steel
- Chisel ground edges
- Length: 254mm
- Width: 44.5mm

**SAVE
10%****FROM ONLY
£5.05***

CAT. NO.	DESCRIPTION	1	6
4050	Scrape 'N' Pry Bar	£5.50	£5.05

*Minimum order: 1 each. Price based on an order quantity of 6.
Price includes 10% discount. Special discount available from 1st January to 30th April 2017.

CRL 8-IN-1 PAINTER'S TOOL

- Multi purpose tool
- Comfort grip handle
- Overall length: 232mm
- Blade width: 76mm

**SAVE
10%****FROM ONLY
£3.65***

CAT. NO.	DESCRIPTION	1	6
HW048	8-in-1 Painter's Tool	£4.85	£3.65

*Minimum order: 1 each. Price based on an order quantity of 6.
Price includes 10% discount. Special discount available from 1st January to 30th April 2017.

CRL PUTTY CHISEL

- Made from high-grade carbon steel for strength and longevity
- Overall length: 210mm
- Blade width: 38mm

**SAVE
10%****FROM ONLY
£6.95***

CAT. NO.	DESCRIPTION	1	12
0704	Putty Chisel	£8.15	£6.95

*Minimum order: 1 each. Price based on an order quantity of 12.
Price includes 10% discount. Special discount available from 1st January to 30th April 2017.

CRL STIFF PUTTY KNIFE

- High quality putty knife
- Blade length: 110mm
- Width: 26mm

**SAVE
10%****ONLY
£10.35***

CAT. NO.	DESCRIPTION	1
0702	Stiff Putty Knife	£10.35

*Minimum order: 1 each. Price based on an order quantity of 1.
Price includes 10% discount. Special discount available from 1st January to 30th April 2017.





CRL OLFA® HEAVY-DUTY RETRACTABLE BLADE KNIFE

- All-Purpose knife with comfortable rubber grip
- Locking thumb screw to adjust blade length
- Uses replacement blades LB10B, LB50B, and LS0L

SAVE 10%

FROM ONLY **£6.35***



CAT. NO.	DESCRIPTION	1	6
L2K	Heavy-Duty Retractable Blade Knife	£6.85	£6.35

*Minimum order: 1 each. Price based on an order quantity of 6. Price includes 10% discount. Special discount available from 1st January to 30th April 2017.

CRL REPLACEMENT BREAKAWAY BLADES

- Fits CRL Olfa® heavy-duty retractable blade knife L2K
- Width : 18mm
- 50 per pack

SAVE 10%

FROM ONLY **£8.40***
PER PACK



CAT. NO.	DESCRIPTION	1	6
LB50B	Replacement Breakaway Blades	£8.90	£8.40

*Minimum order: 1 pack. Price based on an order quantity of 6 packs. Price includes 10% discount. Special discount available from 1st January to 30th April 2017.

CRL STANLEY® HEAVY-DUTY RETRACTABLE BLADE UTILITY KNIFE

- Industrial quality
- Retractable blade
- Features a five-position slide and heavy-duty metal body

SAVE 10%

FROM ONLY **£4.90***



CAT. NO.	DESCRIPTION	1	6
99	Heavy-Duty Retractable Blade Knife	£5.25	£4.90

*Minimum order: 1 each. Price based on an order quantity of 6. Price includes 10% discount. Special discount available from 1st January to 30th April 2017.

CRL HEAVY-DUTY UTILITY KNIFE BLADES

- Fits CRL heavy-duty retractable blade knife 99
- 100 per box

SAVE 10%

ONLY **£4.05***
PER BOX



CAT. NO.	DESCRIPTION	1	20
14171	Heavy-duty Utility Knife Blades	£4.95	£4.05

*Minimum order: 1 box. Price based on an order quantity of 20 boxes. Price includes 10% discount. Special discount available from 1st January to 30th April 2017.



CRL RAZOR BLADE HOLDER AND SCRAPER

- Safely holds single edge metal razor blades
- Comfortable handle for a sure grip
- Compatible with 51S and KKB12 razor blades

SAVE
10%

ONLY
£5.25*



BEST SELLER

CAT. NO.	DESCRIPTION	1
RS65	Razor Blade Holder and Scraper	£5.25

*Minimum order: 1 each. Price based on an order quantity of 1.
Price includes 10% discount. Special discount available from 1st January to 30th April 2017.

CRL SINGLE EDGE RAZOR BLADES

- Our most popular single edge blade
- Precision honed, surgical steel edges
- Individually wrapped to protect the edge
- Multiple uses
- 100 per box

FROM ONLY
£2.89*
PER HUNDRED



BEST SELLER

PRICES PER BOX OF 100 BLADES

CAT. NO.	DESCRIPTION	100	500	1000	5000	10000
51S	Single Edge Razor Blades	£3.65	£3.47	£3.25	£3.06	£2.89
KKB12	Heavy-Duty Razor Blades	£4.33	£3.98	£3.87	£3.80	-

*Minimum order: 100 each. Price based on an order quantity of 10,000 (CAT. NO. 51S).

CRL RAZOR BLADE HOLDER AND WINDOW SCRAPER

- Safely holds all single edge metal razor blades
- Simple thumb slide to safely conceal blade when not in use
- Compatible with our CAT. NO.'s 51S and 1409 single edge razor blades

SAVE
10%

FROM ONLY
£1.10*

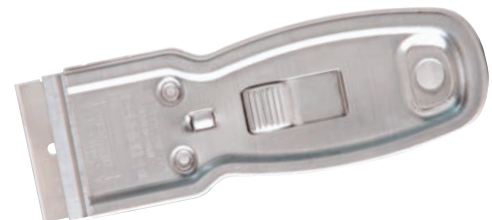

CAT. NO.	DESCRIPTION	1	12	36
3223	Razor Blade Holder and Window Scraper	£1.35	£1.15	£1.10

*Minimum order: 1 each. Price based on an order quantity of 36.
Price includes 10% discount. Special discount available from 1st January to 30th April 2017.

CRL SINGLE EDGE RAZOR BLADES

- Deliver durability along with an exact quality cut
- Each blade is individually wrapped to protect the edge until you are ready to use
- 100 per box
- Compatible with our CAT. NO. 3223 holder and scraper

FROM ONLY
£4.60*
PER HUNDRED



PRICES PER BOX OF 100 BLADES

CAT. NO.	DESCRIPTION	100	500	1000	5000	10000
1409	Single Edge Razor Blades	£5.60	£5.40	£5.10	£4.80	£4.60

*Minimum order: 100 each. Price based on an order quantity of 10,000.





CRL PUSH POINTS

- Our most popular push points
- Packages in convenient display boxes for over-the-counter sales
- Available in bulk container or retail display

CAT. NO.	DESCRIPTION	1	5	10
30	Retail display of 12 packages	£10.20	£9.30	£8.55
31B	0.45kg bulk container	£6.75	£6.15	£5.65

*Minimum order: 1 each. Price based on an order quantity of 10 (CAT. NO. 31B).

FROM ONLY
£5.65



CRL LIGHTWEIGHT GLAZIER'S HAMMER

- Ideal for glazing and picture framing
- 295mm laquered ashwood handle
- Forged steel hardened and fully polished head with stabilizing supports
- Overall Length: 310mm

CAT. NO.	DESCRIPTION	1	5
0220	Glazier's Hammer	£18.55	£17.10

*Minimum order: 1 each. Price based on an order quantity of 5.

FROM ONLY
£17.10*



CRL PLATE GLASS LIFTING TOOL

- For lifting and setting plate glass
- Helps prevent lifting related injuries
- Aids in storefront window installation
- Width: 273mm

SAVE
10%

CAT. NO.	DESCRIPTION	1
PGL11	Plate Glass Lifting Tool	£5.75

*Minimum order: 1 each. Price based on an order quantity of 1.
Price includes 10% discount. Special discount available from 1st January to 30th April 2017.

ONLY
£5.75*

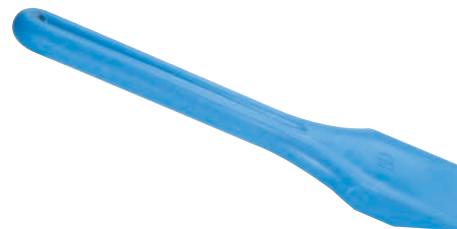

CRL BLOCK LEVERS

- Handy tool for all glazing jobs
- Choose either the all wood or the strong wooden handle with hard-wearing plastic head block lever

CAT. NO.	DESCRIPTION	1	10
0735	Plastic Head Block Lever	£3.80	£3.25
0736	All Wood Block Lever	£1.70	£1.60

*Minimum order: 1 each. Price based on an order quantity of 10 (CAT. NO. 0736).

FROM ONLY
£1.60*





CRL STANDARD VINYL ROLLER TOOL

- Ideal for inserting all types of flat spline and roll-in gaskets
- Made from solid aluminium with a hard coat anodised finish
- Knurl diamond grip and a ball bearing wheel

SAVE
10%

FROM ONLY
£6.80*



CAT. NO.	LENGTH	1	6
VR04	279mm	£7.50	£6.80

*Minimum order: 1 each. Price based on an order quantity of 6.
Price includes 10% discount. Special discount available from 1st January to 30th April 2017.

CRL PLASTIC GLAZING BLOCKS

- Colour coded for easy selection by size
- Polypropylene material is extremely durable
- 1000 of one size per box

FROM ONLY
£25.45*
PER BOX OF 1000

CAT. NO.	SIZE	COLOUR	1	3	5
KK201	100 x 20 x 1mm	White	£29.75	£27.45	£25.45
KK202	100 x 20 x 2mm	Blue	£32.00	£29.55	£27.45
KK203	100 x 20 x 3mm	Red	£33.75	£31.20	£29.00
KK204	100 x 20 x 4mm	Yellow	£35.25	£32.55	£30.25
KK221	100 x 22 x 1mm	White	£32.65	£30.15	£28.00
KK222	100 x 22 x 2mm	Blue	£34.10	£31.50	£29.25
KK223	100 x 22 x 3mm	Red	£35.55	£32.85	£30.55
KK224	100 x 22 x 4mm	Yellow	£38.05	£35.10	£32.60
KK241	100 x 24 x 1mm	White	£35.90	£33.15	£30.75
KK242	100 x 24 x 2mm	Blue	£36.55	£33.75	£31.35
KK243	100 x 24 x 3mm	Red	£38.05	£35.10	£32.60
KK244	100 x 24 x 4mm	Yellow	£39.40	£36.10	£33.35

*Minimum order quantity: 1 box. Price based on an order quantity of 5 boxes (CAT. NO. KK201).



CRL WOOD GLAZING BLOCKS

- Colour coded for easy selection by size
- Multi-purpose glazing blocks made of impregnated wood
- 100 per package

FROM ONLY
£2.10*
PER PACK OF 100

CAT. NO.	SIZE	COLOUR	1
KH202	80 x 20 x 2mm	Red	£2.10
KH203	80 x 20 x 3mm	Green	£2.25
KH204	80 x 20 x 4mm	Yellow	£2.75
KH205	80 x 20 x 5mm	Blue	£3.15
KH206	80 x 20 x 6mm	Black	£3.45

*Minimum order quantity: 1 pack. Price based on an order quantity of 1 pack (CAT. NO. KH202).





CRL BLUE TRANSPORT PADS

- Medium density
- Low-tack, pressure sensitive adhesive
- Leaves no adhesive residue or ghosting marks

**SAVE
10%**

CAT. NO.	SIZE	QUANTITY	1	5
1407E	23 x 18 x 4mm	1,000 pads per roll	£5.55	£5.00
1407LOG10	24 x 19 x 4mm	10,000 pads per roll	£52.00	£42.65
1407LOG20	21 x 18 x 4mm	20,000 pads per roll	£85.05	£80.10

*Minimum order quantity: 1 roll. Price based on an order quantity of 5 rolls (CAT. NO. 1407E)
Price includes 10% discount. Special discount available from 1st January to 30th April 2017.

FROM ONLY
£5.00*
PER ROLL

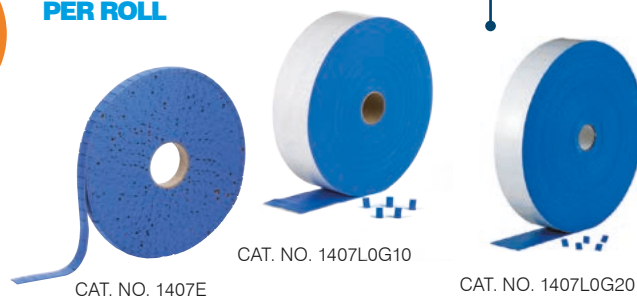
BEST SELLER

CRL CLEAR PROTECTIVE BUMPADS

- Use on cabinet doors, desk tops, and glass table tops
- Also available in brown and white
- Protect glass tops from scratching
- Simply peel and stick
- Bottom diameter 12.7mm; top diameter: 11.1mm; height: 3.2mm

CAT. NO.	QUANTITY	1	3
CB1PK200	200 per pack	£7.15	-
CB1PK	1000 per pack	£34.95	£31.55

*Minimum order: 1 pack. Price based on an order quantity of 1 pack (CAT. NO. CB1PK200).
Price includes 10% discount. Special discount available from 1st January to 30th April 2017.

FROM ONLY
£7.15*
PER PACK

MULTI-USAGE**SAVE
10%**

CRL VITROBOR SURFACE PROTECTION FILM

- 40 micron green film
- Adhesive free
- No residue
- Static hold
- Prevents scratches
- Tested to BS2782

CAT. NO.	ROLL SIZE	1	10
21112G	600mm x 920m	£88.50	£78.70
21113G	1000mm x 920m	£147.55	£131.15
21114G	1200mm x 920m	£177.05	£157.40
21115G	1500mm x 920m	£221.30	£196.75
21120G	1800mm x 920m	£267.35	£238.25
21121G	2100mm x 920m	£294.35	£261.75

*Minimum order quantity: 1 roll. Price based on an order quantity of 10 rolls (CAT. NO. 21112G)
Price includes 10% discount. Special discount available from 1st January to 30th April 2017.

FROM ONLY
£78.70*
PER ROLL

**SAVE
10%**

CRL CORNER PROTECTORS

- Designed to protect glass and mirror edges during shipping, handling or storing
- Will not scratch or damage glass or mirror surfaces, and help protect large cut-offs from breakage or becoming scrap
- Protectors are reusable, they simply slide on and off
- 250 per box

CAT. NO.	GLASS THICKNESS	1
1464004B	4mm	£17.00
1464006B	6mm	£17.00
1464008B	8mm	£17.85
1464010B	10mm	£19.95

*Minimum order: 1 box. Price based on an order quantity of 1 box (CAT. NO. 1464006B).
Price includes 10% discount. Special discount available from 1st January to 30th April 2017.

FROM ONLY
£17.00*
PER BOX

**SAVE
10%**



MIRROR AND SHOWER ESSENTIALS

CREATE THE PERFECT BATHROOM

CRL. the world's largest supplier of frameless shower products

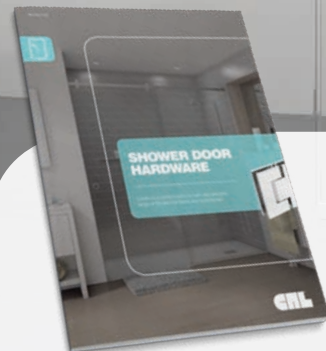

See the full range

Get your Shower Door Hardware brochure today

CAT. NO. SDH17UK





CRL eg310 evergrip™ MIRROR ADHESIVE

- Extra fast grab mirror adhesive
- Extra strong holding capacity
- Fast curing, with skin formation in about five minutes
- Adhesion to almost all surfaces
- Low VOC, solvent free, low odour
- 310ml cartridge

FROM ONLY **£1.99***

BEST SELLER

SAVE 10%



CAT. NO.	DESCRIPTION	12	60	120	240
EG310	Mirror Adhesive	£2.30	£2.15	£2.05	£1.99

*Minimum order: 12 each. Price based on an order quantity of 240 each. Price includes 10% discount. Special discount available from 1st January to 30th April 2017.

CRL eg310ULTRA COMPLETE ADHESIVE

- MS polymer based
- Neutral curing and odourless
- Cures with atmospheric moisture
- Super-fast bonding of mirrors, glass, wood, composite panels, and metal, to a range of substrates
- Free of silicone and isocyanides
- 290ml cartridge

FROM ONLY **£4.15***

HIGH PERFORMANCE GRIP AND GRAB ADHESIVE

SAVE 10%

MULTI PURPOSE ADHESIVE



CAT. NO.	DESCRIPTION	1	60	120	240
EG310ULTRA	Complete Adhesive	£4.79	£4.55	£4.35	£4.15

*Minimum order: 1 each. Price based on an order quantity of 240 each. Price includes 10% discount. Special discount available from 1st January to 30th April 2017.

CRL E-Z MOUNT MIRROR CLIP SET

- Our best-selling mirror clip sets are the fast and secure way to hang mirrors
- For 4mm and 6mm glass
- Made of nickel plated steel
- Upper clips - have unique, spring loaded flanges. You just expand these clips during installation, it's quick and easy!
- Lower clips - always remain stationary and have a 7.9mm channel space. These clips are not spring-loaded, and are designed to carry the mirror's weight

FROM ONLY **£1.35***



CAT. NO.	DESCRIPTION	1	3	5	10	20	50	100	250	1000
655	Set of 4 Clips	£1.82	-	-	-	-	£1.72	£1.60	£1.49	£1.35
50655B	Bulk carton of 50	£65.75	£61.15	£58.30	£55.05	£51.05	-	-	-	-

*Minimum order: 1 set. Price based on an order quantity of 1000 sets (CAT. NO. 655).

CRL HEATED MIRROR PADS

- Prevents mirror misting
- Simple installation
- Applied to back of mirror
- Made in Europe
- 240 Volts

FROM ONLY **£14.40***

HIGH PERFORMANCE

SAVE 10%



CAT. NO.	SIZE	1	10	100
7020MP	584mm x 274mm	£18.15	£15.50	£14.40
7030MP	524mm x 520mm	£26.85	£22.70	£21.10
7035MP	785mm x 524mm	£33.80	£28.60	£26.60
7040MP	1040mm x 524mm	£39.80	£33.70	£31.30
7050MP	1505mm x 524mm	£57.60	£47.90	£45.20

*Minimum order: 1 each. Price based on an order quantity of 100 (CAT. NO. 7020MP). Price includes 10% discount. Special discount available from 1st January to 30th April 2017.



CRL EM SERIES MIRROR MOUNTING SET

- Magnet mirror mounting set including eccentric discs, mirror-adhesive magnets, mirror plates, self-adhesive pads, screw, and wall plugs
- Easy installation
- Fixings hidden from sight
- Suitable for mirror surfaces up to 0.8m², 1.6m², and 2.6m²
- Suitable for wet rooms

Each set includes: P19EM08/P19EM16: 2 each eccentric discs. 2 each mirror-adhesive magnets. 2 each mirror plates. P19EM26: 3 each eccentric discs. 2 each mirror-adhesive magnets. 3 each mirror plates.

CAT. NO.	DESCRIPTION	1	24	48
P19EM08	0.8m ² Mirror Surface	£3.90	£3.70	£3.55
P19EM16	1.6m ² Mirror Surface	£4.65	£4.40	£4.25
P19EM26	2.6m ² Mirror Surface	£5.80	£5.50	£5.30

*Minimum order: 1 set. Price based on an order quantity of 48 sets (CAT. NO. P19EM08). Price includes 10% discount. Special discount available from 1st January to 30th April 2017.

FROM ONLY
£3.55*
PER SET

SAVE
10%

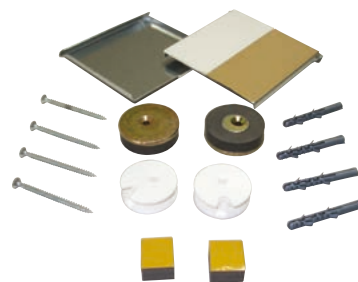

CRL DEEP NOSE ALUMINIUM J-BAR FOR MIRROR

- Punched and slotted for easier installation
- 3.66m stock lengths
- 40 per case

CAT. NO.	FINISH	1	10	40	80	120
D645BA	Brite Anodised	£19.10	£16.95	£15.30	£13.85	£12.65
D645A	Satin Anodised	£12.65	£11.25	£10.10	£9.20	£8.40
D645BN	Brushed Nickel	£27.30	£24.40	£21.95	£19.90	£18.30

*Minimum order: 1 each. Price based on an order quantity of 120 (CAT. NO. D645A). Price includes 10% discount. Special discount available from 1st January to 30th April 2017.

FROM ONLY
£8.40*
PER LENGTH

SAVE
10%

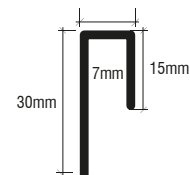

CRL STANDARD ALUMINIUM J-BAR FOR MIRROR

- Punched and slotted for easier installation
- 3.66m stock lengths
- 50 per case

CAT. NO.	FINISH	1	10	50	100	150
D636BA	Brite Anodised	£16.45	£14.60	£13.15	£11.95	£11.05
D636A	Satin Anodised	£10.80	£9.55	£8.70	£7.85	£7.30
D636BN	Brushed Nickel	£22.80	£20.25	£18.30	£16.55	£15.15

*Minimum order: 1 each. Price based on an order quantity of 150 (CAT. NO. D636A). Price includes 10% discount. Special discount available from 1st January to 30th April 2017.

FROM ONLY
£7.30*
PER LENGTH

SAVE
10%

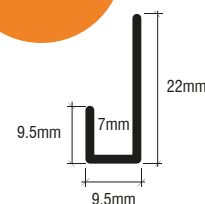

CRL ALL-PURPOSE FOAM MOUNTING TAPE

- Highly adhesive and flexible
- Conforms to a wide variety of surfaces
- Just peel and apply
- Excellent for mirrors, glass, metals, plastics and other surfaces
- Ideal for use in combination with mirror adhesive

CAT. NO.	LENGTH	WIDTH	THICKNESS	ROLLS / CASE	1	16	23	80	115
CRL211612	33m	12.5m	1.6mm	23	£5.80	-	£5.15	-	£4.95
CRL211634	33m	19m	1.6mm	16	£7.35	£6.60	-	£6.30	-
CRL210812	15m	12.5m	3mm	23	£3.85	-	£3.45	-	£3.30
CRL210834	15m	19m	3mm	16	£5.25	£4.75	-	£4.60	-

*Minimum order: 1 roll. Price based on an order quantity of 5 cases (CAT. NO. CRL210812). Price includes 10% discount. Special discount available from 1st January to 30th April 2017.

FROM ONLY
£3.30*
PER ROLL

SAVE
10%





CRL TRANSPARENT ACRYLIC HI-BOND ADHESIVE TAPE

- Speciality tape for the fabrication of shower enclosures
- Excellent for use with clear polycarbonates, seals, and wipes
- Instant pressure sensitive bonding; full strength in 72 hours

FROM ONLY
£5.80*
PER ROLL

SAVE
10%



CAT. NO.	THICKNESS	WIDTH	LENGTH	ROLLS / CASE	1	36
AT0201436	0.5 mm	6.3 mm	11 m	36	£6.35	£5.80
AT0401436	1 mm	6.3 mm	11 m	36	£6.80	£6.25

*Minimum order: 1 roll. Price based on an order quantity of 36 rolls (CAT. NO. AT0201436). Price includes 10% discount. Special discount available from 1st January to 30th April 2017.

CRL ROUND MIRROR CLIP SET

- 19mm diameter clips for use with 6mm mirror
- Supplied with No. 8 X 32mm flat head wood screws and plastic anchors
- 4 clips per set

FROM ONLY
£5.95*
PER SET

SAVE
10%



CAT. NO.	FINISH	1	12	24
MC02CH	Chrome	£7.35	£6.60	£5.95
MC02BN	Brushed Nickel	£7.35	£6.60	£5.95

*Minimum order: 1 set. Price based on an order quantity of 24 sets (CAT. NO. MC02CH). Price includes 10% discount. Special discount available from 1st January to 30th April 2017.

CRL ALUMINIUM TAPE WITH LINER

- Protects the back of the mirror against moisture ingress
- 600mm x 45m

FROM ONLY
£23.90*
PER ROLL

SAVE
10%



CAT. NO.	DESCRIPTION	1	10	25
2108600	Aluminium Tape with Liner	£32.95	£27.00	£23.90
2108600A	Premium Aluminium Tape with Liner	£62.10	£47.75	£38.00

*Minimum order: 1 roll. Price based on an order quantity of 25 rolls (CAT. NO. 2108600). Price includes 10% discount. Special discount available from 1st January to 30th April 2017.

CRL MIRABAC POLYPROPYLENE MIRROR BACKING

- Keeps glass fragments together should mirror accidentally break
- accidentally break thus reducing the chance of personal injury
- Ready to use and easy-to-apply
- Tested to BS EN 12600
- 60 Micron

FROM ONLY
£8.15*
PER ROLL

GREAT VALUE

SAVE
10%



CAT. NO.	WIDTH	LENGTH	1	10	20
21051A	200mm	100m	£15.75	£12.05	£8.15
21051	300mm	100m	£23.55	£17.95	£12.20
21052	450mm	100m	£36.75	£28.00	£19.00
21053	604mm	100m	£49.65	£37.85	£25.65
21056A	770mm	250m	£154.60	£118.15	£79.85
21058B	650mm	250m	£133.10	£101.40	£68.75
21058A	914mm	250m	£184.40	£140.60	£95.25
21060A	1220mm	250m	£249.55	£190.20	£128.90

*Minimum order: 1 roll. Price based on an order quantity of 20 rolls (CAT. NO. 21051A). Price includes 10% discount. Special discount available from 1st January to 30th April 2017.



CRL Chrome Deluxe Shower Squeegee

CAT. NO. 17600

£13.70

SAVE 10%



CRL GLASS AND MIRROR CLEANER

- A long time favourite of the glass industry
- Ammoniated formula with a pleasant aroma
- Twelve big 660ml cans per case

FROM ONLY
£1.85*
PER CANOWN LABEL
VERSION AVAILABLE

SAVE 10%

CAT. NO.	CONTENTS	12	60	144
EB1701	660ml can	£2.30	£1.95	£1.85

*Minimum order: 12 cans. Price based on an order quantity of 144 cans.
Price includes 10% discount. Special discount available from 1st January to 30th April 2017.

CRL MICRO FIBRE WIPES

- Streak free cleaning on windows and mirrors
- Washable up to 500 times
- 406mm x 406mm size
- Packed two per poly bag with a hanger hook so you can also offer them for resale to your customers

FROM ONLY
£3.60*
PER PACK

CAT. NO.	DESCRIPTION	1	5	10
MFW2	Micro Fibre Wipes	£4.10	£3.80	£3.60

*Minimum order: 1 pack. Price based on an order quantity of 10.

CRL TPC SURFACE PROTECTOR

- Transparent polymer coating
- Water, soil, and stain repellent
- Protects glass and many other surfaces
- Clear coating guards against the adhesion and build-up of dirt, grime, mould, mildew, rust and mineral deposits
- Suitable for clear and sandblasted glass surfaces

FROM ONLY
£6.60*

CAT. NO.	CONTENTS	1	12
TPC16	475ml bottle	£7.20	£6.60
TPC5GL	18.93 litre tub	£206.00	-

*Minimum order: 1 bottle. Price based on an order quantity of 12 bottles (CAT. NO. TPC16).
NOTE: Will call trade counter pick-up only for TPC5GL.

CRL INVISIBLE SHIELD GLASS SURFACE SEALER

- Seals, polishes and protects glass
- Keeps surfaces like new
- Prevents build up of soap scum and hard water stains
- Suitable for clear and sandblasted glass surfaces

FROM ONLY
£19.25*

SAVE 10%



To pre-clean the glass before applying the sealer, please order CAT. NO. 17230

CAT. NO.	SIZE	1	10
17200	1 Litre	£22.50	£19.25

*Minimum order: 1 each. Price based on an order quantity of 10.
Price includes 10% discount. Special discount available from 1st January to 30th April 2017.





CRL 6K HYDROPHOBIC SURFACE PROTECTION SYSTEM FOR GLASS AND STAINLESS STEEL

- Stage one - Pre-clean
- Thoroughly cleans glass or stainless steel ready for the protection stage
- Ideal for shower screens and glass railings
- Dries streak-free
- Conforms to EN 45001

CAT. NO.	SIZE	1	6
PC6010	100ml	£5.50	£4.50
PC6025	250ml	£10.05	£9.40
PC6050	500ml	£14.10	£11.75
PC6100	1 Litre	£21.30	£17.90

*Minimum order: 1 bottle. Price based on an order quantity of 6 bottles (CAT. NO. PC6010). Price includes 10% discount. Special discount available from 1st January to 30th April 2017.

FROM ONLY **£4.50***

SAVE 10%

OWN LABEL VERSION AVAILABLE



STAGE ONE PRE-CLEAN

CRL 6K HYDROPHOBIC SURFACE PROTECTION SYSTEM FOR GLASS AND STAINLESS STEEL

- Stage two - Protect
- 3 year protection lifespan
- Protects glass or stainless steel
- Ideal for shower screens and glass railings
- Nano-technology
- Long lasting - wide coverage
- Conforms to EN 45001

SAVE 10%

OWN LABEL VERSION AVAILABLE



STAGE TWO PROTECT

CAT. NO.	SIZE	1	6
6K6010	100ml	£14.85	£13.20
6K6025	250ml	£30.10	£25.15
6K6050	500ml	£52.85	£44.05
6K6100	1 Litre	£98.75	£82.45

*Minimum order: 1 bottle. Price based on an order quantity of 6 bottles (CAT. NO. 6K6010). Price includes 10% discount. Special discount available from 1st January to 30th April 2017.

FROM ONLY **£13.20***

CRL 6K HYDROPHOBIC SURFACE PROTECTION SYSTEM CLOTHS

- To be used with CRL6K Pre-clean and Protect products

CAT. NO.	COLOUR	FOR USE WITH	1	10	50
PCCLOTH	Red	Pre-clean	£1.30	£1.20	£1.10
6KCLOTH	Blue	Protect	£1.30	£1.20	£1.10

*Minimum order: 1 each. Price based on an order quantity of 50 (CAT. NO. PCCLOTH). Price includes 10% discount. Special discount available from 1st January to 30th April 2017.

FROM ONLY **£1.10***

SAVE 10%



CRL AFTERCARE GLASS CLEANER

- Non-silicone based glass cleaner
- Leaves glass clear and smear-free
- Ideal for shower screens

SAVE 10%

RECOMMENDED FOR USE WITH 6K



CAT. NO.	CONTENTS	1	6
AC6050	500ml	£5.20	£4.30

*Minimum order: 1 bottle. Price based on an order quantity of 6 bottles. Price includes 10% discount. Special discount available from 1st January to 30th April 2017.

FROM ONLY **£4.30***



CRL ALUMINIUM U-CHANNEL FOR 6 TO 8MM GLASS

- Available in 2.49m lengths
- Wet glaze with clear silicone
- Extremely versatile extrusion in up to 5 popular finishes - see crlaurence.co.uk

FROM ONLY
£8.15*
PER LENGTH

SAVE
10%

CAT. NO.	FINISH	1	10	40	80	120
SDCD516BA	Brite Anodised	£11.75	£10.65	£9.55	£8.85	£8.15
SDCD516BN	Brushed Nickel	£12.05	£10.90	£9.90	£9.00	£8.40

*Minimum order: 1 each. Price based on an order quantity of 120 (CAT. NO. SDCD516BA).
Price includes 10% discount. Special discount available from 1st January to 30th April 2017.

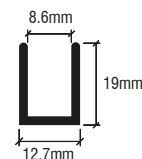

CRL ALUMINIUM U-CHANNEL FOR 10MM GLASS

- Wet glazed with clear silicone to secure glass
- Available in 2.49m and 3.65m stock lengths
- Available in up to 17 finishes - see crlaurence.co.uk

SAVE
10%

FROM ONLY
£9.20*
PER LENGTH

CAT. NO.	FINISH	LENGTH	DEPTH	1	10	40	50	80	100	120	150
SDCD38BA	Brite Anodised	2.49m	19mm	£18.55	£16.50	£14.75		£13.50		£12.35	
SDCD38BN	Brushed Nickel	2.49m	19mm	£21.70	£19.30	£17.30		£15.75		£14.45	
SDCD3812BA	Brite Anodised	3.65m	19mm	£18.10	£16.30	£14.80		£13.60		£12.50	
SDCD3812BN	Brushed Nickel	3.65m	19mm	£18.75	£16.85	£15.30		£14.05		£12.35	
SDCR38BA	Brite Anodised	2.49m	9.5mm	£13.80	£12.25		£11.00		£10.10	£9.20	
SDCR38BN	Brushed Nickel	2.49m	9.5mm	£18.25	£16.25		£14.55		£13.25	£12.15	

*Minimum order: 1 each. Price based on an order quantity of 120 (CAT. NO. SDCD38BA).
Price includes 10% discount. Special discount available from 1st January to 30th April 2017.

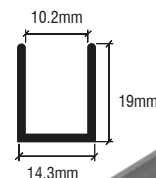
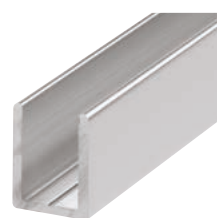

CAT. NO. SDCD38

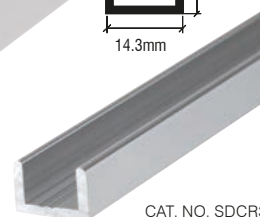

CAT. NO. SDCR38

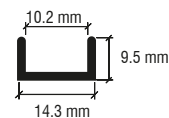

CRL ALUMINIUM U-CHANNEL FOR 10 TO 12MM GLASS

- Wet glaze with clear silicone to secure glass
- Available in three finishes
- 2mm wall thickness
- Sold per 3 metre length

FROM ONLY
£10.00*
PER LENGTH

SAVE
10%

CAT. NO.	FINISH	SIZE	1	10	20
SDCD1515A	Satin Anodised	15mm x 15mm x 15mm	£12.95	£10.90	£10.00
SDCD1515CH	Chrome Plated	15mm x 15mm x 15mm	£41.55	£34.65	£32.00
SDCD1515BN	Brushed Nickel	15mm x 15mm x 15mm	£27.85	£23.25	£21.35
SDCD2020A	Satin Anodised	20mm x 20mm x 20mm	£14.55	£12.85	£11.75
SDCD2020CH	Chrome Plated	20mm x 20mm x 20mm	£52.15	£43.45	£40.10
SDCD2020BN	Brushed Nickel	20mm x 20mm x 20mm	£33.35	£27.75	£25.65
SDCD3020A	Satin Anodised	30mm x 20mm x 30mm	£19.90	£16.65	£15.35
SDCD3020CH	Chrome Plated	30mm x 20mm x 30mm	£86.95	£72.50	£66.95
SDCD3020BN	Brushed Nickel	30mm x 20mm x 30mm	£44.85	£37.40	£34.50
SDCD4020A	Satin Anodised	40mm x 20mm x 40mm	£27.75	£23.10	£21.25
SDCD4020CH	Chrome Plated	40mm x 20mm x 40mm	£84.55	£70.50	£65.05
SDCD4020BN	Brushed Nickel	40mm x 20mm x 40mm	£62.55	£52.15	£48.15

*Minimum order: 1 each. Price based on an order quantity of 20 (CAT. NO. SDCD1515A).
Price includes 10% discount. Special discount available from 1st January to 30th April 2017.

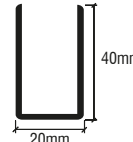
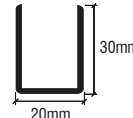
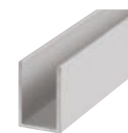
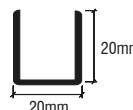
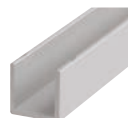
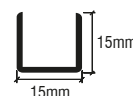
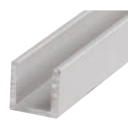

AVAILABLE IN A LARGE RANGE OF STANDARD FINISHES





CRL ALUMINIUM U-CHANNEL FOR 12 MM GLASS

FROM ONLY **£9.50*** PER LENGTH

- Wet glazed with clear silicone to secure fixed panels of glass
- Lower profile allows maximum glass exposure

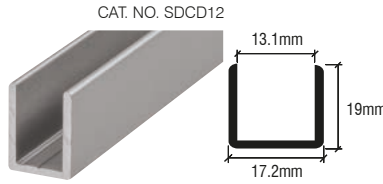

SAVE 10%

CAT. NO.	FINISH	LENGTH	DEPTH	1	10	40	50	80	100	120	150
SDCCD1212BA	Brite Anodised	3.65m	19mm	£19.15	£17.30	£15.70		£14.45		£13.30	
SDCCD1212BN	Brushed Nickel	3.65m	19mm	£19.85	£17.85	£16.25		£14.85		£13.75	
SDCCD12BA	Brite Anodised	2.49m	19mm	£19.00	£16.90	£15.20		£13.80		£12.65	
SDCCD12BN	Brushed Nickel	2.49m	19mm	£22.20	£19.65	£17.75		£16.15		£14.70	
SDCR12BA	Brite Anodised	2.49m	9.5mm	£14.30	£12.70		£11.45		£10.40		£9.50
SDCR12BN	Brushed Nickel	2.49m	9.5mm	£18.75	£16.55		£15.00		£13.65		£12.50

*Minimum order: 1 each. Price based on an order quantity of 120 (CAT. NO. SDCCD12BA). Price includes 10% discount. Special discount available from 1st January to 30th April 2017.

CRL DRY GLAZE U-CHANNEL WITH VINYL FOR 8 AND 10MM GLASS

FROM ONLY **£14.35*** PER LENGTH

- Clear vinyls secure glass in channel and eliminate the need for messy silicone
- Recess in bottom channel hides caulk line
- DUC38 can be used with 8mm glass where RV8DUC rigid vinyl is used (available separately)
- Individually packaged
- 2.49m length

CAT. NO.	FINISH	GLASS THICKNESS	LENGTH	1	10	50
DUC516BA	Brite Anodised	8mm	2.49m	£18.55	£17.35	£15.60
DUC516BN	Brushed Nickel	8mm	2.49m	£21.10	£19.20	£17.65
DUC38BA	Brite Anodised	10mm	2.49m	£17.65	£15.85	£14.35
DUC38BN	Brushed Nickel	10mm	2.49m	£19.75	£17.90	£16.40

*Minimum order: 1 each. Price based on an order quantity of 50 (CAT. NO. DUC38BA). Price includes 10% discount. Special discount available from 1st January to 30th April 2017.

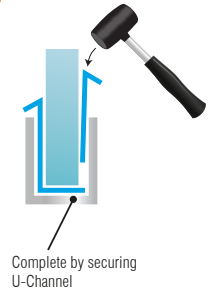
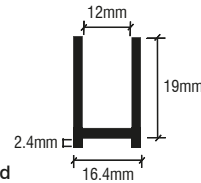
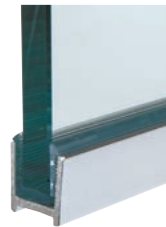

NOTE: glass is not included

SAVE 10%

CRL END CAPS FOR DEEP AND DRY GLAZE U-CHANNEL

- Covers open end of SDCCD12 and SDCCD1212 series u-channel
- Easily applied with a dab of silicone sealant
- Caps are also available for 10mm regular or dry glaze u-channel

CAT. NO.	FINISH	FOR USE WITH	10	60
SDCEC12CH	Chrome	SDCCD12BA/SDCCD1212BA	£1.65	£1.50
SDCEC12BN	Brushed Nickel	SDCCD12BN/SDCCD1212BN	£1.65	£1.50

*Minimum order: 10 each. Price based on an order quantity of 60 (CAT. NO. SDCEC12CH).



FROM ONLY **£1.50***

CRL CLEAR PLASTIC SETTING BLOCKS

- Barely visible blocks are great for use in shower installations
- 80±5 durometer hardness
- Widely used in frameless shower installations

SAVE 10%

FROM ONLY **£3.20*** PER 100 BLOCKS

BEST SELLER

CAT. NO.	THICKNESS	WIDTH	LENGTH	PRICES PER 100 BLOCKS		
				100	500	1000
PSB040	1mm	6mm	50mm	£3.70	£3.35	£3.20
PSB080	2mm	6mm	50mm	£4.10	£3.85	£3.55
PSB125	3mm	6mm	50mm	£4.40	£3.95	£3.80
PSB156	4mm	6mm	50mm	£5.15	£4.70	£4.55
PSB250	6mm	6mm	50mm	£7.75	£7.05	£6.75
PSB375	10mm	6mm	50mm	£12.75	£11.70	£11.00

*Minimum order: 100 blocks. Price based on an order quantity of 1000 blocks (CAT. NO. PSB040). Price includes 10% discount. Special discount available from 1st January to 30th April 2017.



U-CHANNEL AND ACCESSORIES ARE AVAILABLE IN A LARGE RANGE OF STANDARD FINISHES



CRL CHROME GENEVA SERIES SHOWER HINGES

- Our most popular hinge series
- Self-centering with reversible 5 degree pivot pin
- For 8, 10 or 12mm monolithic toughened glass
- Adjustable hinges also available

For more details and finishes, visit crlaurence.co.uk

CAT. NO.	DESCRIPTION	1	16
GEN037CH	Wall Mount Full Back Plate Hinge	£21.95	£20.00
GEN044CH	Wall Mount Offset Back Plate Hinge	£21.95	£20.00
GEN180CH	180 Degree Glass-to-Glass Hinge	£29.65	£26.95
GEN092CH	90 Degree Glass-to-Glass Hinge	£34.85	£31.65

*Minimum order: 1 each. Price based on an order quantity of 16 (CAT. NO. GEN037CH). Price includes 10% discount. Special discount available from 1st January to 30th April 2017.

FROM ONLY
£20.00*

CAT. NO.
GEN044CH



SAVE
10%



CRL CHROME ALTEA SERIES SHOWER HINGES

- Cover plates hide fixing screws for a sleek modern design
- Solid brass hinge constructions ideal for shower environments
- Easy to install, adjust and fix

For more details, visit crlaurence.co.uk

CAT. NO.	DESCRIPTION	1	10	50
ALT037CH	Wall Mount Full Back Plate Hinge	£20.75	£17.30	£16.00
ALT092CH	90 Degree Glass-to-Glass Hinge	£29.50	£24.55	£22.70
ALT180CH	180 Degree Glass-to-Glass Hinge	£26.90	£22.40	£20.70

*Minimum order: 1 each. Price based on an order quantity of 50 each (CAT. NO. ALT037CH).

FROM ONLY
£16.00*

CAT. NO.
ALT037CH



CRL CHROME PINNACLE SERIES SHOWER HINGES

- Radius corners and beveled edges for an attractive, modern appeal
- Self-centering with reversible 5 degree pivot pin
- For 8, 10 or 12mm monolithic toughened glass
- Adjustable hinges also available

For more details, visit crlaurence.co.uk

CAT. NO.	DESCRIPTION	1	16
P1N037CH	Wall Mount Full Back Plate Hinge	£24.15	£21.95
P1N044CH	Wall Mount Offset Back Plate Hinge	£24.15	£21.95
P1N180CH	180 Degree Glass-to-Glass Hinge	£33.80	£30.70
P1N092CH	90 Degree Glass-to-Glass Hinge	£49.60	£45.10

*Minimum order: 1 each. Price based on an order quantity of 16 (CAT. NO. P1N037CH). Price includes 10% discount. Special discount available from 1st January to 30th April 2017.

FROM ONLY
£21.95*

CAT. NO.
P1N044CH



SAVE
10%



CRL CHROME RIVIERA SERIES PREMIUM SHOWER HINGES

- Hinges lift door when opening to avoid bottom sweep dragging
- Mounting screws concealed
- Made of solid brass
- For 8 to 10mm toughened glass

For more details, visit crlaurence.co.uk

CAT. NO.	DESCRIPTION	1	16
R1V180LNCH	180 Degree left hand Glass-to-Glass Mount Hinge	£28.40	£25.85
R1V180RNCH	180 Degree right hand Glass-to-Glass Mount Hinge	£28.40	£25.85

*Minimum order: 1 each. Price based on an order quantity of 16 (R1V180LNCH). Price includes 10% discount. Special discount available from 1st January to 30th April 2017.

FROM ONLY
£25.85*

CAT. NO.
R1V180RNCH



SAVE
10%



AVAILABLE IN A LARGE RANGE OF STANDARD FINISHES





CRL BACK-TO-BACK EURO STYLE KNOBS

- Available in solid brass or plated aluminium
- For EUSKD1 series: 10mm hole required
- For EUSKD2 series: 12mm hole required
- For 6 to 12mm glass

FROM ONLY **£3.55***

SAVE 10%



CAT. NO.	FINISH	SIZE	MATERIAL	1	10	50
EUSDK1CH	Chrome	30 x 30mm	Solid brass	£9.05	£8.10	£6.40
EUSDK1BN	Brushed nickel	30 x 30mm	Solid brass	£9.05	£8.10	£6.40
EUSDK2CH	Chrome	30 x 30mm	Plated aluminium	£4.75	£4.45	£3.55
EUSDK2BN	Brushed nickel	30 x 30mm	Plated aluminium	£4.75	£4.45	£3.55

*Minimum order: 1 each. Price based on an order quantity of 50 (CAT. NO. EUSDK2CH). Price includes 10% discount. Special discount available from 1st January to 30th April 2017.

CRL BACK-TO-BACK SQUARE STYLE KNOBS

- 28 x 28mm square knob
- Solid brass material
- Mirror quality chrome plating for the perfect finish
- For 6 to 10mm toughened glass

FROM ONLY **£5.65***

SAVE 10%



CAT. NO.	FINISH	DESCRIPTION	1	10	50
ALTS DK2CH	Chrome	Back-to-Back Shower Door Knob	£7.35	£6.05	£5.65

*Minimum order: 1 each. Price based on an order quantity of 50. Price includes 10% discount. Special discount available from 1st January to 30th April 2017.

CRL BM SERIES TUBULAR BACK-TO-BACK PULL HANDLES

- Decorative metal washers also serve to cover any hole defects in glass
- Heavy 19mm diameter tubular construction
- Use 6 to 12mm monolithic toughened glass
- 12mm holes required

FROM ONLY **£12.15***

SAVE 10%



CAT. NO.	FINISH	SIZE	MATERIAL	1	10	50
BM6X6CH	Chrome	152mm	Brass tubing	£14.85	£13.40	£12.15
BM6X6BN	Brushed nickel	152mm	Brass tubing	£14.85	£13.40	£12.15
BM8X8CH	Chrome	203mm	Brass tubing	£16.75	£15.00	£13.65
BM8X8BN	Brushed nickel	203mm	Brass tubing	£16.75	£15.00	£13.65

*Minimum order: 1 each. Price based on an order quantity of 50 (CAT. NO. BM6X6CH). Price includes 10% discount. Special discount available from 1st January to 30th April 2017.

CRL SQ SERIES SQUARE TUBE BACK-TO-BACK PULL HANDLES

- Square corners make this handle the ideal choice to match square cornered hinges
- No metal washers allow for continuity of square profile
- Use 6 to 12mm monolithic toughened glass
- 12mm holes required

FROM ONLY **£22.80***

SAVE 10%



CAT. NO.	FINISH	SIZE	MATERIAL	1	10	50
SQ6X6CH	Chrome	152mm	Brass tubing	£27.90	£25.15	£22.80
SQ6X6BN	Brushed nickel	152mm	Brass tubing	£27.90	£25.15	£22.80
SQ8X8CH	Chrome	203mm	Brass tubing	£30.55	£27.50	£25.05
SQ8X8BN	Brushed nickel	203mm	Brass tubing	£30.55	£27.50	£25.05

*Minimum order: 1 each. Price based on an order quantity of 50 (CAT. NO. SQ6X6CH). Price includes 10% discount. Special discount available from 1st January to 30th April 2017.



CRL SLIMLINE SQUARE SERIES SUPPORT BARS AND BRACKETS

- Components for the fabrication of custom support bars to meet your exact needs
- Square tubing matches geometry of many popular CRL hinges
- Provides fixed panel support for enclosures not going to the ceiling
- For 6 to 8mm glass
- 15mm square tubing



CAT. NO. SQJ43CH



CAT. NO. SQJ46CH



CAT. NO. SQJ49CH



CAT. NO. SQJ41CH



CAT. NO. SQJ41DCH



CAT. NO. SQJ50CH

FROM ONLY
£4.10*

SAVE
10%



CAT. NO. SQJ39CH

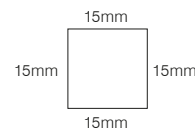

CAT. NO.	DESCRIPTION	FINISH	1	6
SQJ39CH	1m Slimline Square Support Bar	Polished Chrome	£27.25	£24.55
SQJ41CH	Swiveling Glass U-Bracket	Polished Chrome	£7.40	£6.70
SQJ41DCH	Swiveling Flush Mounted U-Bracket	Polished Chrome	£11.85	£10.75
SQJ43CH	Movable U-Bracket	Polished Chrome	£4.55	£4.10
SQJ46CH	Wall Mount Bracket	Polished Chrome	£4.90	£4.45
SQJ49CH	Adjustable Wall Mount Bracket	Polished Chrome	£10.80	£9.75
SQJ50CH	"T" Junction Bracket	Polished Chrome	£9.75	£8.75

*Minimum order: 1 each. Price based on an order quantity of 6 (CAT. NO. SQJ43CH). Price includes 10% discount. Special discount available from 1st January to 30th April 2017.

CRL SQUARE SERIES SUPPORT BARS AND BRACKETS

- Components for the fabrication of custom support bars to meet your exact needs
- Square tubing matches geometry of many popular CRL hinges
- Provides fixed panel support for enclosures not going to the ceiling
- For 6 to 8mm glass
- 19mm square tubing



CAT. NO. SQ45CH



CAT. NO. SQ46CH



CAT. NO. SQ41CH



CAT. NO. SQ43CH



CAT. NO. SQ59CH

SAVE
10%

FROM ONLY
£6.35*

CAT. NO.	DESCRIPTION	FINISH	1	6
SQ59CH	1.5m Support Bar	Chrome	£39.40	£35.70
SQ59BN	1.5m Support Bar	Brushed nickel	£39.40	£35.70
SQ46CH	Wall Mount Bracket	Chrome	£7.00	£6.35
SQ46BN	Wall Mount Bracket	Brushed nickel	£7.00	£6.35
SQ45CH	Adjustable Corner Bracket	Chrome	£19.35	£16.10
SQ45BN	Adjustable Corner Bracket	Brushed nickel	£19.35	£16.10
SQ43CH	Movable Bracket	Chrome	£7.25	£6.55
SQ43BN	Movable Bracket	Brushed nickel	£7.25	£6.55
SQ41CH	Swiveling U-Bracket	Chrome	£11.80	£10.75
SQ41BN	Swiveling U-Bracket	Brushed nickel	£11.80	£10.75

*Minimum order: 1 each. Price based on an order quantity of 6 (CAT. NO. SQ46CH). Price includes 10% discount. Special discount available from 1st January to 30th April 2017.





CRL CHROME ROUND SERIES SUPPORT BARS

- For fabricating glass-to-glass or wall-to-glass support bars
- Provides fixed panel support for enclosures not going to the ceiling
- 19mm diameter straight rod
- No glass fabrication required

FROM ONLY **£12.95***



SAVE 10%

CAT. NO.	LENGTH	FINISH	1	6
S1CH	1m	Chrome	£14.35	£12.95
S2CH	1.3m	Chrome	£18.50	£16.80
S80CH	2.03m	Chrome	£36.80	£33.35

*Minimum order: 1 each. Price based on an order quantity of 6 (CAT. NO. S1CH). Price includes 10% discount. Special discount available from 1st January to 30th April 2017.

CRL CHROME BRACKETS AND FITTINGS FOR ROUND SUPPORT BARS

FROM ONLY **£3.95***

- Components for the fabrication of custom support bars to meet your exact needs
- All will accept S1, S2, and S80 round support bars

CAT. NO.	DESCRIPTION	GLASS THICKNESS	1	6
S3CH	Wall or Ceiling Bracket	-	£7.15	£6.50
S4CH	Adjustable U-Bracket	6mm to 8mm	£14.05	£12.70
S5CH	Adjustable U-Bracket	10mm to 12mm	£14.05	£12.70
S6CH	Movable U-Bracket	6mm to 8mm	£9.05	£8.15
S7CH	Movable U-Bracket	10mm to 12mm	£9.30	£8.45
S8CH	90° Corner Bracket	-	£7.95	£7.25
S9CH	Vertical Support Bracket	6mm to 8mm	£7.95	£7.25
S910CH	Vertical Support Bracket	10mm to 12mm	£7.95	£7.25
S12CH	Wall Mount Fitting	-	£4.35	£3.95
S13CH	Glass Mount Fitting	6mm to 12mm	£8.75	£7.95
S4VCH	Shower Stabilizer	8mm to 12mm	£9.95	£9.30
S6VCH	Shower Stabilizer	8mm to 12mm	£9.95	£9.30

*Minimum order: 1 each. Price based on an order quantity of 6 (CAT. NO. S12CH). Price includes 10% discount. Special discount available from 1st January to 30th April 2017.



SAVE 10%

CRL CHROME SUPPORT BAR COMPLETE SET OFFER

- Slim-line fittings for a streamlined profile
- Wall-to-glass hardware set for 6 to 8mm glass

ONLY **£25.55***

CAT. NO. S1CH
Support bar
Diameter: 19mm
Length: 1m



CAT. NO. S12CH
Slim Line Wall Mount Fitting



CAT. NO. S4CH
Support Bar U-Bracket

SAVE 10%

CAT. NO.	DESCRIPTION	PRICE FOR COMPLETE SET
SUP06CHSET	Support Bar Set	£25.55

*Minimum order: 1 each. Price based on an order quantity of 1 set. Price includes 10% discount. Special discount available from 1st January to 30th April 2017.



CRL CLEAR CO-EXTRUDED BOTTOM WIPE WITH DRIP RAIL

- Snaps on bottom of door
- 45 Degree drip rail assists in deflecting water back into the enclosure
- 2.49m stock length
- Suggested gap: 11mm

CAT. NO.	GLASS THICKNESS	X	1	10	40
P914WS	6mm	16mm	£4.05	£3.55	£3.25
P956WS	8mm	16mm	£4.05	£3.55	£3.25
P990WS	10mm	19mm	£5.35	£4.75	£4.35

*Minimum order: 1 each. Price based on an order quantity of 40 (CAT. NO. P914WS). Price includes 10% discount. Special discount available from 1st January to 30th April 2017.

FROM ONLY
£3.25*

BEST SELLER



SAVE 10%

CRL CLEAR CO-EXTRUDED BOTTOM WIPE

- 45 degree drip rail assists in deflecting water back into enclosure
- Snaps on bottom of door
- For 6 to 8mm glass
- 2.49m stock lengths

CAT. NO.	DESCRIPTION	X	1	10	40
P102WS	With Drip Rail	10mm	£4.40	£4.05	£3.80
P103WS	With Drip Rail and Bulb	10mm	£4.40	£4.05	£3.80

*Minimum order: 1 each. Price based on an order quantity of 40 (CAT. NO. P102WS). Price includes 10% discount. Special discount available from 1st January to 30th April 2017.

FROM ONLY
£3.80*

SAVE 10%

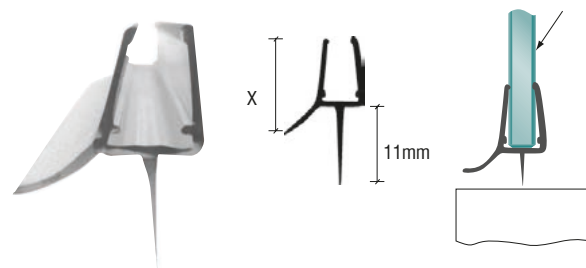

CRL CLEAR POLYCARBONATE BOTTOM RAIL WITH WIPE

- Vinyl insert included
- Snaps onto door bottom to achieve a seal
- Includes insert slot with our SDTW 'T' Wipe
- 2.49m stock length
- Suggested gap: 11mm

CAT. NO.	GLASS THICKNESS	1	10	40
P450BR	8mm	£6.80	£6.05	£5.50

*Minimum order: 1 each. Price based on an order quantity of 40. Price includes 10% discount. Special discount available from 1st January to 30th April 2017.

FROM ONLY
£5.50*

SAVE 10%

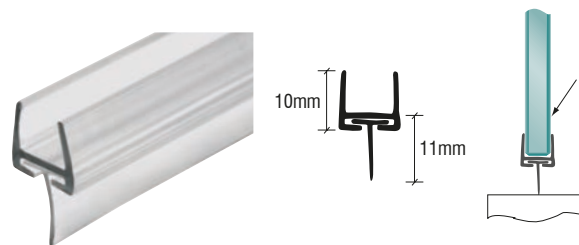

CRL CLEAR BUBBLE WIPE WITH DRIP RAIL

- Can be used on inswing and outswing doors
- Adhere flat base to glass edge or wall with CRL Very High Bond Tape, such as CAT. NO. AT0401436

CAT. NO.	GLASS THICKNESS	1	10	40
P141WS	6mm to 8mm	£6.60	£5.85	£5.45

*Minimum order: 1 each. Price based on an order quantity of 40. Price includes 10% discount. Special discount available from 1st January to 30th April 2017.

FROM ONLY
£5.45*

SAVE 10%

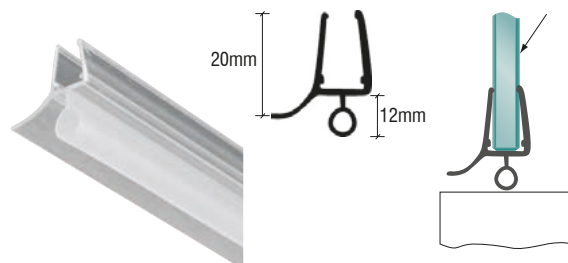



CRL CLEAR 90 DEGREE MAGNETIC PROFILE FOR GLASS-TO-GLASS

FROM ONLY
£4.55*

- Provides positive door closure
- Mix and match configurations to achieve desired result
- Made of co-extruded plastic with soft magnetic receiver
- Recommended gap between each door is 22.2mm

SAVE
10%



CAT. NO.	GLASS THICKNESS	1	10	40
PMC8	6mm to 8mm	£5.30	£4.90	£4.55
PMC10	10mm to 12mm	£8.10	£7.50	£6.95

*Minimum order: 1 each. Price based on an order quantity of 40 (CAT. NO. PMC8). Price includes 10% discount. Special discount available from 1st January to 30th April 2017.

CRL CLEAR 45 DEGREE LH MAGNETIC PROFILE FOR GLASS-TO-GLASS

FROM ONLY
£4.55*

- Provides positive door closure
- Mix and match configurations to achieve desired result
- Made of co-extruded plastic with soft magnetic receiver
- Recommended gap between each door is 22.2mm

SAVE
10%



CAT. NO.	GLASS THICKNESS	1	10	40
PMA8	6mm to 8mm	£5.30	£4.90	£4.55
PMA10	10mm to 12mm	£8.10	£7.50	£6.95

*Minimum order: 1 each. Price based on an order quantity of 40 (CAT. NO. PMA8). Price includes 10% discount. Special discount available from 1st January to 30th April 2017.

CRL CLEAR 45 DEGREE RH MAGNETIC PROFILE FOR GLASS-TO-GLASS

FROM ONLY
£4.55*

- Provides positive door closure
- Mix and match configurations to achieve desired result
- Made of co-extruded plastic with soft magnetic receiver
- Recommended gap between each door is 22.2mm

SAVE
10%

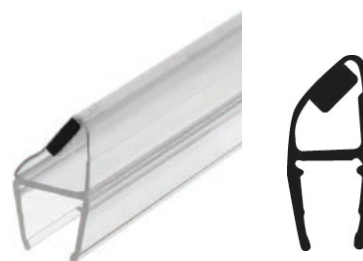

CAT. NO.	GLASS THICKNESS	1	10	40
PMB8	6mm to 8mm	£5.30	£4.90	£4.55
PMB10	10mm to 12mm	£8.10	£7.50	£6.95

*Minimum order: 1 each. Price based on an order quantity of 40 (CAT. NO. PMB8). Price includes 10% discount. Special discount available from 1st January to 30th April 2017.

CRL CLEAR 'Y' JAMB SEAL WITH SOFT LEG

FROM ONLY
£4.40*

- Soft vinyl single leg for quieter door closure
- Snaps onto fixed panel
- For glass-to-glass applications
- Suggested gap: 4.7mm

SAVE
10%



CAT. NO.	GLASS THICKNESS	X	Y	1	10	40
PCC8	8mm	19mm	11mm	£5.25	£4.85	£4.40
PCC10	10mm	21mm	12mm	£8.05	£7.35	£6.85

*Minimum order: 1 each. Price based on an order quantity of 40 (CAT. NO. PCC8). Price includes 10% discount. Special discount available from 1st January to 30th April 2017.



CRL ADJUSTABLE SHELF BRACKET

- For glass or wood shelves 3mm to 24mm thick
- For shelves up to 254mm deep (protrusion from wall)
- Maximum recommended weight by pair is 20kg
- Includes: adjusting screw, mounting screw and foam gasket
- Material: zinc plated
- Sold in pairs

CAT. NO.	FINISH	1	12	60
DL631CH	Chrome	£5.70	£5.05	£4.65
DL631BN	Brushed Nickel	£6.50	£5.85	£5.25
DL631W	White	£6.15	£5.60	£5.00

*Minimum order: 1 pair. Price based on an order quantity of 60 pairs (CAT. NO. DL631CH). Price includes 10% discount. Special discount available from 1st January to 30th April 2017.



FROM ONLY
£4.65*
PER PAIR

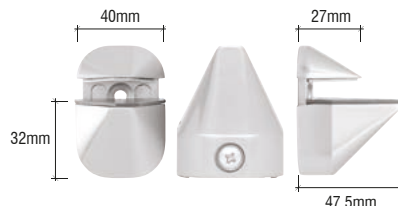

BEST SELLER



CRL INTERIOR SHOWER SHELF CLAMP

- For shelves up to 127mm deep (protrusion from wall)
- For 6mm to 10mm glass
- No glass fabrication required
- Available in three styles and up to eight finishes online at crlaurence.co.uk
- Material: solid brass

CAT. NO.	FINISH	WIDTH	DEPTH	1	10	50
FA10CH	Chrome	28.6mm	25.4mm	£5.00	£4.35	£3.85
FA10BN	Brushed Nickel	28.6mm	25.4mm	£5.00	£4.35	£3.85

*Minimum order: 1 each. Price based on an order quantity of 50 (CAT. NO. FA10CH). Price includes 10% discount. Special discount available from 1st January to 30th April 2017.

FROM ONLY
£3.85*



NOTE: Wall anchor screws not included

CRL INTERIOR SHOWER SHELF CLAMP

- For shelves up to 127mm deep (protrusion from wall)
- For 6mm to 10mm glass
- No glass fabrication required
- Available in three styles and up to eight finishes online at crlaurence.co.uk
- Material: solid brass

CAT. NO.	FINISH	WIDTH	DEPTH	1	10	50
FA11CH	Chrome	100mm	25.4mm	£10.55	£9.25	£8.20
FA11BN	Brushed Nickel	100mm	25.4mm	£10.55	£9.25	£8.20

*Minimum order: 1 each. Price based on an order quantity of 50 (CAT. NO. FA11CH). Price includes 10% discount. Special discount available from 1st January to 30th April 2017.

FROM ONLY
£8.20*

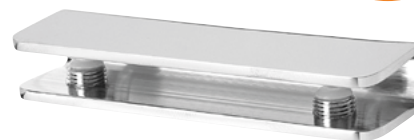

NOTE: Wall anchor screws not included

CRL ROUNDED INTERIOR SHOWER SHELF CLAMP

- For shelves up to 127mm deep (protrusion from wall)
- For 6mm to 10mm glass
- No glass fabrication required
- Available in three styles and up to eight finishes online at crlaurence.co.uk
- Material: solid brass

CAT. NO.	FINISH	WIDTH	DEPTH	1	10	50
FA12CH	Chrome	49.2mm	25.4mm	£7.05	£6.40	£5.70
FA12BN	Brushed Nickel	49.2mm	25.4mm	£7.05	£6.40	£5.70

*Minimum order: 1 each. Price based on an order quantity of 50 (CAT. NO. FA12CH). Price includes 10% discount. Special discount available from 1st January to 30th April 2017.

FROM ONLY
£5.70*



NOTE: Wall anchor screws not included





CRL ALUMINIUM SHELVING EXTRUSION

- Designed to support glass shelves without a lot of visible metal
- Easy to install
- 2.4m stock length that you cut to size

CAT. NO.	FINISH	GLASS THICKNESS	1	10
SE1496BA	Brite Anodised	6mm	£33.90	£31.40
SE1496BN	Brushed Nickel	6mm	£37.00	£34.10
SE3896BA	Brite Anodised	10mm	£44.50	£41.10
SE3896BN	Brushed Nickel	10mm	£49.55	£45.70

*Minimum order: 1 each. Price based on an order quantity of 10 (CAT. NO. SE1496BA).

FROM ONLY
£31.40*

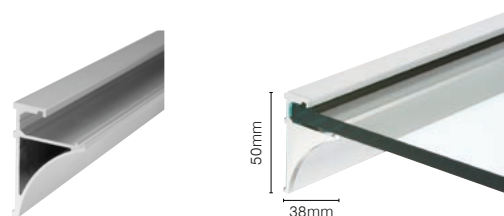

NOTE: End caps are sold separately, see below.

CRL END CAPS FOR ALUMINIUM SHELVING EXTRUSION

- Made of injection molded plastic and easily installed with EURTV408C clear silicone
- Cover exposed edges of our aluminium shelving extrusions
- Formed and shaped to fit, ready to install
- Sold in pairs

CAT. NO.	FINISH	USE WITH	1	10
END14BA	Brite Anodised	SE1496BA	£1.50	£1.35
END14BN	Brushed Nickel	SE1496BN	£1.50	£1.35
END38BA	Brite Anodised	SE3896BA	£1.60	£1.50
END38BN	Brushed Nickel	SE3896BN	£1.60	£1.50

*Minimum order: 1 pair. Price based on an order quantity of 10 pairs (CAT. NO. END14BA).

FROM ONLY
£1.35*
PER PAIR

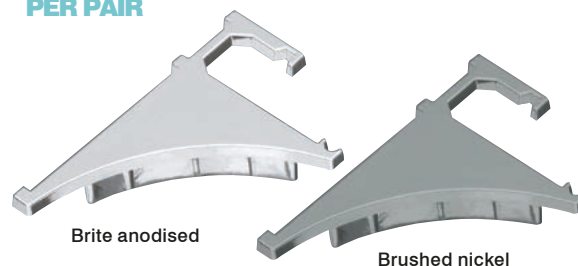

CRL STICK-ON FINGER PULLS

- Perfect for sliding showcase and cabinet glass doors
- Easy-to-install, just peel and stick
- Available in five popular colours online at crlaurence.co.uk
- 19mm wide x 70mm long x 3.2mm deep

CAT. NO.	COLOUR	QTY/PACK	1	5	50	100	300
FP88	Clear	1	£0.53	-	£0.47	£0.43	£0.38
FP86	Silver	1	£0.53	-	£0.47	£0.43	£0.38
FP88BX	Clear	100	£32.05	£29.65	-	-	-
FP86BX	Silver	100	£32.05	£29.65	-	-	-

*Minimum order: 1 each. Price based on an order quantity of 300 (CAT. NO. FP88).

FROM ONLY
£0.38*

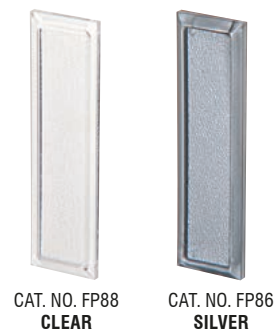

CRL THREADED FINGER PULL FOR GLASS DOORS

- Designed for 'all glass' showcase and cabinet doors
- Requires drilling a 22mm hole in glass
- Easy to install in glass from 6mm to 8mm thick

CAT. NO.	FINISH	1	50
KV836	Anochrome	£1.45	£1.35

*Minimum order: 1 each. Price based on an order quantity of 50.

FROM ONLY
£1.35*





CRL CABO SLIDING SHOWER DOOR

- For use with 8, 10 or 12mm toughened glass
- Featuring the double soft-brake system
- Concealed overhead roller design
- Available in five architectural finishes



Square clamp shown on sliding panel



Bottom floor guide included



Cabo 180 Degree Kit includes:

- 1 - 2.13m length header support bar
- 2 - Top clamps with covers
- 2 - Wall mount brackets
- 2 - Top fixed glass fasteners with covers
- 1 - Bottom guide



NOTE: Bottom fixed glass attachments, handles or knobs must be ordered separately.



Square Clamp Style



Rounded Clamp Style



THE NEXT GENERATION IN SURFACE PROTECTION
SEE PAGE 29



FROM ONLY
£323.00*

CAT. NO.	DESCRIPTION	FINISH	1	6	12
CABR84CH	Rounded Style 180 Degree kit	Chrome	£389.85	£359.50	£331.75
CABS84CH	Square Style 180 Degree kit	Chrome	£381.00	£350.00	£323.00
CAB90CH	90 Degree wall-to-glass accessory kit	Chrome	£175.00	£160.00	£147.00

*Minimum order: 1 each. Price based on an order quantity of 12 (CAT. NO. CABS84CH). Price includes 10% discount. Special discount available from 1st January to 30th April 2017.





CRL DELUXE SERENITY SERIES SLIDING SHOWER DOOR SYSTEM

• For use with 8 to 10mm monolithic toughened glass

CAT. NO. SER78BS BRUSHED STAINLESS DELUXE 180 DEGREE KIT
CAT. NO. SER78PS POLISHED STAINLESS DELUXE 180 DEGREE KIT

Deluxe 180 Degree Kit Includes:

- 1 - 2m length header support bar
- 4 - Rollers
- 1 - Stopper
- 2 - Track holder fittings for wall
- 2 - Track holder fittings for fixed panel
- 1 - Thru-glass pull
- 1 - Door guide
- 1 - 2.16m length clear L-jamb

FROM ONLY
£226.00*

IDEAL FOR SHOWROOMS

VISIT crlaurence.co.uk
and view CAT. NO. EUSLUK14



Image shown here:
CAT. NO. SER90BS



CAT. NO.	DESCRIPTION	FINISH	1	6
SER78BS	Deluxe 180 Degree Serenity Kit	Brushed Stainless	£247.00	£226.00
SER78PS	Deluxe 180 Degree Serenity Kit	Polished Stainless	£264.00	£243.00
SER90BS	90 Degree Accessory Kit	Brushed Stainless	£7.30	£6.60
SER90PS	90 Degree Accessory Kit	Polished Stainless	£7.65	£7.00
SERAHW2BS	Track Holder Fittings for Wall	Brushed Stainless	£20.35	£18.40
SERAHW2PS	Track Holder Fittings for Wall	Polished Stainless	£23.60	£21.30

*Price based on order quantity of 6 (CAT. NO. SER78BS).
Minimum order: 1 each. Finishes can be combined for quantity pricing.
90 degree accessory kit sold separately. Glass not included.

SEE THE COMPLETE RANGE

VISIT crlaurence.co.uk
and view CAT. NO. SDH17UK



MIRROR AND SHOWER ESSENTIALS





CRL HYDROSLIDE SLIDING SHOWER DOOR SYSTEM

- For use with 8mm to 10mm monolithic toughened glass
- Excellent design for compact areas
- Quick and easy installation
- Clean, sleek lines
- Available in four stock finishes, custom finishes available
- Custom units available by special order

CAT. NO. HYDK60CH Brite Anodised/Chrome
180 Degree Standard Kit 1524mm

CAT. NO. HYDK84CH Brite Anodised/Chrome
180 Degree Standard Kit 2134mm

180 DEGREE STANDARD KIT CONSISTS OF:

- 1 - Sliding glass door upper track
- 2 - Hangers for sliding glass door
- 2 - Sliding glass door rollers
- 2 - Sliding glass door roller stops
- 1 - Sliding glass door floor guide
- 2 - 90 degree wall-to-upper track connectors
- 2 - 180 degree glass-to-sliding track connectors
- 1 - 914mm half-round SDT980 threshold
- 1 - 2489mm DK98L L-seal for wall

NOTE: Bottom fixed glass attachments, handles or knobs must be ordered separately.

90 DEGREE** WALL-TO-GLASS ACCESSORY KIT CONSISTS OF:

- 1 - 90 degree glass-to-sliding track connector
- 1 - 90 degree wall-to-glass bracket

**90 degree units require that you order one 180 degree Standard Kit plus one 90 degree Accessory Kit



CAT. NO. HYDA9
90 Degree Kit



FROM ONLY
£180.45*

CAT. NO.	DESCRIPTION	FINISH	1	6
HYDK60CH	Standard 180 degree kit 1524mm	Brite Anodised / Chrome	£191.55	£180.45
HYDK84CH	Standard 180 degree kit 2134mm	Brite Anodised / Chrome	£206.55	£187.75
HYDA9CH	90 degree wall-to-glass accessory kit	Brite Anodised / Chrome	£52.80	£48.05
HYDK60BN	Standard 180 degree kit 1524mm	Brushed Nickel	£215.10	£195.40
HYDK84BN	Standard 180 degree kit 2134mm	Brushed Nickel	£230.10	£211.30
HYDA9BN	90 degree wall-to-glass accessory kit	Brushed Nickel	£61.70	£56.10

*Minimum order: 1 kit. Price based on an order quantity of 6 (CAT. NO. HYDK60CH).





GLASS RAILING HARDWARE

Get your copy now!

**Architectural
Glass Fixings**

CAT. NO EUAGF15



contact us

Contact our technical advisers for more details on our architectural glass fixings

CRL@crlaurence.co.uk or **00 800 0421 6144**



TAPER-LOC[®] X

DRY GLAZE RAILING SYSTEM

LIGHTER, MORE AFFORDABLE AND EVEN STRONGER!

Install Glass Railings with ease...

- 50% faster to install than alternatives
- Save Time and Money - The horizontal TAPER-LOC[®] design allows the system to be adjusted, dismantled and re-set
- Meets BS 6180: 2011 requirements
- For use with monolithic and laminated toughened glass
- Easy installation with one compact installation/removal tool

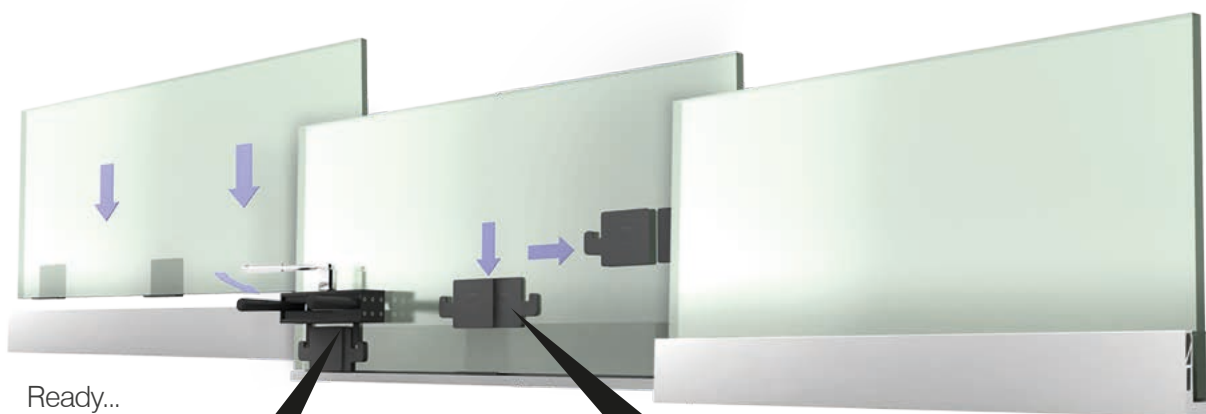

Ready...

Set...

Done.

The TAPER-LOC[®] Installation/Removal Tool compresses the Tapers together to lock the glass in place

TAPER-LOC[®] Tapers insert into the Aluminium Base Shoe

U.S. Patent Numbers 8.122.654 & 8.201.366
and Commonwealth of Australia Patent Numbers
2008207524 and 2012202256



Order your free copy
from taper-loc.co.uk
CAT. NO. EUTL14



To see a demonstration, visit taper-loc.co.uk

NEW

CRL 9BL AND 8B SERIES ALUMINIUM BASE SHOES

NOW 30% LIGHTER

- For use with CRL TAPER-LOC® System
- Can be clad in 6 standard architectural finishes
- Also available in satin anodised and brushed nickel finishes - no need for cladding!
- Only laminated system pursuing ICC-ES approval
- Bottom and side drilled base shoe available

FROM ONLY
£126.20*

SAVE 10%

INNOVATIVE EXTRUDED STRUCTURE



CAT. NO.	GLASS TYPE	GLASS THICKNESS	DRILLED PATTERN	FINISH	USE WITH TAPERS	1	6
9BL68D	Laminated toughened	17.52mm	Bottom drilled	Mill	LTL96X	£163.60	£147.25
9BL68DBN	Laminated toughened	17.52mm	Bottom drilled	Brushed Nickel	LTL96X	£165.75	£149.30
9BL68DSA	Laminated toughened	17.52mm	Bottom drilled	Satin Anodised	LTL96X	£176.35	£158.80
9BL68F	Laminated toughened	17.52mm	Side drilled	Mill	LTL96X	£163.60	£147.30
9BL21D	Laminated toughened	21.52mm	Bottom drilled	Mill	LTL10X	£159.95	£145.50
9BL21DBN	Laminated toughened	21.52mm	Bottom drilled	Brushed Nickel	LTL10X	£172.05	£156.50
9BL21DSA	Laminated toughened	21.52mm	Bottom drilled	Satin Anodised	LTL10X	£176.45	£162.45
9BL21F	Laminated toughened	21.52mm	Side drilled	Mill	LTL10X	£157.05	£144.55
8B10D	Monolithic toughened	12mm	Bottom drilled	Mill	TL5X10	£138.80	£126.20
8B10DBN	Monolithic toughened	12mm	Bottom drilled	Brushed Nickel	TL5X10	£154.50	£139.00
8B10DSA	Monolithic toughened	12mm	Bottom drilled	Satin Anodised	TL5X10	£154.50	£139.00
8B10F	Monolithic toughened	12mm	Side drilled	Mill	TL5X10	£143.27	£129.00
8B58D	Monolithic toughened	15mm	Bottom drilled	Mill	TL5X10	£143.05	£128.75
8B58DBN	Monolithic toughened	15mm	Bottom drilled	Brushed Nickel	TL5X10	£154.25	£138.80
8B58DSA	Monolithic toughened	15mm	Bottom drilled	Satin Anodised	TL5X10	£154.25	£138.80
8B58F	Monolithic toughened	15mm	Side drilled	Mill	TL5X10	£143.05	£128.75
8B34D	Monolithic toughened	19mm	Bottom drilled	Mill	TL5X10	£143.50	£126.90
8B34DBN	Monolithic toughened	19mm	Bottom drilled	Brushed Nickel	TL5X10	£159.85	£143.90
8B34DSA	Monolithic toughened	19mm	Bottom drilled	Satin Anodised	TL5X10	£159.85	£143.90
8B34F	Monolithic toughened	19mm	Side drilled	Mill	TL5X10	£148.30	£133.50

*Minimum order: 1 each. Price based on an order quantity of 6 (CAT. NO. 8B10D). Price includes 10% discount. Special discount available from 1st January to 30th April 2017.



Gasket Retention Groove Secures the Top Rubber in the Base Shoe



CONFORMS TO
BS 6180:2011

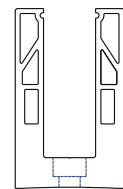

Bottom Drilled Hole Pattern "D"

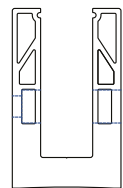

Side Drilled Hole Pattern "F"



CRL LARGE D SHAPE FLAT BACK GLASS CLAMPS

- For use on mezzanines, partitions, railings and windbreaks
- Steel pin included for additional glass support
- For 8 to 12.76mm toughened or laminated glass • Sold individually

SAVE
10%

FROM ONLY
£1.70*

Rubber gaskets are sold separately. CAT. NO.'s EUZ8G to EUZ1276G

CAT. NO.	FINISH	SIZE	1	50	100	500
EUZFBBS	Brushed Stainless	63 x 45 x 30mm	£6.50	£5.85	£5.35	£4.95
EUZFBPS	Polished Stainless	63 x 45 x 30mm	£7.70	£6.90	£6.15	£5.75
EUZFBZ	Raw Zinc	63 x 45 x 30mm	£2.20	£2.00	£1.85	£1.70
EUZFBBN	Brushed Nickel	63 x 45 x 30mm	£2.80	£2.55	£2.35	£2.05

*Minimum order: 1 each. Price based on an order quantity of 500 (CAT. NO. EUZFBZ). Price includes 10% discount. Special discount available from 1st January to 30th April 2017.

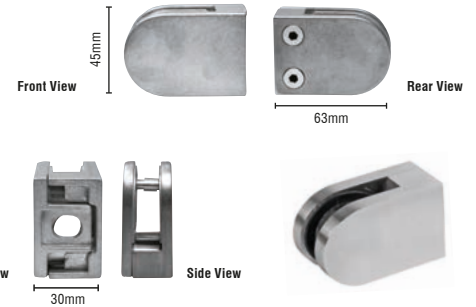

CRL LARGE D SHAPE 42.4MM RADIUS BACK GLASS CLAMPS

- Radius back for use with 42.4mm diameter posts
- For use on mezzanines, partitions, railings and windbreaks
- Steel pin included for additional glass support
- For 8 to 12.76mm toughened or laminated glass
- Sold individually

FROM ONLY
£2.25*

SAVE
10%

Rubber gaskets are sold separately. CAT. NO.'s EUZ8G to EUZ1276G

CAT. NO.	FINISH	SIZE	1	50	100	500
EUZ42RBS	Brushed Stainless	63 x 45 x 30mm	£6.95	£6.20	£5.65	£5.15
EUZ42RPS	Polished Stainless	63 x 45 x 30mm	£8.05	£7.25	£6.55	£6.05
EUZ42RBN	Brushed Nickel	63 x 45 x 30mm	£3.00	£2.70	£2.45	£2.25

*Minimum order: 1 each. Price based on an order quantity of 500 (CAT. NO. EUZ42RBN). Price includes 10% discount. Special discount available from 1st January to 30th April 2017.

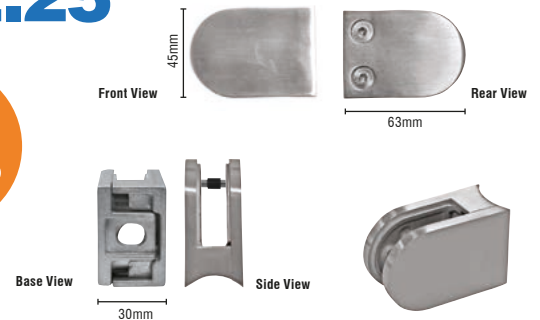

CRL LARGE D SHAPE 48.3MM RADIUS BACK GLASS CLAMPS

- Radius back for use with 48.3mm diameter posts
- For use on mezzanines, partitions, railings and windbreaks
- Steel pin included for additional glass support
- For 8 to 12.76mm toughened or laminated glass
- Sold individually

FROM ONLY
£2.25*

SAVE
10%

Rubber gaskets are sold separately. CAT. NO.'s EUZ8G to EUZ1276G

CAT. NO.	FINISH	SIZE	1	50	100	500
EUZ48RBS	Brushed Stainless	63 x 45 x 30mm	£6.95	£6.20	£5.65	£5.15
EUZ48RPS	Polished Stainless	63 x 45 x 30mm	£8.05	£7.25	£6.55	£6.05
EUZ48RBN	Brushed Nickel	63 x 45 x 30mm	£3.00	£2.70	£2.45	£2.25

*Minimum order: 1 each. Price based on an order quantity of 500 (CAT. NO. EUZ48RBN). Price includes 10% discount. Special discount available from 1st January to 30th April 2017.

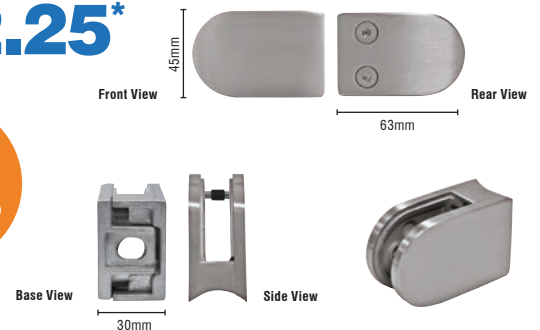

CRL RUBBER GASKETS FOR EUZFB/EUZ42/EUZ48 SERIES CLAMPS

- For use with toughened or laminated glass
- Sold by the pair • Black colour

FROM ONLY
£0.26*
PER PAIR

For use with EUZFB, EUZ42 and EUZ48 Series Clamps

CAT. NO.	THICKNESS	GLASS TYPE	1	50	100	500
EUZ8G	8mm	Toughened	£0.36	£0.30	£0.28	£0.26
EUZ876G	8.76mm	Laminated	£0.36	£0.30	£0.28	£0.26
EUZ10G	10mm	Toughened	£0.36	£0.30	£0.28	£0.26
EUZ1076G	10.76mm	Laminated	£0.36	£0.30	£0.28	£0.26
EUZ12G	12mm	Toughened	£0.36	£0.30	£0.28	£0.26
EUZ1276G	12.76mm	Laminated	£0.36	£0.30	£0.28	£0.26

*Minimum order: 1 pair. Price based on an order quantity of 500 pairs (CAT. NO. EUZ8G).





CRL FLAT BACK GLASS CLAMPS

- For use on mezzanines, partitions, railings and windbreaks
- Available in 316 grade brushed or polished stainless steel
- For 10 and 12mm glass
- Comes complete with gaskets for monolithic toughened glass
- Sold Individually

For laminated glass, use gasket CAT. NO. EUZ5GASK107
For support plate, order CAT. NO. EUZ5SUPP0RT

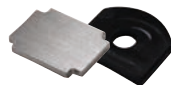

CAT. NO.	FINISH	SIZE	1	6
EUZ51012BS	Brushed Stainless	63 x 45 x 27mm	£12.95	£11.80
EUZ51012PS	Polished Stainless	63 x 45 x 27mm	£14.25	£12.95

*Minimum order: 1 each. Price based on an order quantity of 6 (CAT. NO. EUZ51012BS).
Price includes 10% discount. Special discount available from 1st January to 30th April 2017.

FROM ONLY
£11.80*

SAVE
10%

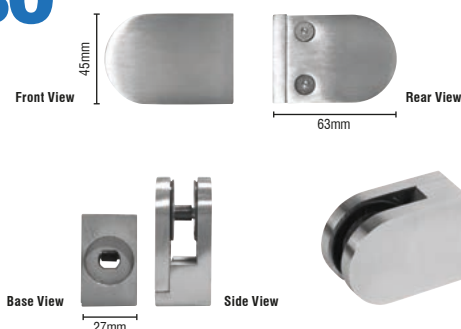

CRL RADIUS BACK GLASS CLAMPS

- For use on mezzanines, partitions, railings and windbreaks
- Available in 316 grade brushed or polished stainless steel
- For 10 and 12mm glass
- Comes complete with gaskets for monolithic toughened glass • Sold Individually

For laminated glass, use gasket CAT. NO. EUZ5GASK107
For support plate, order CAT. NO. EUZ5SUPP0RT



CAT. NO.	FINISH	SIZE	1	6
EUZ51012RBS	Brushed Stainless	63 x 45 x 27mm	£12.95	£11.80
EUZ51012RPS	Polished Stainless	63 x 45 x 27mm	£14.25	£12.95

*Minimum order: 1 each. Price based on an order quantity of 6 (CAT. NO. EUZ51012RBS).
Price includes 10% discount. Special discount available from 1st January to 30th April 2017.

FROM ONLY
£11.80*

SAVE
10%

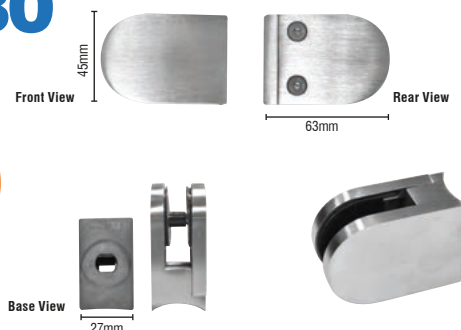

CRL SQUARE TYPE FLAT BACK GLASS CLAMPS

- For use on mezzanines, partitions, railings and windbreaks
- For 8 to 10.76mm toughened or laminated glass • Sold individually

Rubber gaskets are sold separately, CAT. NO.'s EUZS8G to EUZS1076G

CAT. NO.	FINISH	SIZE	1	50	100	500
EUZSFBBBS	Brushed Stainless	45 x 45 X 27mm	£4.95	£4.50	£4.10	£3.75
EUZSFBPS	Polished Stainless	45 x 45 X 27mm	£6.35	£5.75	£5.15	£4.75
EUZSFBBZ	Raw Zinc	45 x 45 X 27mm	£1.72	£1.55	£1.40	£1.30
EUZSFBBN	Brushed Nickel	45 x 45 x 27mm	£2.65	£2.35	£2.15	£1.95

*Minimum order: 1 each. Price based on an order quantity of 500 (CAT. NO. EUZSFBBZ).
Price includes 10% discount. Special discount available from 1st January to 30th April 2017.

FROM ONLY
£1.30*

SAVE
10%

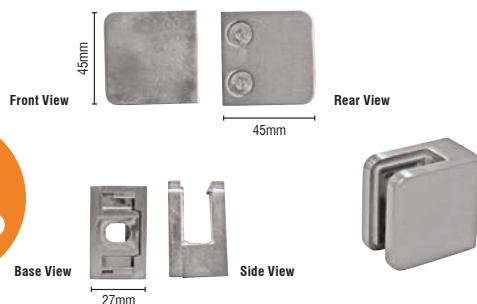

CRL RUBBER GASKETS FOR EUZSF SERIES CLAMPS

- For use with toughened or laminated glass
- Sold by the pair
- Black color

For use with EUZSF Series Clamps

CAT. NO.	THICKNESS	GLASS TYPE	1	50	100	500
EUZS8G	8mm	Toughened	£0.31	£0.25	£0.22	£0.19
EUZS876G	8.76mm	Laminated	£0.31	£0.25	£0.22	£0.19
EUZS10G	10mm	Toughened	£0.31	£0.25	£0.22	£0.19
EUZS1076G	10.76mm	Laminated	£0.31	£0.25	£0.22	£0.19

*Minimum order: 1 pair. Price based on an order quantity of 500 pairs (CAT. NO. EUZS8G).

FROM ONLY
£0.19*
PER PAIR





CRL SQUARE TYPE FLAT BACK GLASS CLAMPS

- For use on mezzanines, partitions, railings and windbreaks
- Side plates for use with laminated glass
- For 6 to 12.76mm toughened or laminated glass
- Safety pin included • Sold individually

Rubber gaskets are sold separately, see chart below for options, from CAT. NO.'s EUZLS6GL to EUZLS1276GL

CAT. NO.	FINISH	SIZE	1	50	100	500
EUZLSFBBSL	Brushed Stainless	55 x 55 x 35mm	£10.85	£9.80	£8.85	£8.15
EUZLSFBZL	Raw Zinc	55 x 55 x 35mm	£3.00	£2.80	£2.25	£2.10

*Minimum order: 1 each. Price based on an order quantity of 500 (CAT. NO. EUZLSFBZL). Price includes 10% discount. Special discount available from 1st January to 30th April 2017.

FROM ONLY
£2.10*

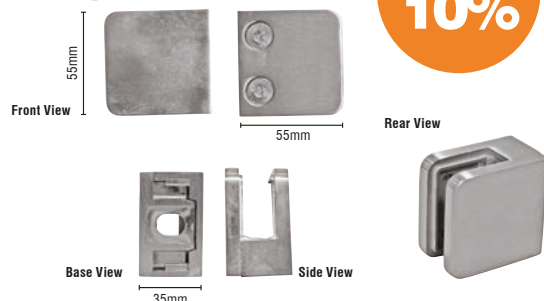

CRL SQUARE TYPE 42.4MM RADIUS BACK GLASS CLAMPS

- Radius back for use with 42.4mm diameter posts
- For use on mezzanines, partitions, railings and windbreaks
- Side plates for use with laminated glass included
- For 6 to 12.76mm toughened or laminated glass
- Safety pin included • Sold individually

Rubber gaskets are sold separately, see chart below for options, from CAT. NO.'s EUZLS6GL to EUZLS1276GL

CAT. NO.	FINISH	SIZE	1	50	100	500
EUZLS42RBSL	Brushed Stainless	55 x 55 x 35mm	£10.85	£9.80	£8.85	£8.15
EUZLS42RZL	Raw Zinc	55 x 55 x 35mm	£3.00	£2.80	£2.25	£2.10

*Minimum order: 1 each. Price based on an order quantity of 500 (CAT. NO. EUZLS42RZL). Price includes 10% discount. Special discount available from 1st January to 30th April 2017.

FROM ONLY
£2.10*



CRL SQUARE TYPE 48.3MM RADIUS BACK GLASS CLAMPS

- Radius back for use with 48.3mm diameter posts
- For use on mezzanines, partitions, railings and windbreaks
- Side plates for use with laminated glass included
- For 6 to 12.76mm toughened or laminated glass
- Safety pin included • Sold individually

Rubber gaskets are sold separately, see chart below for options, from CAT. NO.'s EUZLS6GL to EUZLS1276GL

CAT. NO.	FINISH	SIZE	1	50	100	500
EUZLS48RBSL	Brushed Stainless	55 x 55 x 35mm	£10.85	£9.80	£8.85	£8.15
EUZLS48RZL	Raw Zinc	55 x 55 x 35mm	£3.00	£2.80	£2.25	£2.10

*Minimum order: 1 each. Price based on an order quantity of 500 (CAT. NO. EUZLS48RZL). Price includes 10% discount. Special discount available from 1st January to 30th April 2017.

FROM ONLY
£2.10*



CRL RUBBER GASKETS FOR EUZLSF/ EUZLS42/EUZLS48 SERIES CLAMPS

- For use with toughened or laminated glass • Sold by the pair • Black colour

CAT. NO.	THICKNESS	GLASS TYPE	1	50	100	500
EUZLS6GL	6mm	Toughened	£0.45	£0.41	£0.36	£0.32
EUZLS676GL	6.76mm	Laminated	£0.45	£0.41	£0.36	£0.32
EUZLS8GL	8mm	Toughened	£0.45	£0.41	£0.36	£0.32
EUZLS876GL	8.76mm	Laminated	£0.45	£0.41	£0.36	£0.32
EUZLS10GL	10mm	Toughened	£0.45	£0.41	£0.36	£0.32
EUZLS1076GL	10.76mm	Laminated	£0.45	£0.41	£0.36	£0.32
EUZLS12GL	12mm	Toughened	£0.45	£0.41	£0.36	£0.32
EUZLS1276GL	12.76mm	Laminated	£0.45	£0.41	£0.36	£0.32

*Minimum order: 1 pair. Price based on an order quantity of 500 pairs (CAT. NO. EUZLS6GL).

FROM ONLY
£0.32*
PER PAIR





COMMERCIAL HARDWARE

Get your copy now!

**CRL Office Partition
System Brochure**

CAT. NO. OPS15DEUK



Contact our technical advisers for more details on our office partition systems

CRL@crlaurence.co.uk or 00 800 0421 6144



CRL CLEAR GLASS JOINT SYSTEM 180° PARTITION STRIP

- Provides a clear slimline finish between two glass panels
- Excellent adhesion from pre-applied high bond tape
- 3m lengths

CAT. NO.	GLASS THICKNESS	GLASS TYPE	1	25	50
EZCC10	10mm	Toughened	£7.40	£6.75	£6.15
EZCC108	10.8mm	Laminated	£7.40	£6.75	£6.15
EZCC12	12mm	Toughened	£7.60	£7.00	£6.45
EZCC128	12.8mm	Laminated	£7.60	£7.00	£6.45

*Minimum order: 1 each. Price based on an order quantity of 50 (CAT. NO. EZCC10). Must ship common carrier.

FROM ONLY **£6.15***

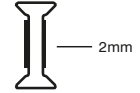

CRL CLEAR GLASS JOINT SYSTEM 90° CORNER PROTECTION STRIP

- Provides a clear slimline finish between two glass panels
- Excellent adhesion from pre-applied high bond tape
- 3m lengths

CAT. NO.	GLASS THICKNESS	GLASS TYPE	1	25	50
EZCL10	10mm	Toughened	£8.10	£7.35	£6.70
EZCL108	10.8mm	Laminated	£8.10	£7.35	£6.70
EZCL12	12mm	Toughened	£8.40	£7.60	£6.90
EZCL128	12.8mm	Laminated	£8.40	£7.60	£6.90

*Minimum order: 1 each. Price based on an order quantity of 50 (CAT. NO. EZCL10). Must ship common carrier.

FROM ONLY **£6.70***

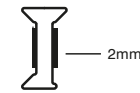

CRL CLEAR GLASS JOINT SYSTEM 3-WAY PARTITION STRIP

- Provides a clear slimline finish between two glass panels
- Excellent adhesion from pre-applied high bond tape
- 3m lengths

CAT. NO.	GLASS THICKNESS	GLASS TYPE	1	25	50
EZCT10	10mm	Toughened	£12.00	£10.85	£10.00
EZCT108	10.8mm	Laminated	£12.00	£10.85	£10.00
EZCT12	12mm	Toughened	£12.50	£11.25	£10.20
EZCT128	12.8mm	Laminated	£12.50	£11.25	£10.20

*Minimum order: 1 each. Price based on an order quantity of 50 (CAT.NO. EZCT10). Must ship common carrier.

FROM ONLY **£10.00***

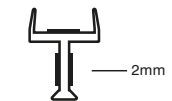

CRL CLEAR GLASS JOINT SYSTEM ABUTMENT STRIP

- Provides a clear slimline finish between two glass panels
- Excellent adhesion from pre-applied high bond tape
- 3m lengths

CAT. NO.	GLASS THICKNESS	GLASS TYPE	1	25	50
EZCE10	10mm	Toughened	£8.70	£8.05	£7.00
EZCE108	10.8mm	Laminated	£8.70	£8.05	£7.00
EZCE12	12mm	Toughened	£9.05	£8.30	£7.25
EZCE128	12.8mm	Laminated	£9.05	£8.30	£7.25

*Minimum order: 1 each. Price based on an order quantity of 50 (CAT. NO. EZCE10). Must ship common carrier.

FROM ONLY **£7.00***

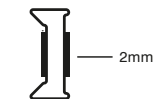
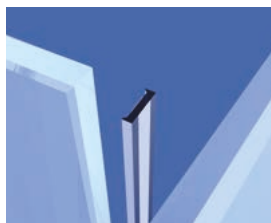



CRL CLEAR GLASS JOINT SYSTEM 180° IN-LINE 2-WAY PARTITION STRIP

- Clips over the glass joint
- 3m lengths
- Does not feature clear high bond tape

CAT. NO.	GLASS THICKNESS	GLASS TYPE	1	25	50
CLON10	10mm	Toughened	£6.15	£5.50	£5.10
CLON108	10.8mm	Laminated	£6.15	£5.50	£5.10
CLON12	12mm	Toughened	£6.75	£6.30	£5.75
CLON128	12.8mm	Laminated	£6.75	£6.30	£5.75

*Minimum order: 1 each. Price based on an order quantity of 50 (CAT. NO. CLON10). Must ship common carrier.

FROM ONLY **£5.10***

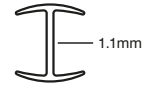

CRL CLEAR GLASS JOINT SYSTEM 90° 2-WAY PARTITION STRIP

- Clips over the glass joint
- Excellent adhesion from pre-applied clear high bond tape
- 3m lengths

CAT. NO.	GLASS THICKNESS	GLASS TYPE	1	25	50
CLON210	10mm	Toughened	£8.80	£8.05	£7.35
CLON2108	10.8mm	Laminated	£8.80	£8.05	£7.35
CLON212	12mm	Toughened	£9.55	£8.65	£7.90
CLON2128	12.8mm	Laminated	£9.55	£8.65	£7.90

*Minimum order: 1 each. Price based on an order quantity of 50 (CAT. NO. CLON210). Must ship common carrier.

FROM ONLY **£7.35***

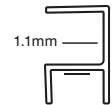

CRL CLEAR GLASS JOINT SYSTEM 90° 3-WAY PARTITION STRIP

- Clips over the glass joint
- Excellent adhesion from pre-applied clear high bond tape
- 3m lengths

CAT. NO.	GLASS THICKNESS	GLASS TYPE	1	25	50
CLON310	10mm	Toughened	£8.65	£7.85	£7.25
CLON3108	10.8mm	Laminated	£8.65	£7.85	£7.25
CLON312	12mm	Toughened	£9.35	£8.55	£7.80
CLON3128	12.8mm	Laminated	£9.35	£8.55	£7.80

*Minimum order: 1 each. Price based on an order quantity of 50 (CAT. NO. CLON310). Must ship common carrier.

FROM ONLY **£7.25***

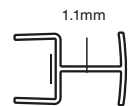

CRL CLEAR GLASS JOINT SYSTEM 135° 2-WAY PARTITION STRIP

- Clips over the glass joint
- Excellent adhesion from pre-applied clear high bond tape
- 3m lengths

CAT. NO.	GLASS THICKNESS	GLASS TYPE	1	25	50
CLON410	10mm	Toughened	£12.10	£10.95	£10.10
CLON4108	10.8mm	Laminated	£12.10	£10.95	£10.10
CLON412	12mm	Toughened	£12.95	£11.85	£10.85
CLON4128	12.8mm	Laminated	£12.95	£11.85	£10.85

*Minimum order: 1 each. Price based on an order quantity of 50 (CAT. NO. CLON410). Must ship common carrier.

FROM ONLY **£10.10***

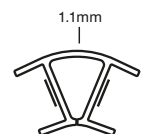
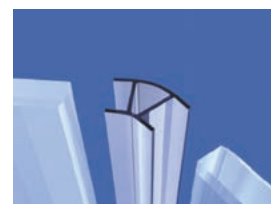



CRL GLASS MOUNTED LATCH WITH LOCK AND THUMBTURN

- Works on single or double doors
- Field reversible
- Glass fabrication required
- For 10 or 12mm glass
- 174mm overall length
- 304 Grade stainless steel
- Other finishes available
- Lever handles ordered separately, see our full line of handles at crlaurence.co.uk

CAT. NO.	FINISH	1	6
PTH311BS	Brushed Stainless	£52.75	£48.00

*Minimum order: 1 each. Price based on an order quantity of 6.
Price includes 10% discount. Special discount available from 1st January to 30th April 2017.

FROM ONLY
£48.00*

SAVE
10%



CRL PTH SERIES GLASS MOUNTED PATCH LOCK KEEPERS

- For 10 or 12mm glass
- Glass fabrication required
- Stamped body with finish cover plates included
- 304 grade stainless steel
- Over finishes available
- Work with CAT. NO. PTH311BS latch

CAT. NO.	FINISH	LENGTH	HEIGHT	1	6
PTH314BS	Brushed Stainless	174mm	74mm	£29.35	£26.40
PTH315BS	Brushed Stainless	70mm	74mm	£29.35	£26.40

*Minimum order: 1 each. Price based on an order quantity of 6 (CAT. NO. PTH314BS).
Price includes 10% discount. Special discount available from 1st January to 30th April 2017.

FROM ONLY
£26.40*

SAVE
10%



CAT. NO. PTH314BS

CAT. NO. PTH315BS

CRL T-STYLE DOOR PULL HANDLES

- Lengths from 300mm to 1 metre
- Also available in polished stainless
- Grade 304 brushed stainless steel
- Sold per pair
- Glass fabrication required

CAT. NO.	LENGTH	DIAMETER	1	5
EULP30019BS	300mm	19mm	£29.45	£22.05
EULP40019BS	400mm	19mm	£32.00	£24.05
EULP50019BS	500mm	25mm	£35.25	£26.40
EULP60032BS	600mm	32mm	£40.60	£30.45
EULP100032BS	1000mm	32mm	£66.85	£50.15

*Minimum order: 1 pair. Price based on an order quantity of 5 pairs (CAT. NO. EULP30019BS).
Price includes 10% discount. Special discount available from 1st January to 30th April 2017.

FROM ONLY
£22.05*
PER PAIR

SAVE
10%



CRL EUR SERIES COMPLETE PATCH LOCK INCLUDING CYLINDER

- Can be mounted on top, bottom or side of doors
- High density cast body with lock mechanism
- For 10 or 12mm glass
- Bottom load cylinder
- Glass fabrication required
- Keepers ordered separately, for more details go to crlaurence.co.uk

CAT. NO.	FINISH	1	6
EUR205BS	Brushed Stainless	£44.45	£40.00

*Minimum order: 1 each. Price based on an order quantity of 6.
Price includes 10% discount. Special discount available from 1st January to 30th April 2017.

FROM ONLY
£40.00*

SAVE
10%





CRL CENTRE-HUNG FREE SWINGING TOP PIVOT

- Surface mount top pivot for use with patch fittings and CRL WEDGE-LOCK® Door Rail System
- Installs easily to wood or metal substrates

FROM ONLY **£2.60***

SAVE **10%**



CAT. NO.	DESCRIPTION	1	6
1NT401	Centre-Hung Free Swinging Top Pivot	£2.95	£2.60

*Minimum order: 1 each. Price based on an order quantity of 6. Price includes 10% discount. Special discount available from 1st January to 30th April 2017.

CRL ADJUSTABLE POWER 180° FLOOR MOUNTED DOOR CLOSER

- The perfect door closer to support CRL's patch hardware
- Interchangeable spindle heights
- 120kg capacity, 1067mm wide doors
- Narrow 82mm width cement box
- EN3 medium strength floor spring
- Complete with cement box, brushed stainless cover plate and standard height spindle (other heights ordered separately)

FROM ONLY **£96.95***

SAVE **5%**

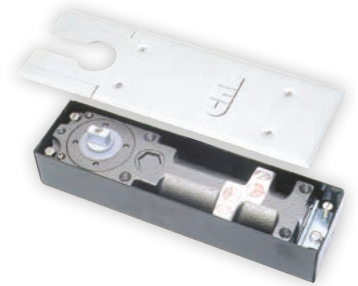

CAT. NO.	DESCRIPTION	1	6	48	96
EUCRL8460V	Adjustable Floor Mounted Closer	£114.00	£108.35	£101.55	£96.95

*Minimum order: 1 each. Price based on an order quantity of 96. Price includes 5% discount. Special discount available from 1st January to 30th April 2017.

CRL DOOR PATCH FITTING WITH INSERT

- 65mm pivot setback
- For 10 or 12mm glass
- Glass fabrication required, see more details online at crlaurence.co.uk

SAVE **10%**

FROM ONLY **£17.65***

CAT. NO.	DESCRIPTION	FINISH	INSERT	1	6
PH21ABS	Top door patch fitting	Brushed Stainless	1NT303	£19.65	£17.65
PH21APS	Top door patch fitting	Polished Stainless	1NT303	£19.65	£17.65
PH11CBS	Bottom door patch fitting	Brushed Stainless	1NT301	£22.65	£20.15
PH11CPS	Bottom door patch fitting	Polished Stainless	1NT301	£22.65	£20.15

*Minimum order: 1 each. Price based on an order quantity of 6 (CAT. NO. PH21ABS). Price includes 10% discount. Special discount available from 1st January to 30th April 2017.



CRL TRANSOM PATCH WITH INSERT

- Works with both 65 and 70mm pivot setback door patch fittings
- Used to support a transom from a side jamb
- For 10 or 12mm glass
- Glass fabrication required, see more details online at crlaurence.co.uk

FROM ONLY **£19.00***

SAVE **10%**

CAT. NO.	DESCRIPTION	FINISH	INSERT	1	6
PH34BS	Wall mounted transom patch	Brushed Stainless	1NT300	£21.10	£19.00
PH34PS	Wall mounted transom patch	Polished Stainless	1NT300	£21.10	£19.00
PH40BS	Sidelite mounted transom patch	Brushed Stainless	1NT300	£37.35	£33.55
PH40PS	Sidelite mounted transom patch	Polished Stainless	1NT300	£37.35	£33.55

*Minimum order: 1 each. Price based on an order quantity of 6 (CAT. NO. PH34BS). Price includes 10% discount. Special discount available from 1st January to 30th April 2017.





CRL OIL DYNAMIC HINGES FOR GLASS DOORS

CONFORMS TO
EN1154:2006

CRL OIL DYNAMIC WALL-TO-GLASS HINGE

- Adjustable closing speed
- Swings in and out a full 90 degrees, with stops at 0°, +90°, and -90°
- Also available in no-hold open option
- 100kg max door weight
- 1000mm max door width
- For 8 to 13.52mm toughened glass

SAVE
10%FROM ONLY
£89.00*

CRL OIL DYNAMIC OFFSET WALL-TO-GLASS HINGE

- Adjustable closing speed
- Swings in and out a full 90 degrees, with stops at 0°, +90°, and -90°
- Also available in no-hold open option
- 100kg max door weight
- 1000mm max door width

SAVE
10%FROM ONLY
£89.00*

CRL OIL DYNAMIC GLASS-TO-GLASS HINGE

- Adjustable closing speed
- Swings in and out a full 90 degrees, with stops at 0°, +90°, and -90°
- Also available in no-hold open option
- 80kg max door weight
- 1000mm max door width
- For 8 to 13.52mm toughened glass

SAVE
10%FROM ONLY
£120.00*

CAT. NO.	DESCRIPTION	FINISH	1	6
31M8010SN	Wall-to-Glass Hinge	Satin Nickel	£104.00	£96.00
31M8010SA	Wall-to-Glass Hinge	Satin Anodised	£96.40	£89.00
31M8010CH	Wall-to-Glass Hinge	Polished Chrome	£96.40	£89.00

NO HOLD OPEN OPTION

31M8210SN	Wall-to-Glass Hinge	Satin Nickel	£103.95	£95.95
31M8210SA	Wall-to-Glass Hinge	Satin Anodised	£96.40	£89.00
31M8210CH	Wall-to-Glass Hinge	Polished Chrome	£96.40	£89.00

CLAD OPTION

31M8010CBS	Wall-to-Glass Hinge	Brushed Stainless	£103.95	£95.95
31M8010CPS	Wall-to-Glass Hinge	Polished Stainless	£109.35	£100.90

FOR HIGH HUMIDITY RESISTANCE IN DAMP ENVIRONMENTS

31M8010BTSN	Wall-to-Glass Hinge	Satin Nickel	£112.25	£103.65
31M8010BTSA	Wall-to-Glass Hinge	Satin Anodised	£104.70	£96.65
31M8010BTCH	Wall-to-Glass Hinge	Polished Chrome	£104.70	£96.65

*Minimum order: 1 each. Price based on an order quantity of 6 (CAT. NO. 31M8010CH). Price includes 10% discount. Special discount available from 1st January to 30th April 2017. All Oil Dynamic Hinges can be combined for quantity pricing.

CAT. NO.	DESCRIPTION	FINISH	1	6
31M8011SN	Offset Wall-to-Glass Hinge	Satin Nickel	£103.95	£95.95
31M8011SA	Offset Wall-to-Glass Hinge	Satin Anodised	£105.25	£96.45
31M8011CH	Offset Wall-to-Glass Hinge	Polished Chrome	£105.25	£96.45

NO HOLD OPEN OPTION

31M8211SN	Offset Wall-to-Glass Hinge	Satin Nickel	£103.95	£95.95
31M8211SA	Offset Wall-to-Glass Hinge	Satin Anodised	£96.45	£89.00
31M8211CH	Offset Wall-to-Glass Hinge	Polished Chrome	£96.45	£89.00

FOR HIGH HUMIDITY RESISTANCE IN DAMP ENVIRONMENTS

31M8011BTSN	Offset Wall-to-Glass Hinge	Satin Nickel	£112.25	£103.65
31M8011BTSA	Offset Wall-to-Glass Hinge	Satin Anodised	£104.70	£96.65
31M8011BTCH	Offset Wall-to-Glass Hinge	Polished Chrome	£104.70	£96.65

*Minimum order: 1 each. Price based on an order quantity of 6 (CAT. NO. 31M8211CH). Price includes 10% discount. Special discount available from 1st January to 30th April 2017. All Oil Dynamic Hinges can be combined for quantity pricing.

CAT. NO.	DESCRIPTION	FINISH	1	6
31M8015SN	Glass-to-Glass Hinge	Satin Nickel	£144.00	£132.90
31M8015SA	Glass-to-Glass Hinge	Satin Anodised	£130.00	£120.00
31M8015CH	Glass-to-Glass Hinge	Polished Chrome	£130.00	£120.00

NO HOLD OPEN OPTION

31M8215SN	Glass-to-Glass Hinge	Satin Nickel	£144.00	£132.90
31M8215SA	Glass-to-Glass Hinge	Satin Anodised	£130.00	£120.00
31M8215CH	Glass-to-Glass Hinge	Polished Chrome	£130.00	£120.00

CLAD OPTION

31M8015CBS	Glass-to-Glass Hinge	Brushed Stainless	£144.00	£132.90
31M8015CPS	Glass-to-Glass Hinge	Polished Stainless	£149.35	£137.85

FOR HIGH HUMIDITY RESISTANCE IN DAMP ENVIRONMENTS

31M8015BTSN	Glass-to-Glass Hinge	Satin Nickel	£152.25	£140.55
31M8015BTSA	Glass-to-Glass Hinge	Satin Anodised	£138.30	£127.65
31M8015BTCH	Glass-to-Glass Hinge	Polished Chrome	£138.30	£127.65

*Minimum order: 1 each. Price based on an order quantity of 6 (CAT. NO. 31M8015CH). Price includes 10% discount. Special discount available from 1st January to 30th April 2017. All Oil Dynamic Hinges can be combined for quantity pricing.





CRL OIL DYNAMIC REBATED WALL-TO-GLASS HINGE

- Adjustable closing speed
- For use with rebated door frames
- Swings out 90 degrees
- Stops at 90 degrees
- Hold open
- 100kg max door weight
- 1000mm max door width
- For 8 to 12mm toughened glass



SAVE 10%

FROM ONLY **£86.40***

CAT. NO.	DESCRIPTION	FINISH	1	6
31M8060SN	Wall-to-Glass Hinge	Satin Nickel	£103.95	£95.95
31M8060CH	Wall-to-Glass Hinge	Polished Chrome	£96.45	£89.00

NO HOLD OPEN OPTION

31M8260SN	Wall-to-Glass Hinge	Satin Nickel	£103.95	£95.95
31M8260CH	Wall-to-Glass Hinge	Polished Chrome	£93.60	£86.40

*Minimum order: 1 each. Price based on an order quantity of 6 (CAT. NO. 31M8260CH). Price includes 10% discount. Special discount available from 1st January to 30th April 2017. All Oil Dynamic Hinges can be combined for quantity pricing.

CRL OIL DYNAMIC PATCH FITTING CLOSER WITH BACK CHECK

The CRL Oil Dynamic Patch Fitting Door Closer is an innovative patch fitting for installation on interior doors. The self-closing patch fitting is designed for installation without the need for a floor box, and is extremely quick and easy to install on to any floor. The patch fittings do not require any additional floor or overhead closing devices, yet maintain the advantages of a closing system. The closing speed is adjustable.

- Closing speed can be adjusted
- Swings in and out a full 90 degrees. with stops at 0°, +90°, and -90°.
- Also available in no-hold open option
- 100kg max door weight
- 1000mm max door width
- For 8 to 13.52mm toughened glass
- Matching top patch fittings available



SAVE 10%

FROM ONLY **£154.00***

CAT. NO.	DESCRIPTION	FINISH	1	6
----------	-------------	--------	---	---

BOTTOM PATCH FITTING WITH BACK CHECK

31M100E10	Body of patch closer. excludes cover		£166.50	£154.00
-----------	--------------------------------------	--	---------	---------

WITHOUT BACK CHECK

31M100E10NB	Body of patch closer. excludes cover		£171.35	£157.10
-------------	--------------------------------------	--	---------	---------

NO HOLD OPEN OPTION

31M100E10NHO	Body of patch closer. excludes cover		£214.15	£196.40
--------------	--------------------------------------	--	---------	---------

CLAD OPTIONS**

31M100E10COVBS	Cover for patch closer	Brushed Stainless	£13.70	£12.55
31M100E10COVPS	Cover for patch closer	Polished Stainless	£14.75	£13.55
31M100E10COVSA	Cover for patch closer	Satin Anodised	£11.95	£11.05

TOP PATCH FITTING

31M100E20	Matching top patch fitting		£43.30	£39.65
-----------	----------------------------	--	--------	--------

*Minimum order: 1 each. Price based on an order quantity of 6 (CAT. NO. 31M100E10). Price includes 10% discount. Special discount available from 1st January to 30th April 2017. All Oil Dynamic Hinges can be combined for quantity pricing.

**Clad options fit top and bottom patch fittings.

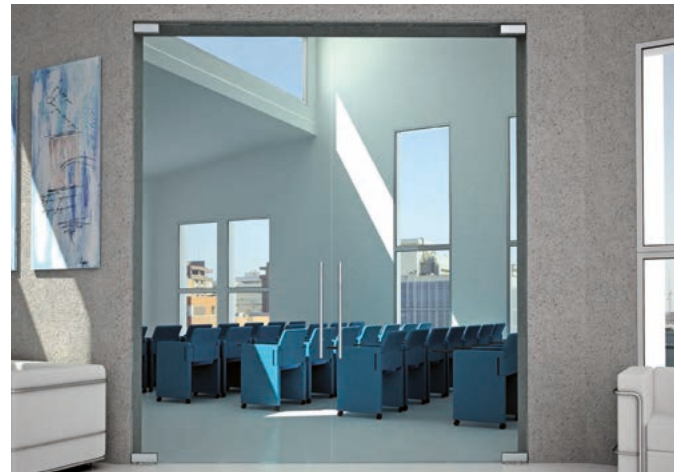

European HQ



Manchester | Charles Babbage Avenue, Kingsway Business Park, Rochdale, OL16 4NW, England

Germany



Stuttgart | Boschstrasse 7 D-74360 Ilsfeld, Germany

Denmark



Copenhagen | Stamholmen 70 Unit B, DK-2650 Hvidovre, Denmark

The Complete Collection

EUAB12UK for the Binder with the following selection of brochures:

- EUTL14 TAPER-LOC® Frameless Glass Balustrade System
- DH12UK Door Hardware & Partitioning Systems for Glass
- RS12UK Aluminium Railing & Windscreen Systems
- GA14DEUK Glass Awnings Brochure
- SDH12UK Shower Door Hardware
- OPS15DEUK Office Partition System
- CXUKDEFR15 Compact-X Sliding Door System
- CAB0UK14 Cabo Soft Close Shower Door System

EUAB12 for the Binder only

For your copy call: **00 800 0421 6144** or email: **CRL@crlaurence.co.uk**

The ring binder enables you to add new brochures as they are published.



For more information Freephone 00 800 0421 6144 (UK & Europe) | Freefax 00 800 0262 3299

