

**CRL**<sup>®</sup>  
A CRH COMPANY

# Great Deals

HURRY - ENDS 30TH SEPTEMBER 2021

## Paris Balconies

See Page 4



For all the latest offers,  
sign up to our newsletter  
at [crlnews.co.uk](https://crlnews.co.uk)





# Juliette Balconies

## CRL Juliette Balcony Connector

- For use with the 48.3 mm EUGR20 Cap Rail
- 316 Grade Stainless Steel
- Tested to a width of 2400 mm certificate available
- Single pane of glass must be used for all widths of Juliette Balconies when using these products

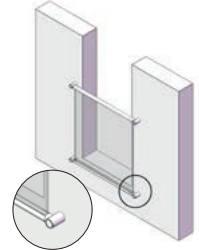
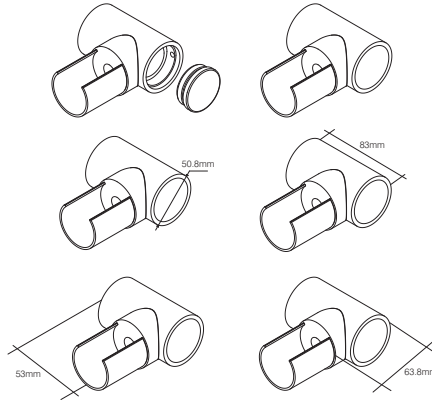

Cat. No.	Finish	1	10
<b>EUGR20JBS</b>	Brushed Stainless Steel	£58.92	£55.66
<b>EUGR20JPS</b>	Polished Stainless Steel	£59.97	£57.28

\*Minimum order: 1 each. Price based on an order quantity of 10 (EUGR20JBS).

~~WAS £59.00~~  
**NOW FROM ONLY**  
**£55.66\***  
 EACH

## 48.3 mm Diameter Cap Rail

- For 12 mm to 25.52 mm glass
- Connects to a variety of fabricated corners and end caps

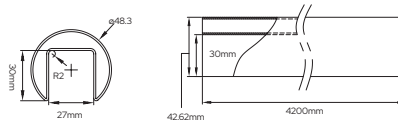

~~WAS £47.65~~  
**NOW FROM ONLY**  
**£45.21\***  
 EACH

Cat. No.	Finish	Length	1	6
<b>EUGR20BS</b>	Brushed Stainless Steel	3 m	£46.11	£45.21
<b>EUGR20BS14</b>	Brushed Stainless Steel	4.2 m	£64.34	£60.33
<b>EUGR20PS</b>	Polished Stainless Steel	3 m	£83.87	£78.52
<b>EUGR20PS14</b>	Polished Stainless Steel	4.2 m	£117.18	£109.87

\*Minimum order: 1 length. Price based on an order quantity of 6 (EUGR20BS).

Glass Thickness



12 mm to 25.52 mm



# Paris Balconies

## CRL Fascia Mount Paris Balcony System

- Height 1,200 mm
- Fixes to brickwork, concrete and steel
- Tempered laminated glass
- Tested to BS6180:2011
- Substrate fixings not included
- Profiles can be cut to size on site

~~WAS £115.73~~  
**NOW FROM ONLY**  
**£93.63\***  
 EACH

Cat. No.	Glass Thickness	Colour	Max Span	1	5
<b>PARIS1GR</b>	13.52 & 17.52 mm	Grey RAL 7016	13.52 mm = 1,620 mm, 17.52 mm = 2,150 mm	£99.88	£93.63
<b>PARIS1W</b>	13.52 & 17.52 mm	White RAL 9016	13.52 mm = 1,620 mm, 17.52 mm = 2,150 mm	£99.88	£93.63
<b>PARIS2GR</b>	21.52 mm	Grey RAL 7016	2,600 mm	£106.37	£94.28
<b>PARIS2W</b>	21.52 mm	White RAL 9016	2,600 mm	£106.37	£94.28

\*Minimum order: 1 length. Price based on an order quantity of 5 (PARIS1GR).

## CRL Reveal Mount Paris Balcony System

- Height 1,200 mm
- Fixes to brickwork, concrete and steel
- Tempered laminated glass
- Tested to BS6180:2011
- Substrate fixings not included
- Profiles can be cut to size on site

~~WAS £110.62~~  
**NOW FROM ONLY**  
**£94.74\***  
 EACH

Cat. No.	Glass Thickness	Colour	Max Span	1	5
<b>PARIS3GR</b>	13.52 & 17.52 mm	Grey RAL 7016	13.52 mm = 1,620 mm, 17.52 mm = 2,150 mm	£103.16	£94.74
<b>PARIS3W</b>	13.52 & 17.52 mm	White RAL 9016	13.52 mm = 1,620 mm, 17.52 mm = 2,150 mm	£103.16	£94.74
<b>PARIS4GR</b>	21.52 mm	Grey RAL 7016	2,600 mm	£103.16	£94.74
<b>PARIS4W</b>	21.52 mm	White RAL 9016	2,600 mm	£103.16	£94.74

\*Minimum order: 1 length. Price based on an order quantity of 5.







For interior and exterior applications

## CRL Posiglaze Surface Mount Base Shoe



**For a standard 3 m surface mount installation, the following components will be required:**

- 1 x 3 m Surface Mount Base Shoe
- 2 x 3 m Top Clip
- 1 x Clamp kit to suit specified glass thickness
- 1 x Spanner

## CRL Posiglaze Surface Mount Base Shoe

- For use with 12 to 21.52 mm glass
- Pre-drilled first hole from edge of base shoe: 100 mm
- Pre-drilled centre-to-centre hole distance: 200 mm
- Hole suited to 12 mm fixing bolt and counter bored to sink the bolt head
- 3 m length

WAS £180.25

NOW FROM ONLY

**£170.98\***

EACH



Cat. No.	Description	Finish	1	6
EPGDSV	Surface Mount Base Shoe	Steel Anodised	£182.31	£170.98

\*Minimum order: 1 each. Price based on an order quantity of 6.

## CRL Posiglaze Top Clip

- Holds the gasket
- Presses onto the channel at the end of the installation
- Covers the clamps from and prevents debris from entering the channel
- 3 m length

WAS £12.88

NOW FROM ONLY

**£11.75\***

EACH



Cat. No.	Description	1	6
EPGTSSV	Top Clip	£12.29	£11.75

\*Minimum order: 1 each. Price based on an order quantity of 6.

## CRL Posiglaze Clamp Kits (inc. clamps, gasket, bars, bolts)

- Includes enough components to suit a 3 m length of base shoe
- Glass clamps have a  $\pm 1$  mm tolerance to accommodate varying interlayer thicknesses in the glass
- Includes the clamp bars which sit into the top mould of the clamps and the clamp bolts which screw into the bars and are then undone to hold the glass in place. These are undone and tightened each side allowing the glass alignment
- Includes 6 m gasket to suit glass thickness



WAS £50.37

NOW FROM ONLY

**£47.01\***

EACH

Cat. No.	Description	1	6
EPG21SET	Clamp Kits for 12 mm glass	£50.43	£47.01

\*Minimum order: 1 each. Price based on an order quantity of 6.

## CRL Posiglaze Spanner

- With angle to reach the clamp to tighten/loosen the glass
- Material: Steel

WAS £5.83

NOW FROM ONLY

**£5.54\***

EACH



Cat. No.	Description	1	6
EPGSPAN	Spanner	£5.95	£5.54

\*Minimum order: 1 each. Price based on an order quantity of 6.



For interior and exterior applications

# CRL Pre Assembled Post Railing System

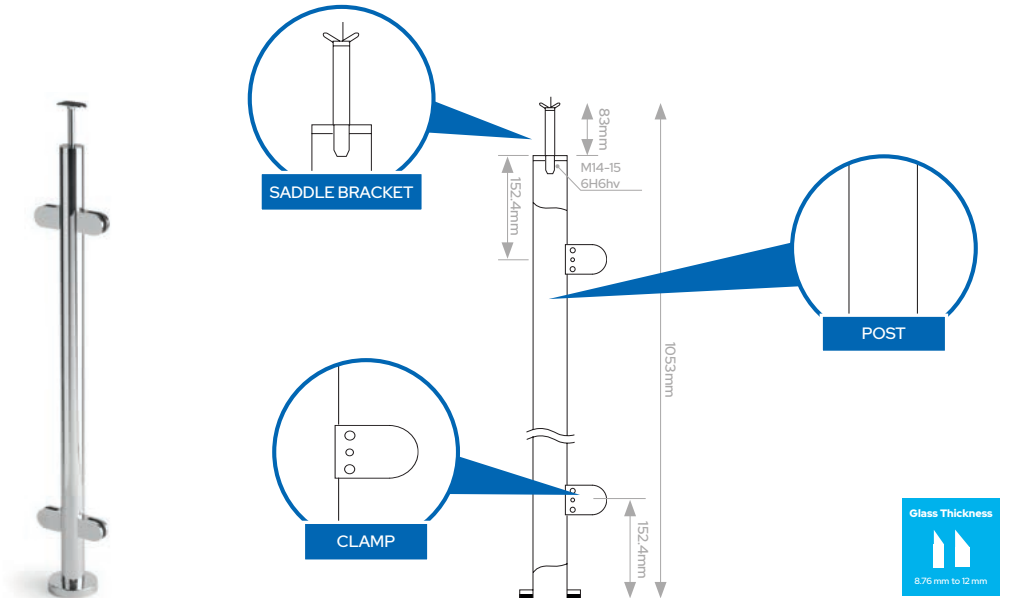



## 50.8mm Post Kits and Accessories

- 50.8 mm post kits
- 316 grade stainless steel
- Sold as a complete post kit
- For 8.76 mm, 10 mm, 10.76 mm and 12 mm
- Available in brushed and polished stainless steel
- No clamps provided
- 2.5 mm material thickness

Save time & money

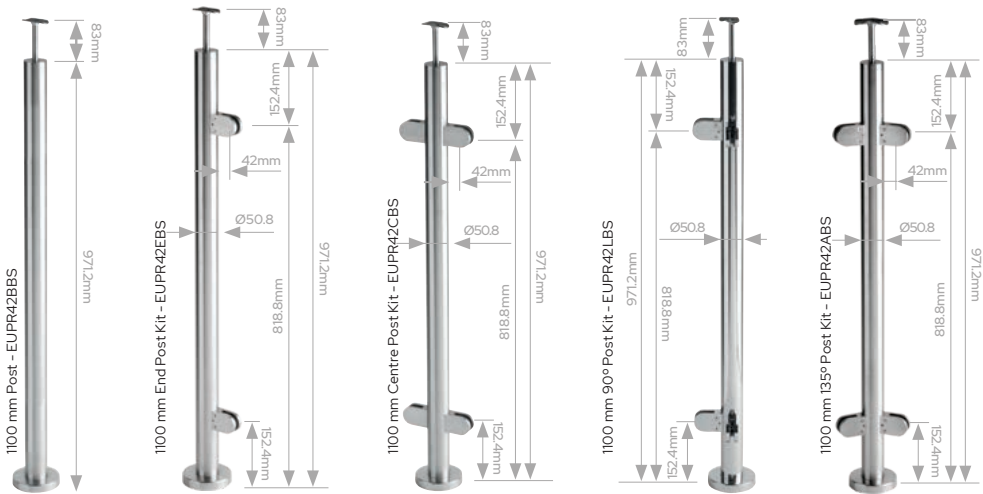

Cat. No.	Description	Finish	1	6
EUPR42BBS	1100 mm Post	Brushed Stainless Steel	£66.33	£61.76
EUPR42EBS	1100 mm End Post Kit	Brushed Stainless Steel	£87.01	£80.91
EUPR42EPS	1100 mm End Post Kit	Polished Stainless Steel	£91.81	£85.48
EUPR42CBS	1100 mm Centre Post Kit	Brushed Stainless Steel	£102.28	£96.89
EUPR42CPS	1100 mm Centre Post Kit	Polished Stainless Steel	£108.79	£101.16
EUPR42LBS	1100 mm 90° Post Kit	Brushed Stainless Steel	£105.57	£98.41
EUPR42LPS	1100 mm 90° Post Kit	Polished Stainless Steel	£110.54	£103.04
EUPR42ABS	1100 mm 135° Post Kit	Brushed Stainless Steel	£128.65	£120.08
EUPR42APS	1100 mm 135° Post Kit	Polished Stainless Steel	£128.78	£120.47

\* Minimum order: 1 each. Price based on an order quantity of 6 (EUPR42BBS).

~~WAS £66.69~~  
**NOW FROM ONLY**  
**£61.76\***  
**EACH**

### 3 m Hand Rail Tubing

- For 50.8 mm post kits
- Sold per 3 metre length
- Used with European post kits
- Two architectural finishes
- 1.2 mm material thickness
- 316 grade stainless steel
- Available in brushed and polished stainless steel

~~WAS £50.45~~  
**NOW FROM ONLY**  
**£47.06\***  
 EACH



Cat. No.	Finish	1	6
<b>EUHR20BS</b>	Brushed Stainless Steel	£51.12	£47.06
<b>EUHR20PS</b>	Polished Stainless Steel	£54.42	£51.12

\*Minimum order: 1 length. Price based on an order quantity of 6 (EUHR20BS).

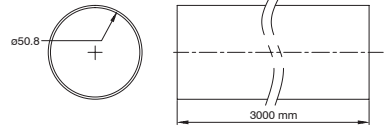

### Internal Connector

- For 50.8 mm post kits
- Used with handrail tubing
- 316 grade stainless steel

~~WAS £8.28~~  
**NOW FROM ONLY**  
**£7.65\***  
 EACH



Cat. No.	Finish	1	6
<b>EUHR20CSS</b>	Brushed Stainless Steel	£8.21	£7.65

\*Minimum order: 1 each. Price based on an order quantity of 6.

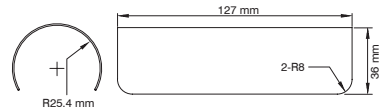

### 90° Corner

- For 50.8 mm post kits
- Used with European post kits
- 316 grade stainless steel
- Sold individually

~~WAS £12.41~~  
**NOW FROM ONLY**  
**£11.47\***  
 EACH



Cat. No.	Finish	1	6
<b>EUHR20HBS</b>	Brushed Stainless Steel	£12.31	£11.47
<b>EUHR20HPS</b>	Polished Stainless Steel	£13.41	£12.51

\*Minimum order: 1 each. Price based on an order quantity of 6 (EUHR20HBS).

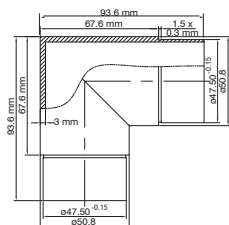

## End Cap

- For 50.8 mm post kits
- Used with handrail tubing
- 316 grade stainless steel
- Sold individually

WAS £4.92  
NOW FROM ONLY  
**£4.56\***  
EACH

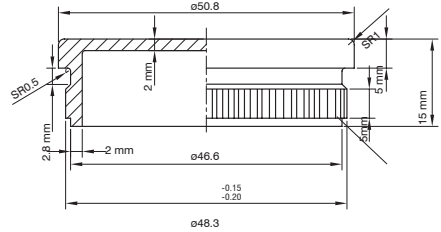

Cat. No.	Finish	1	6
EUHR20ECBS	Brushed Stainless Steel	£4.89	£4.56
EUHR20ECPs	Polished Stainless Steel	£5.36	£5.01

\*Minimum order: 1 each. Price based on an order quantity of 6 (EUHR20ECBS).

## Securing End Cap

- For 50.8 mm post kits
- Used with handrail tubing
- 316 grade stainless steel
- Sold individually

WAS £5.78  
NOW FROM ONLY  
**£5.41\***  
EACH

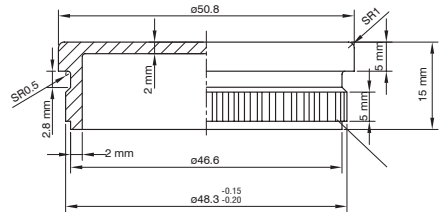

Cat. No.	Finish	1	6
EUHR20SECBS	Brushed Stainless Steel	£5.68	£5.41
EUHR20SECPs	Polished Stainless Steel	£6.79	£6.43

\*Minimum order: 1 each. Price based on an order quantity of 6 (EUHR20SECBS).

## CRL Full Flange

- For 50.8 mm tubing
- 316 grade stainless steel

WAS £11.06  
NOW FROM ONLY  
**£10.05\***  
EACH

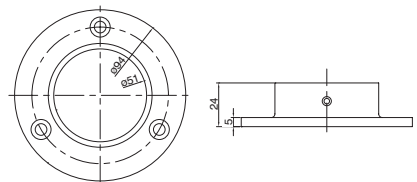

Cat. No.	Finish	1	10
EUHR20YBS	Brushed Stainless Steel	£10.96	£10.05
EUHR20YPS	Polished Stainless Steel	£11.21	£10.27

\*Minimum order: 1 each. Price based on an order quantity of 10 (EUHR20YBS).



## CRL PPS Series Portable Partition Screen fitting

- Support for Tempered or Laminated Glass or Acrylic screens
- Adjustable thickness 6 mm – 10 mm
- Anti-slip base
- Recommended: 2 Fittings / metre, 3 Fittings / 1.5 metre

FROM ONLY  
**£18.69\***  
EACH

PPS1000  
Screen Height  
100 cm

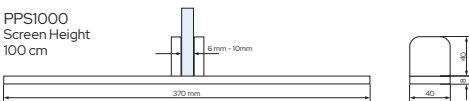

PPS800  
Screen Height  
80 cm

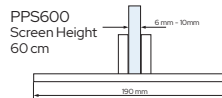
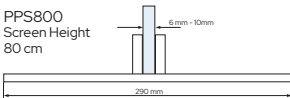

PPS600  
Screen Height  
60 cm

Cat. No.	Screen Height	Finish	1	10	40
PPS600MBL	Up to Max 600 mm	Matte Black	£22.09	£20.25	£18.69
PPS600BS	Up to Max 600 mm	Brushed Stainless	£23.73	£21.75	£20.07
PPS800MBL	Up to Max 800 mm	Matte Black	£25.33	£23.22	£21.43
PPS800BS	Up to Max 800 mm	Brushed Stainless	£26.51	£24.31	£22.43
PPS1000MBL	Up to Max 1000 mm	Matte Black	£27.25	£24.98	£23.06
PPS1000BS	Up to Max 1000 mm	Brushed Stainless	£27.70	£25.39	£23.44

\*Minimum order: 1 each. Price based on an order quantity of 40 (PPS600MBL).

## CRL Large D Shape Flat Back Glass Clamp

- For use on mezzanines, partitions, railings and windbreaks
- For 8 to 12.76 mm toughened or laminated glass
- Steel pin included for additional glass support
- Size 63 x 45 x 30 mm
- Sold individually
- Matching flat rubber gaskets available, sold as a pair

Also available in radius back. Other gaskets available for other glass thicknesses

WAS £2.04  
NOW FROM ONLY  
**£1.96\***  
EACH



Cat. No.	Description	Finish	Glass Thickness	For Use	1	50	100	500	1000
<b>EUZFBBN</b>	Large D Shape Flat Back Glass Clamp	Brushed Nickel	-	Internally	£3.23	£2.94	£2.69	£2.39	£2.16
<b>EUZFBCH</b>	Large D Shape Flat Back Glass Clamp	Chrome	-	Internally	£3.28	£2.98	£2.73	£2.41	£2.18
<b>EUZFBZ</b>	Large D Shape Flat Back Glass Clamp	Raw Zinc	-	Internally	£2.64	£2.37	£2.20	£2.00	-
<b>EUZFBMBL</b>	Large D Shape Flat Back Glass Clamp	Matt Black	-	Internally	£2.74	£2.49	£2.28	£2.10	£1.96
<b>EUZFBBS</b>	Large D Shape Flat Back Glass Clamp	Brushed Stainless	-	Externally	£5.57	£5.16	£4.80	£4.50	-
<b>EUZFBPS</b>	Large D Shape Flat Back Glass Clamp	Polished Stainless	-	Externally	£7.41	£6.85	£6.38	£5.96	-
<b>EUZ8G</b>	Rubber Gaskets	-	8 mm	-	£0.25	£0.24	£0.23	£0.21	£0.20
<b>EUZ10G</b>	Rubber Gaskets	-	10 mm	-	£0.25	£0.24	£0.23	£0.21	£0.20

\*Minimum order: 1 each. Price based on an order quantity of 1000 (EUZFBMBL).

## CRL Square Type Flat Back Glass Clamps

- For use on mezzanines, partitions, railings and windbreaks
- For 6 to 10.76 mm glass
- Safety pin not included
- Size 45 x 45 x 27 mm
- Sold individually
- Matching flat rubber gaskets available, sold as a pair

Also available in radius back. Other gaskets available for other glass thicknesses

WAS £1.70  
NOW FROM ONLY  
**£1.56\***  
EACH



Cat. No.	Description	Finish	Glass Thickness	For Use	1	50	100	500
<b>EUZSFBBN</b>	Square Type Flat Back Glass Clamp	Brushed Nickel	-	Internally	£2.87	£2.66	£2.48	£2.39
<b>EUZSFZ</b>	Square Type Flat Back Glass Clamp	Raw Zinc	-	Internally	£2.01	£1.84	£1.69	£1.56
<b>EUZSFBS</b>	Square Type Flat Back Glass Clamp	Brushed Stainless	-	Internally	£5.45	£4.85	£4.36	£4.19
<b>EUZSFBPS</b>	Square Type Flat Back Glass Clamp	Polished Stainless	-	Internally	£6.64	£5.90	£5.30	£4.82
<b>EUZS8G</b>	Rubber Gaskets	-	8 mm	-	£0.27	£0.25	£0.23	£0.21
<b>EUZS10G</b>	Rubber Gaskets	-	10 mm	-	£0.27	£0.25	£0.23	£0.21

\* Minimum order: 1. Price based on an order quantity of 500 (EUZSFZ).

## CRL Large Square Type Flat Back Glass Clamps

- For use on mezzanines, partitions, railings and windbreaks
- For 6 to 12.76 mm toughened or laminated glass
- Safety pin included
- Side plates for use with laminated glass
- Size 55 x 55 x 35 mm
- Sold individually
- Matching flat rubber gaskets available, sold as a pair

Also available in radius back. Other gaskets available for other glass thicknesses

WAS £2.82  
NOW FROM ONLY  
**£2.50\***  
EACH



Cat. No.	Description	Finish	Glass Thickness	For Use	1	50	100	500
<b>EUZLSFBBSL</b>	Large Square Type Flat Back Glass Clamp	Brushed Stainless	-	Externally	£12.12	£11.52	£10.24	£9.22
<b>EUZLSFBZL</b>	Large Square Type Flat Back Glass Clamp	Raw Zinc	-	Externally	£3.32	£2.96	£2.65	£2.50
<b>EUZLS8GL</b>	Rubber Gaskets	-	8 mm	-	£0.40	£0.37	£0.34	£0.30
<b>EUZLS10GL</b>	Rubber Gaskets	-	10 mm	-	£0.40	£0.37	£0.34	£0.30

\* Minimum order: 1. Price based on an order quantity of 500 (EUZLSFBZL).



## CRL Wall Mount Brackets

- Component to provide fixed panel support for enclosures not going to the ceiling
- Compatible with CRL support bars
- Chrome finish

~~WAS £5.15~~  
**NOW FROM ONLY**  
**£4.45\***  
 EACH



Cat. No.	Description	1	6
<b>SQ46CH</b>	Square Wall Mount Bracket	£7.90	£7.15
<b>SQJ46CH</b>	Square Slimline Wall Mount Bracket	£5.53	£4.97
<b>S12CH</b>	Round Wall Mount Bracket	£4.91	£4.45

\*Minimum order: 1. Price based on an order quantity of 6 (S12CH).

## CRL Brackets

- For use with 6 to 8 mm glass
- Component to provide fixed panel support for enclosures not going to the ceiling
- No hole required in the glass
- Chrome finish

~~WAS £8.78~~  
**NOW FROM ONLY**  
**£7.67\***  
 EACH

Cat. No.	Description	1	6
<b>SQ41CH</b>	Swivelling U-Bracket	£12.92	£12.01
<b>SQJ41CH</b>	Swivelling Slimline U-Bracket	£8.18	£7.67
<b>S4VCH</b>	Round Swivelling Stabiliser	£11.55	£10.49

\*Minimum order: 1. Price based on an order quantity of 6 (SQJ41CH).



## CRL Support Bars

- Component to provide fixed panel support for enclosures not going to the ceiling
- Compatible with a large range of CRL brackets to meet your needs
- Chrome finish

~~WAS £16.86~~  
**NOW FROM ONLY**  
**£15.13\***  
 EACH

Cat. No.	Description	Size	1	6
<b>S1CH</b>	1 m Round Support Bar	19 mm	£16.34	£15.13
<b>S2CH</b>	1,295 mm Round Support Bar	19 mm	£21.21	£19.19
<b>SQ39CH</b>	1 m Square Support Bar	19 mm	£27.94	£26.00
<b>SQJ39CH</b>	1 m Square Slimline Support Bar	15 mm	£28.66	£26.20

\*Minimum order: 1. Price based on an order quantity of 6 (S1CH).



## CRL Aluminium U-Channel for 6 to 8mm Glass

- Available in 2.49 m lengths
- Wet glaze with clear silicone
- Extremely versatile extrusion in up to 5 popular finishes - see crlaurence.co.uk

~~WAS £9.43~~  
**NOW FROM ONLY**  
**£8.49\***  
 EACH

Cat. No.	Finish	1	10	40	80	120
<b>SDCD516BA</b>	Bright Anodised	£11.32	£10.29	£9.43	£8.71	£8.49
<b>SDCD516BN</b>	Brushed Nickel	£11.18	£10.24	£9.46	£9.22	£8.79
<b>SDCD516MBL</b>	Matte Black	£25.61	£21.33	£18.28	£16.01	£14.23

\*Minimum order: 1 each. Price based on an order quantity of 120 (SDCD516BA).

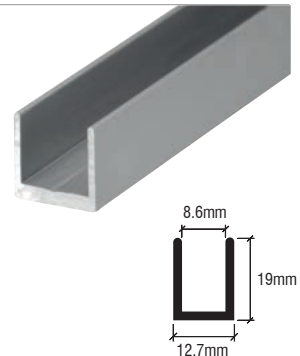

## CRL Aluminium U-Channel for 10mm Glass

- Wet glazed with clear silicone to secure glass
- Available in 2.49 m and 3.65 m stock lengths
- Available in up to 17 finishes - see [crlaurence.co.uk](http://crlaurence.co.uk)

~~WAS £9.88~~  
**NOW FROM ONLY**  
**£8.89\***  
**EACH**

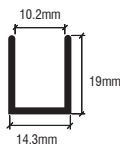
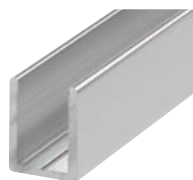

SDCD38

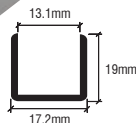
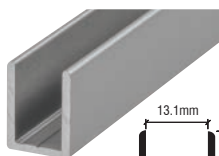

SDCD12

Cat. No.	Finish	Length	Depth	1	10	40	80	120
<b>SDCD38BA</b>	Bright Anodised	2.49 m	19 mm	£11.66	£10.98	£9.88	£9.38	£9.08
<b>SDCD38BN</b>	Brushed Nickel	2.49 m	19 mm	£12.51	£9.88	£9.38	£9.14	£8.89
<b>SDCD38MBL</b>	Matte Black	2.49 m	19 mm	£24.48	£21.75	£19.58	£17.80	£16.32
<b>SDCD3812BA</b>	Bright Anodised	3.65 m	19 mm	£20.41	£18.38	£16.68	£15.35	£14.11
<b>SDCD3812BN</b>	Brushed Nickel	3.65 m	9.5 mm	£21.16	£18.77	£17.28	£15.84	£14.54
<b>SDCD3812MBL</b>	Matte Black	3.65 m	9.5 mm	£35.86	£29.88	£26.89	£24.45	£21.52
<b>SDCD12BA</b>	Bright Anodised	2.49 m	19 mm	£12.66	£11.13	£10.21	£9.67	£9.18
<b>SDCD12BN</b>	Brushed Nickel	2.49 m	19 mm	£13.30	£12.08	£11.07	£10.23	£9.49
<b>SDCD12MBL</b>	Matte Black	2.49 m	19 mm	£25.61	£21.57	£18.61	£16.39	£14.64

\*Minimum order: 1 each. Price based on an order quantity of 120 (SDCD38BN).

## CRL Dry Glaze U-Channel With Vinyl for 8 and 10mm Glass

- Clear vinyls secure glass in channel and eliminate the need for messy silicone
- Recess in bottom channel hides caulk line
- DUC38 can be used with 8 mm glass where RV8DUC rigid vinyl is used (available separately)
- Individually packaged
- 2.49 m length

~~WAS £19.19~~  
**NOW FROM ONLY**  
**£14.49\***  
**EACH**

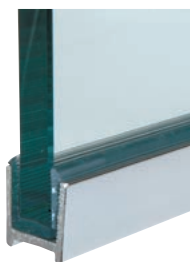

NOTE: glass is not included

Cat. No.	Finish	1	10	50
<b>DUC516BA</b>	Bright Anodised	£20.42	£17.52	£14.49
<b>DUC516BN</b>	Brushed Nickel	£22.71	£20.52	£18.74
<b>DUC38BA</b>	Bright Anodised	£18.56	£17.54	£16.59
<b>DUC38BN</b>	Brushed Nickel	£21.13	£20.25	£18.72

\*Minimum order: 1 each. Price based on an order quantity of 50 (DUC516BA).

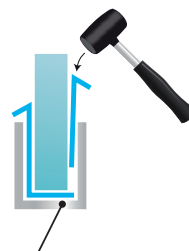
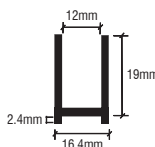

Complete by securing U-Channel

### CRL Clear 'Y' Jamb Seal With Soft Leg

- Soft vinyl single leg for quieter door closure
- Snaps onto fixed panel
- For 180° inline glass-to-glass applications
- Suggested gap: 4.7 mm
- 2.49 m stock length

~~WAS £8.95~~  
**NOW FROM ONLY**  
**£6.39\***  
 EACH

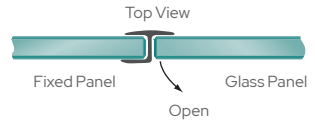
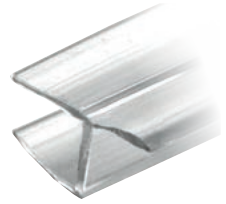
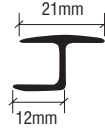

Cat. No.	Glass Thickness	1	10	40
<b>PCC10</b>	10 mm	£8.12	£7.13	£6.39

\*Minimum order: 1 each. Price based on an order quantity of 40.

### CRL Clear Vinyl Bulb Seal

- Can be used on inswing and outswing doors
- Suggested gap: 6 to 8 mm
- 2.49 m stock length

~~WAS £6.61~~  
**NOW FROM ONLY**  
**£6.33\***  
 EACH

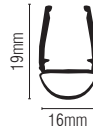

Cat. No.	Glass Thickness	1	10	40
<b>PCR10</b>	10 mm	£7.42	£6.70	£6.33

\*Minimum order: 1 each. Price based on an order quantity of 40.

### CRL Clear Co-Extruded Bottom Wipe With Drip Rail

- Snaps on bottom of door
- 45° drip rail assists in deflecting water back into the enclosure
- Suggested gap: 11 mm
- 2.49 m stock length

~~WAS £5.67~~  
**NOW FROM ONLY**  
**£5.29\***  
 EACH

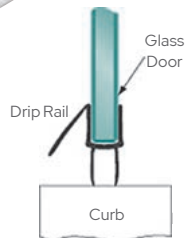
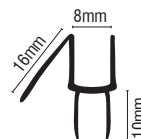

Cat. No.	Glass Thickness	1	10	40
<b>P990WS</b>	10 mm	£6.37	£5.77	£5.29

\*Minimum order: 1 each. Price based on an order quantity of 40.

## CRL Geneva Series Shower Hinges

- For 8 to 12 mm toughened safety glass
- Our most popular hinge series
- Square corner hinge design
- Self-centering when within 15° of closed position
- Construction: solid brass



GEN037

GEN044

GEN180

Cat. No.	Description	Finish	1	16
<b>GEN037CH</b>	Wall Mount Full Back Plate Hinge	Chrome	£24.41	£22.99
<b>GEN037BN</b>	Wall Mount Full Back Plate Hinge	Brushed Nickel	£24.41	£22.99
<b>GEN037MBL</b>	Wall Mount Full Back Plate Hinge	Matte Black	£34.53	£31.02
<b>GEN044CH</b>	Wall Mount Offset Back Plate Hinge	Chrome	£24.78	£22.98
<b>GEN044BN</b>	Wall Mount Offset Back Plate Hinge	Brushed Nickel	£24.78	£22.98
<b>GEN044MBL</b>	Wall Mount Offset Back Plate Hinge	Matte Black	£33.63	£31.85
<b>GEN180CH</b>	180 Degree Glass-to-Glass Hinge	Chrome	£33.49	£31.78
<b>GEN180BN</b>	180 Degree Glass-to-Glass Hinge	Brushed Nickel	£33.49	£31.78
<b>GEN180MBL</b>	180 Degree Glass-to-Glass Hinge	Matte Black	£40.92	£38.12

\*Minimum order: 1 each. Price based on an order quantity of 16 (GEN044CH).

Maximum Capacities	8 mm to 12 mm glass	
	Weight	Door Width
Using Two Hinges	36 kg	711 mm
Using Three Hinges	54 kg	813 mm

~~WAS £26.09~~  
**NOW FROM ONLY**  
**£22.98\***  
**EACH**

NOTE: Do not exceed maximum door weight or width when choosing proper quantity of hinges.

## CRL Geneva Clamps

- For 8 to 12 mm toughened safety glass
- Clamps match configuration of our popular Geneva hinge plus many more
- Square corner clamp design
- Construction: solid brass



GE90S

GE090

~~WAS £30.68~~  
**NOW FROM ONLY**  
**£27.33\***  
**EACH**

Cat. No.	Description	Finish	1	10	50
<b>GE90SCH</b>	Wall Mount Geneva Glass Clamp	Chrome	£31.43	£29.23	£27.33
<b>GE90SBN</b>	Wall Mount Geneva Glass Clamp	Brushed Nickel	£32.94	£30.08	£28.83
<b>GE090CH</b>	90° Glass-to-Glass Geneva Clamp	Matte Black	£37.92	£34.40	£33.60
<b>GE090BN</b>	90° Glass-to-Glass Geneva Clamp	Brushed Nickel	£40.01	£37.19	£34.76

\*Minimum order: 1 each. Price based on an order quantity of 50 (GE90SCH).

## CRL Pinnacle Series Shower Hinges

- For 8 to 12 mm toughened safety glass
- Bevelled edge hinge design
- Self-centering when within 15° of closed position
- Suggested gap: 4.7 mm
- 2.49 m stock length
- Construction: solid brass

WAS ~~£28.57~~  
 NOW FROM ONLY  
**£25.11\***  
 EACH



PIN037

Maximum Capacities	8 mm and 12 mm glass	
	Weight	Door Width
Using Two Hinges	36 kg	711 mm
Using Three Hinges	54 kg	813 mm

NOTE: Do not exceed maximum door weight or width when choosing proper quantity of hinges.

Cat. No.	Description	Finish	1	16
<b>PIN037CH</b>	Wall Mount Full Back Plate Hinge	Chrome	£26.45	£25.11
<b>PIN037BN</b>	Wall Mount Full Back Plate Hinge	Brushed Nickel	£27.81	£25.87
<b>PIN037MBL</b>	Wall Mount Full Back Plate Hinge	Matte Black	£30.93	£28.55
<b>PIN044CH</b>	Wall Mount Offset Back Plate Hinge	Chrome	£26.45	£25.11
<b>PIN044BN</b>	Wall Mount Offset Back Plate Hinge	Brushed Nickel	£27.81	£25.87
<b>PIN044MBL</b>	Wall Mount Offset Back Plate Hinge	Matte Black	£30.93	£28.55
<b>PIN180CH</b>	180 Degree Glass-to-Glass Hinge	Chrome	£40.24	£36.98
<b>PIN180BN</b>	180 Degree Glass-to-Glass Hinge	Brushed Nickel	£38.47	£36.64
<b>PIN180MBL</b>	180 Degree Glass-to-Glass Hinge	Matte Black	£52.17	£47.28

\*Minimum order: 1 each. Price based on an order quantity of 16 (PIN037CH).



PIN044



PIN180

## CRL Pinnacle Clamps

- For 8 to 12 m toughened safety glass
- Clamps match configuration of our popular Pinnacle hinge plus many more
- Bevelled corner clamp design
- Construction: solid brass

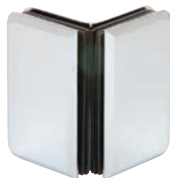

P1090



P190S

Cat. No.	Description	Finish	1	10	50
<b>P190SCH</b>	Wall Mount Pinnacle Glass Clamp	Chrome	£35.46	£32.93	£30.74
<b>P190SBN</b>	Wall Mount Pinnacle Glass Clamp	Brushed Nickel	£35.46	£32.93	£30.74
<b>P1090CH</b>	90° Glass-to-Glass Pinnacle Clamp	Chrome	£42.58	£39.53	£36.91
<b>P1090BN</b>	90° Glass-to-Glass Pinnacle Clamp	Brushed Nickel	£42.58	£39.53	£36.91

\*Minimum order: 1 each. Price based on an order quantity of 50 (P190SCH).

WAS ~~£33.85~~  
 NOW FROM ONLY  
**£30.74\***  
 EACH



## CRL Altea Series Shower Hinges

- For 6 to 10 mm toughened safety glass
- Cover plates hide fixing screws for a sleek, modern appearance
- Square corner hinge design
- Self closes from approximately 60°
- Construction: solid brass

~~WAS £18.76~~  
**NOW FROM ONLY**  
**£18.38\***  
**EACH**



Maximum Capacities	6 mm to 10 mm glass	
	Weight	Door Width
Using Two Hinges	36 kg	710 mm
Using Three Hinges	54 kg	810 mm

NOTE: Do not exceed maximum door weight or width when choosing proper quantity of hinges.

Cat. No.	Description	Finish	1	10	50
<b>ALTO37CH</b>	Wall Mount Full Back Plate Hinge	Chrome	£22.21	£19.01	£18.38
<b>ALTO37MBL</b>	Wall Mount Full Back Plate Hinge	Matte Black	£29.29	£26.63	£23.43
<b>ALTI80CH</b>	180 Degree Glass-to-Glass Hinge	Chrome	£29.41	£25.38	£23.97
<b>ALTI80MBL</b>	180 Degree Glass-to-Glass Hinge	Matte Black	£34.14	£28.45	£26.48

\*Minimum order: 1 each. Price based on an order quantity of 50 (ALTO37CH).

## CRL Altea Clamps

- For 6 to 10 mm toughened safety glass
- Clamps match configuration of Altea hinges
- Square corner clamp design
- Cover plates hides fixing screws for a sleek modern appearance
- Easy to install



Cat. No.	Description	Finish	1	10	50
<b>ALTC90CH</b>	90° Glass-to-Wall Clamp	Chrome	£13.54	£11.67	£11.09
<b>ALTC90MBL</b>	90° Glass-to-Wall Clamp	Brushed Nickel	£15.52	£14.11	£13.01
<b>ALTC380CH</b>	Adjustable Glass-to-Glass Clamp	Chrome	£17.71	£16.04	£15.12
<b>ALTC380MBL</b>	Adjustable Glass-to-Glass Clamp	Brushed Nickel	£21.33	£19.32	£18.28

\*Minimum order: 1 each. Price based on an order quantity of 50 (ALTC90CH).

**FROM ONLY**  
**£11.09\***  
**EACH**

### CRL Shower Door Knob

- For 6 to 12 mm toughened safety glass
- Attractive ribbed appearance
- 12 mm diameter hole required

~~WAS £12.58~~  
**NOW FROM ONLY**  
**£11.29\*** EACH

Cat. No.	Description	Finish	1	10	50
<b>SDK160CH</b>	Back-to-Back Square Style Knob	Chrome	£17.18	£15.29	£13.76
<b>SDK160BN</b>	Back-to-Back Square Style Knob	Brushed Nickel	£17.18	£15.29	£13.76
<b>SDK160MBL</b>	Back-to-Back Square Style Knob	Matte Black	£20.21	£19.20	£17.07
<b>SDK106CH</b>	Back-to-Back Contemporary Style Knob	Chrome	£12.95	£12.23	£11.29
<b>SDK106BN</b>	Back-to-Back Contemporary Style Knob	Brushed Nickel	£14.41	£13.20	£12.20
<b>SDK106MBL</b>	Back-to-Back Contemporary Style Knob	Matte Black	£14.86	£14.49	£13.38

\*Minimum order: 1 each. Price based on an order quantity of 50 (SDK106CH).



SDK160



SDK106

### CRL Back-To-Back Paddle Knob

- For 6 to 12 mm toughened safety glass
- Flat 'paddle' shape appearance with square corners
- Two 12 mm diameter holes required

~~WAS £32.34~~  
**NOW FROM ONLY**  
**£28.55\*** EACH

Cat. No.	Description	Finish	1	10	50
<b>SDK180CH</b>	Back-to-Back Paddle Style	Chrome	£33.81	£30.60	£28.55
<b>SDK180BN</b>	Back-to-Back Paddle Style	Brushed Nickel	£42.86	£39.20	£34.76
<b>SDK180MBL</b>	Back-to-Back Paddle Style	Matte Black	£42.67	£37.47	£34.93

\*Minimum order: 1 each. Price based on an order quantity of 50 (SDK180CH).



### CRL Ladder Style Back-To-Back Pull Handle

- For 8 to 12 mm toughened safety glass
- Mounting holes 152 and 203 mm centre-to-centre
- Two 12 mm diameter hole required

~~WAS £50.89~~  
**NOW FROM ONLY**  
**£48.53\*** EACH

Cat. No.	Description	Finish	1	10	50
<b>LP6X6CH</b>	152 mm Handle	Chrome	£53.92	£51.10	£48.53
<b>LP6X6BN</b>	152 mm Handle	Brushed Nickel	£53.92	£51.10	£48.53
<b>LP6X6MBL</b>	152 mm Handle	Matte Black	£58.97	£54.11	£50.69
<b>LP8X8CH</b>	203 mm Handle	Chrome	£60.30	£56.45	£53.07
<b>LP8X8BN</b>	203 mm Handle	Brushed Nickel	£60.30	£56.45	£53.07
<b>LP8X8MBL</b>	203 mm Handle	Matte Black	£64.28	£59.43	£56.25

\*Minimum order: 1 each. Price based on an order quantity of 50 (LP6X6CH).



LP6X6MBL

LP8X8MBL

### CRL BM Series Back-To-Back Pull Handle

- For 6 to 12 mm toughened safety glass
- Mounting holes 152 and 203 mm centre-to-centre
- With metal washers
- Two 12 mm diameter holes required

~~WAS £15.85~~  
**NOW FROM ONLY**  
**£14.27\*** EACH

Cat. No.	Description	Finish	1	10	50
<b>BM6X6CH</b>	152 mm Handle	Chrome	£17.43	£15.70	£14.27
<b>BM6X6BN</b>	152 mm Handle	Brushed Nickel	£17.43	£15.70	£14.27
<b>BM6X6MBL</b>	152 mm Handle	Matte Black	£17.63	£16.10	£14.41
<b>BM8X8CH</b>	203 mm Handle	Chrome	£19.65	£17.59	£16.08
<b>BM8X8BN</b>	203 mm Handle	Brushed Nickel	£19.65	£17.59	£16.08
<b>BM8X8MBL</b>	203 mm Handle	Matte Black	£19.91	£18.07	£16.79

\*Minimum order: 1 each. Price based on an order quantity of 50 (BM6X6CH).

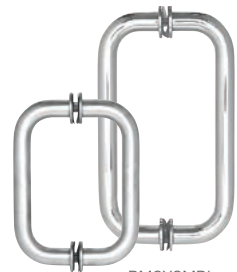

BM6X6MBL

BM8X8MBL

## CRL TPC Surface Protector

- Transparent polymer coating
- Water, soil and stain repellent
- Protects glass and many other surfaces
- Clear coating guards against the adhesion and build-up of dirt, grime, mould, mildew, rust and mineral deposits
- Suitable for clear and sandblasted glass surfaces

~~WAS £8.65~~  
**NOW FROM ONLY**  
**£8.46\***  
 EACH



Cat. No.	Description	1	12
<b>TPC16</b>	473 ml bottle	£8.87	£8.46
<b>TPC5GL</b>	18.9 Litre tub	£232.79	-

\*Minimum order: 1 each. Price based on an order quantity of 12 (TPC16).

## CRL Superior Squeegee With Chrome Cap

- Wipes water spots from glass, tile and marble surfaces
- 254 mm blade in a 203 mm handle

~~WAS £15.06~~  
**NOW FROM ONLY**  
**£11.41\***  
 EACH



Cat. No.	Colour	1	12
<b>SQWC1</b>	White	£13.31	£11.41
<b>SQBC1</b>	Black	£13.31	£11.41

\*Minimum order: 1 each. Price based on an order quantity of 12.

## CRL Chrome Deluxe Shower Squeegee

- Chrome handle with 254 mm wide grey blade
- Includes vacuum cup hook that requires no drilling

~~WAS £19.81~~  
**NOW ONLY**  
**£17.09\***  
 EACH



Cat. No.	Description	1
<b>17600</b>	Chrome Deluxe Shower Squeegee	£17.09

\* Minimum order: 1 each. Price based on an order quantity of 1.

# CRL Hydroslide Series Sliding Shower Door System

- Excellent design for compact areas
- Quick and easy installation
- Clean, sleek lines
- Available in four stock finishes, custom finishes available
- Custom units available by special order
- Glass fabrication required
- For use with 8 mm to 10 mm monolithic toughened glass

## Standard 180 Degree Kit Includes:

- 1 - Sliding glass door upper track
- 2 - Hangers for sliding glass door
- 2 - Sliding glass door rollers
- 2 - Sliding glass door roller stops
- 1 - Sliding glass door floor guide
- 2 - 90 degree wall-to-upper track connectors
- 2 - 180 degree glass-to-sliding track connectors
- 1 - 914 mm half-round SDT980 threshold
- 1 - 2489 mm DK98L L-seal for wall



Image shown here:  
HYDA9

**NOTE:** Bottom fixed glass attachments, handles or knobs must be ordered separately.

## 90 Degree\*\* Wall-to-Glass Accessory Kit Includes:

- 1 - 90 degree glass-to-sliding track connector
- 1 - 90 degree wall-to-glass bracket

\*\*90 degree units require that you order one 180 degree Standard Kit plus one 90 degree Accessory Kit



WAS £211.23  
NOW FROM ONLY  
**£186.43\***

Maximum Capacities	8 mm to 10 mm	
	Weight	Door Width
HYDK60	40 kg	1520 mm
HYDK84	40 kg	2130 mm

**NOTE:** Do not exceed maximum door weight or width.



Cat. No.	Description	Finish	1	6
HYDK60CH	Standard 180 degree kit 1524 mm	Bright Anodised / Chrome	£201.88	£186.43
HYDK60BN	Standard 180 degree kit 1524 mm	Brushed Nickel	£224.54	£211.15
HYDK84CH	Standard 180 degree kit 2134 mm	Bright Anodised / Chrome	£218.36	£202.91
HYDK84BN	Standard 180 degree kit 2134 mm	Brushed Nickel	£239.99	£225.57
HYDA9CH	90 degree wall-to-glass accessory kit	Bright Anodised / Chrome	£55.53	£52.31
HYDA9BN	90 degree wall-to-glass accessory kit	Brushed Nickel	£64.92	£61.18

\*Minimum order: 1 each. Price based on an order quantity of 6 (HYDK60CH).

# CRL Deluxe Serenity Series Sliding Shower Door System

- Unique 180° system with rollers above and below the header bar
- System features one sliding door and one fixed panel
- Fixed and sliding glass panels are reversible for installation (glass not included)
- Use of minimal hardware gives door an almost floating appearance
- Glass fabrication required
- Accessory kit available for 90° return panels (SER90XX)
- For use with 8 to 10 mm monolithic toughened glass

## Deluxe 180 Degree Kit Includes:

- 1 - 2 m length header support bar
- 4 - Rollers
- 1 - Stopper
- 2 - Track holder fittings for wall
- 2 - Track holder fittings for fixed panel
- 1 - Thru-glass pull
- 1 - Door guide
- 1 - 2.16 m length clear L-jamb



Image shown here:  
SER90BS



	8 mm to 10 mm	
	Weight	Door Width
<b>Maximum Capacities</b>	40 kg	762 mm



Cat. No.	Description	Finish	1	6
<b>SER78BS</b>	Deluxe 180 Degree Kit	Brushed Stainless	£250.29	£224.54
<b>SER78PS</b>	Deluxe 180 Degree Kit	Polished Stainless	£264.71	£245.14
<b>SER78MBL</b>	Deluxe 180 Degree Kit	Matte Black	£269.86	£249.26
<b>SER90BS</b>	90 Degree Accessory Kit	Brushed Stainless	£7.55	£6.97
<b>SER90PS</b>	90 Degree Accessory Kit	Polished Stainless	£8.21	£7.81
<b>SER90MBL</b>	90 Degree Accessory Kit	Matte Black	£10.08	£9.03
<b>SERAHW2BS</b>	Track Holder Fittings for Wall	Brushed Stainless	£21.69	£19.77
<b>SERAHW2PS</b>	Track Holder Fittings for Wall	Polished Stainless	£27.52	£23.06
<b>SERAHW2MBL</b>	Track Holder Fittings for Wall	Matte Black	£28.59	£25.53

\*Minimum order: 1 each. Price based on an order quantity of 6 (SER78BS).



# CRL Door Controls



## CRL Floor Spring and Patch Fitting Set

- Floor Spring and Patch Fitting Set includes:
  - 1 x Bottom Door Patch Insert (INT301)
  - 1 x Top Door Patch Insert (INT303)
  - 1 x Top Free Swinging Pivot (INT401)
  - 1 x 180D Adjustable Closer/90D HO Floor Mount (EUCRL8460V)
  - 1 x PS Ladder Pull 600 mm L 32 mm D (EULP60032BS)
  - 1 x Brushed Stainless Steel Euro Top/bottom Door Patch (EUR201BS)
- For use with 10 to 12 mm monolithic toughened glass
- Max door weight: 100 kg
- Max door width: 1100 mm
- Quick installation - no hole required in the floor
- Glass fabrication required



INT301



INT303

EULP60032



INT401



EUCRL8460V



EUR201

~~WAS £153.15~~  
**NOW FROM ONLY**  
**£142.12\***  
**EACH**

Cat. No.	Description	Finish	1
<b>CRL8460BSSET</b>	Floor Spring and Patch Fitting Set	Brushed Stainless	£142.12
<b>CRL8460PSSET</b>	Floor Spring and Patch Fitting Set	Polished Stainless	£146.14

\*Minimum order: 1 each. Price based on an order quantity of 1 (CRL8460BSSET).

## CRL Hydraulic Patch Fittings With Backcheck

- Kit includes 1x hydraulic patch fitting with back check (CRL380), 1x top door patch fitting (PH21ABS) and 1x centre-hung free swinging top pivot (INT401)
- For use with 10 to 12 mm monolithic toughened glass
- Max door weight: 100 kg
- Max door width: 1100 mm
- Adjustable closing speed from 110° to 20° and from 20° to 0°
- Quick installation - no hole required in the floor
- Glass fabrication required



CRL380



PH21ABS



INT401

Cat. No.	Description	Finish	1	6
<b>CRL380BSSET</b>	Kit with no hold open	Brushed Stainless	£122.42	£110.19
<b>CRL380PSSET</b>	Kit with no hold open	Polished Stainless	£122.64	£110.38
<b>CRL380HBSSET</b>	Kit with hold open	Brushed Stainless	£127.98	£115.19
<b>CRL380HPSSET</b>	Kit with hold open	Polished Stainless	£128.21	£115.39

\*Minimum order: 1 each. Price based on an order quantity of 6 (CRL380BSSET).

~~WAS £122.57~~  
**NOW FROM ONLY**  
**£110.19\***  
**EACH**



## CRL Oil Dynamic Wall-to-Glass Hinge

- Adjustable closing speed
- Swings in and out a full 90 degrees, with stops at 0°, +90°, and -90°
- Also available in no-hold open option
- For use with 8 to 13.52 mm toughened glass
- 100 kg max door weight
- 1000 mm max door width
- No hold open option also available on all models



~~WAS £113.70~~  
**NOW FROM ONLY**  
**£109.51\***  
 EACH



Cat. No.	Description	Finish	1	6
<b>H8010CH</b>	Wall-to-Glass Hinge	Chrome	£114.51	£109.51
<b>H8010SN</b>	Wall-to-Glass Hinge	Satin Nickel	£123.27	£117.41
<b>H8015CH</b>	Glass-to-Glass Hinge	Chrome	£154.21	£146.61
<b>H8015SN</b>	Glass-to-Glass Hinge	Satin Nickel	£170.57	£158.29

\*Minimum order: 1 each. Price based on an order quantity of 6 (H8010CH).

## CRL Ladder Pull Handle

- Ladder style pull handles for back-to-back mounting
- Through-bolts supplied
- For use with 8 to 19 mm glass
- 12 mm diameter holes required
- Sold as a pair



~~WAS £31.33~~  
**NOW FROM ONLY**  
**£26.81\***  
 EACH

Cat. No.	Length	Centre-To-Centre	Finish	1	5
<b>EULP40019BS</b>	300 mm	200 mm	Brushed Stainless	£35.05	£26.81
<b>EULP40019PS</b>	300 mm	200 mm	Polished Stainless	£36.39	£27.82
<b>EULP60032BS</b>	600 mm	450 mm	Brushed Stainless	£44.41	£33.95
<b>EULP60032PS</b>	600 mm	450 mm	Polished Stainless	£46.41	£35.38
<b>EULP100032BS</b>	1,000 mm	800 mm	Brushed Stainless	£73.11	£55.91
<b>EULP100032PS</b>	1,000 mm	800 mm	Polished Stainless	£76.78	£58.71

\*Minimum order: 1 pair. Price based on an order quantity of 5 pairs (EULP40019BS).



## CRL Aluminium Glazing Profiles

### CRL Wet/Dry Glaze U-Channel

- Typically used at the bottom of glass panels
- Use with silicone (wet) or glazing gasket (dry) for 10 and 12 mm toughened glass
- 3 m stock lengths
- Also available in 6 m stock lengths

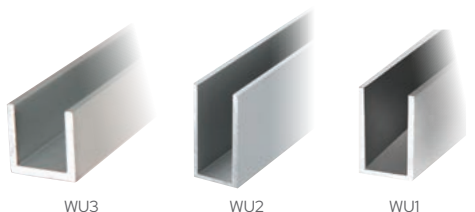

WU3

WU2

WU1

Cat. No.	Depth	Finish	1	10
WU3SASL	25.4 mm	Satin Anodised	£26.88	£23.72
WU3BSASL	25.4 mm	Brushed Stainless Anodised	£39.77	£34.74
WU3BASL	25.4 mm	Bright Anodised	£40.51	£36.45
WU1SASL	38 mm	Satin Anodised	£33.37	£30.11
WU1BSASL	38 mm	Brushed Stainless Anodised	£53.04	£46.19
WU1BASL	38 mm	Bright Anodised	£47.52	£43.56
WU2SASL	51 mm	Satin Anodised	£45.77	£41.31
WU2BSASL	51 mm	Brushed Stainless Anodised	£61.06	£54.75
WU2BASL	51 mm	Bright Anodised	£61.51	£60.72

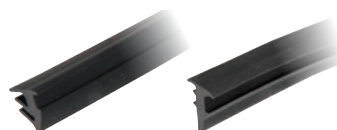

To secure 10 mm glass, order gasket RG38100

To secure 12 mm glass, order gasket RG12100

\*Minimum order: 1 stock length. Price based on an order quantity of 10 stock lengths (WU3SASL). Packing charge added to orders of fewer than 5 assorted lengths of any U-channels.

Cat. No.	Description	1	6
RG38100	Gasket - Used with 10 mm glass	£24.67	£23.03
RG12100	Gasket - Used with 12 mm glass	£18.91	£17.39

~~WAS £28.14~~  
**NOW FROM ONLY**  
**£23.72\***  
**EACH**



### CRL Clear Glass Joint System 180° Partition Strip

- Provides a clear slimline finish between two glass panels
- Excellent adhesion from pre-applied high bond tape
- 3 m lengths

~~WAS £6.95~~  
NOW FROM ONLY  
**£6.28\***  
EACH

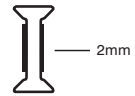

Cat. No.	Glass Thickness	Glass Type	1	25	50
EZCC10	10 mm	Toughened	£7.41	£6.91	£6.34
EZCC108	10.8 mm	Laminated	£7.33	£6.84	£6.28
EZCC12	12 mm	Toughened	£7.52	£7.01	£6.54
EZCC128	12.8 mm	Laminated	£7.58	£7.06	£6.62

\*Minimum order: 1 each. Price based on an order quantity of 50 (EZCC108).

### CRL Clear Glass Joint System 90° Corner Protection Strip

- Provides a clear slimline finish between two glass panels
- Excellent adhesion from pre-applied high bond tape
- 3 m lengths

~~WAS £7.56~~  
NOW FROM ONLY  
**£6.72\***  
EACH

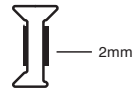

Cat. No.	Glass Thickness	Glass Type	1	25	50
EZCL10	10 mm	Toughened	£8.01	£7.41	£6.72
EZCL108	10.8 mm	Laminated	£8.11	£7.33	£6.84
EZCL12	12 mm	Toughened	£8.38	£7.55	£6.86
EZCL128	12.8 mm	Laminated	£8.36	£7.57	£7.06

\*Minimum order: 1 each. Price based on an order quantity of 50 (EZCL10).

### CRL Clear Glass Joint System 3-Way Partition Strip

- Provides a clear slimline finish between two glass panels
- Excellent adhesion from pre-applied high bond tape
- 3 m lengths

~~WAS £11.26~~  
NOW FROM ONLY  
**£10.21\***  
EACH

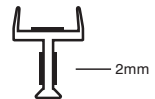

Cat. No.	Glass Thickness	Glass Type	1	25	50
EZCT10	10 mm	Toughened	£12.07	£10.46	£10.29
EZCT108	10.8 mm	Laminated	£12.31	£10.91	£10.21
EZCT12	12 mm	Toughened	£12.46	£11.31	£10.34
EZCT128	12.8 mm	Laminated	£12.42	£11.29	£10.31

\*Minimum order: 1 each. Price based on an order quantity of 50 (EZCT108).

### CRL Clear Glass Joint System Abutment Strip

- Provides a clear slimline finish between two glass panels
- Excellent adhesion from pre-applied high bond tape
- 3 m lengths

~~WAS £7.88~~  
NOW FROM ONLY  
**£7.11\***  
EACH

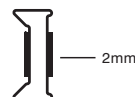

Cat. No.	Glass Thickness	Glass Type	1	25	50
EZCE10	10 mm	Toughened	£8.78	£8.14	£7.11
EZCE108	10.8 mm	Laminated	£8.71	£8.09	£7.23
EZCE12	12 mm	Toughened	£9.01	£8.31	£7.36
EZCE128	12.8 mm	Laminated	£8.89	£8.24	£7.34

\*Minimum order: 1 each. Price based on an order quantity of 50 (EZCE10).

## CRL Clear Glass Joint System 180° In-Line 2-Way Partition Strip

- Clips over the glass joint
- Does not feature clear high bond tape
- 3 m lengths

~~WAS £5.74~~  
NOW FROM ONLY  
**£5.26\***  
EACH



Cat. No.	Glass Thickness	Glass Type	1	25	50
<b>CLON10</b>	10 mm	Toughened	£6.14	£5.61	£5.26
<b>CLON108</b>	10.8 mm	Laminated	£6.38	£5.65	£5.31
<b>CLON12</b>	12 mm	Toughened	£6.68	£6.37	£5.82
<b>CLON128</b>	12.8 mm	Laminated	£6.75	£6.44	£5.89

\*Minimum order: 1 each. Price based on an order quantity of 50 (CLON10).



## CRL Clear Glass Joint System 90° 2-Way Partition Strip

- Clips over the glass joint
- Excellent adhesion from pre-applied clear high bond tape
- 3 m lengths

~~WAS £8.28~~  
NOW FROM ONLY  
**£7.54\***  
EACH



Cat. No.	Glass Thickness	Glass Type	1	25	50
<b>CLON210</b>	10 mm	Toughened	£8.91	£8.09	£7.57
<b>CLON2108</b>	10.8 mm	Laminated	£8.82	£8.22	£7.54
<b>CLON212</b>	12 mm	Toughened	£9.62	£8.75	£8.02
<b>CLON2128</b>	12.8 mm	Laminated	£9.53	£8.88	£8.14

\*Minimum order: 1 each. Price based on an order quantity of 50 (CLON2108).

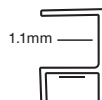

## CRL Clear Glass Joint System 90° 3-Way Partition Strip

- Clips over the glass joint
- Excellent adhesion from pre-applied clear high bond tape
- 3 m lengths

~~WAS £8.16~~  
NOW FROM ONLY  
**£7.41\***  
EACH

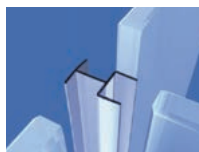

Cat. No.	Glass Thickness	Glass Type	1	25	50
<b>CLON310</b>	10 mm	Toughened	£8.71	£7.91	£7.41
<b>CLON3108</b>	10.8 mm	Laminated	£8.63	£8.04	£7.53
<b>CLON312</b>	12 mm	Toughened	£9.42	£8.56	£8.02
<b>CLON3128</b>	12.8 mm	Laminated	£9.34	£8.71	£8.14

\*Minimum order: 1 each. Price based on an order quantity of 50 (CLON310).

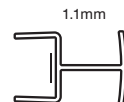

## CRL Clear Glass Joint System 135° 2-Way Partition Strip

- Clips over the glass joint
- Excellent adhesion from pre-applied clear high bond tape
- 3 m lengths

~~WAS £11.36~~  
NOW FROM ONLY  
**£10.36\***  
EACH



Cat. No.	Glass Thickness	Glass Type	1	25	50
<b>CLON410</b>	10 mm	Toughened	£12.17	£11.06	£10.36
<b>CLON4108</b>	10.8 mm	Laminated	£12.02	£11.21	£10.48
<b>CLON412</b>	12 mm	Toughened	£13.15	£11.95	£11.19
<b>CLON4128</b>	12.8 mm	Laminated	£12.97	£12.09	£11.31

\*Minimum order: 1 each. Price based on an order quantity of 50 (CLON410).

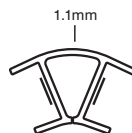

## CRL Wood's Powr-Grip® Vacuum Cup

- 203 mm diameter pad
- Check valve allows re-pumping without loss of remaining vacuum
- Release valve lever permits quick and complete release
- Fast attachment on smooth, non-porous flat surfaces
- Red-line indicator warns user of any vacuum loss
- Supplied with protective carrying case
- 57 kg lifting capacity



Cat. No.	Description	1	5	10
N4000	ABS Handle Vacuum Cup	£38.10	£34.63	£31.75
N4950	Metal Handle Vacuum Cup	£58.97	-	-

\*Minimum order: 1 each. Price based on an order quantity of 10 (N4000).



WAS £35.28  
NOW FROM ONLY  
**£31.75\***  
EACH

## CRL Aluminium Frame Vacuum Lifters

- Sturdily built traditional design plastic and aluminium frame
- Each suction pad operates separately
- 114 mm diameter suction pads

WAS £34.36

NOW FROM ONLY

**£30.13\***

EACH

Cat. No.	Description	1	6
05062	2 Vacuum Pads - Aluminium	£35.23	£32.03
05062P	2 Vacuum Pads - Plastic	£33.11	£30.13
05063	3 Vacuum Pads - Aluminium	£41.05	£36.93
05063P	3 Vacuum Pads - Plastic	£46.04	£38.93

\*Minimum order: 1. Price based on an order quantity of 6 (05062P).



## CRL All Terrain Dolly

- Exclusive to CRL
- Terrific for moving heavy glass panels around the job site
- Goes where other glass dollies won't
- Frame in solid aluminium
- Built-In 203 mm Wood's Powr-Grip® Vacuum Cup
- Includes a set of our RB200 Roller Blocks
- 181 kg load capacity

WAS £550.10

NOW ONLY

**£399.64\***

EACH



Included

Cat. No.	Description	1
ATD1	All Terrain Dolly	£399.64

\*Minimum order: 1. Price based on an order quantity of 1.

## CRL Roller Blocks

- Roller design lets you rotate heavy glass panels with ease
- Turn them over to use as resting blocks
- Rubber base ensures traction

WAS £52.67

NOW ONLY

**£45.42\***

PER PAIR



Cat. No.	Description	1
RB200	Roller Blocks	£45.42

\*Minimum order: 1. Price based on an order quantity of 1.



## CRL Glasstrax Glass Dolly

- Self clamping action locks loads up to 50.8 mm thick
- One person can load and manoeuvre
- Safe glass transport with large 272 kg capacity

~~WAS £501.36~~

NOW ONLY

**£477.75\***

EACH



Cat. No.	Description	1
GT02	Glass Dolly	£477.75

\*Minimum order: 1. Price based on an order quantity of 1.

## CRL Corner Protectors

- Designed to protect glass and mirror edges during shipping, handling or storing
- Will not scratch or damage glass or mirror surfaces, and help protect large cut-offs from breakage or becoming scrap
- Protectors are reusable, they simply slide on and off
- 1,000 per box



PRICE PER BOX OF 1000

Cat. No.	Glass Thickness	1	10
1463004K	4 mm	£58.20	£52.27
1463006K	6 mm	£52.63	£47.48
1463008K	8 mm	£47.48	£42.75
1463010K	10 mm	£54.38	£48.93
1463012K	12 mm	£55.52	£49.96

\*Minimum order: 1 box. Price based on an order quantity of 10 boxes (1463008K).

~~WAS £64.77~~  
 NOW FROM ONLY  
**£42.75\***  
 PER BOX

## CRL Coloured Armoured Corner Protectors

- For five different glass thicknesses
- Sturdy, reusable corners absorb impact when glass is bumped or dropped
- A small investment can save expensive glass and help prevent costly accidents



Cat. No.	Glass Thickness	12	100
ACP14	6 mm	£1.23	£0.89
ACP16	8 mm	£1.23	£0.89
ACP38	10 mm	£1.23	£0.89
ACP12	12 mm	£1.23	£0.89
ACP58	16 mm	£1.23	£0.89

\*Minimum order: 12. Price based on an order quantity of 100.

~~WAS £0.96~~  
 NOW FROM ONLY  
**£0.89\***  
 EACH

## CRL Wood's Powr-Grip® Vacuum Lifting Frames

- Cord-free operation with on-board gel cell battery
- 280 mm diameter lipped pads
- Locks in place every quarter turn
- Three configurations all from the same unit
- Load movement: manual rotation 360° edgewise with automatic locking at each 1/4 revolution, assisted manual tilt 90° between upright and flat
- Dual vacuum system
- 12V DC
- 320 kg lifting capacity

See more details at [crlaurence.co.uk](http://crlaurence.co.uk)



EUMRTA811LDC3



EUMRTA811LDC3



EUMRT411LDC2

~~WAS £4,258.46~~  
**NOW FROM ONLY**  
**£3,765\***  
 EACH



Cat. No.	Description	Lifting Capacity	1
<b>EUMRT411LDC2</b>	D.C. Manual Rotator/Tilter - 4 pads	320 kg	£3,765.00
<b>EUMRTA811LDC3</b>	High-Flow D.C. Quadra Tilt Rotator - 8 pads	635 kg	£5,530.00

\* Minimum order: 1 each. Price based on an order quantity of 1 (EUMRT411LDC2).

## CRL Wood's Powr-Grip® Single Channel D.C. Vacuum Lifting Frame

- Four 280 mm diameter lipped pads
- 180° edgewise rotation
- 90° tilt, vertical to flat
- Automatic 'self-test' function ensures that the cups are safely loaded
- High holding strength and safe to use due to the dual-circuit suction system
- 12V DC
- 320 kg lifting capacity

See more details at [crlaurence.co.uk](http://crlaurence.co.uk)



~~WAS £3,275.80~~  
**NOW ONLY**  
**£2,845\***  
 EACH



Cat. No.	Description	1
<b>EUP11104DCO</b>	Single Channel D.C. Vacuum Lifting Frame	£2,845.00

\*Minimum order: 1 each. Price based on an order quantity of 1.



## CRL Atlas® Cut-Resistant Kevlar® Gloves

- Ergonomic fit as well as an outstanding grip
- The perfect glove for glass fabricators
- ANSI cut resistance: 3

~~WAS £10.24~~  
**NOW ONLY**  
**£8.83\***  
 PER PAIR



Cat. No.	Size	1
<b>300KVM</b>	Medium	£8.83
<b>300KVL</b>	Large	£8.83
<b>300KVXL</b>	Extra Large	£8.83

\*Minimum order: 1 pair. Price based on an order quantity of 1 pair.

## CRL Cut-Resistant Powerflex+ Kevlar® Gloves

- Excellent cut resistance and grip
- Protects against cuts, punctures, and slashes
- Cut Level 5
- Tested EN388 3444
- Sold by the pair

~~WAS £12.60~~  
**NOW FROM ONLY**  
**£12.01\***  
 PER PAIR



Cat. No.	Size	1	20
<b>0626</b>	Medium	£13.11	£12.01
<b>0627</b>	Large	£13.71	£12.60

\* Minimum order: 1 pair. Price based on an order quantity of 20 pairs.

## CRL Cut Resistant Level 5 Wrist Guards

- Our best value wrist guard
- Can be worn on either arm
- Loop and hook fastening
- Durable and comfortable
- BS EN 388 X-5-X-3
- Sold by the pair

~~WAS £13.57~~  
**NOW FROM ONLY**  
**£11.63\***  
 PER PAIR



Cat. No.	Length	1	12	24
<b>0601</b>	152 mm	£12.87	£12.01	£11.63
<b>0602</b>	203 mm	£16.11	£14.51	£13.18

\* Minimum order: 1 pair. Price based on an order quantity of 24 pairs (0601).

## CRL TOYO® Notch Wheel Supercutter®

- Achieve an ideal score with less pressure
- Excellent glass edge quality
- Longer wheel life
- Starting a score, notches "grip" the glass to eliminate slip
- Ideal for scoring large format glass
- Plastic handles
- Self-oiling cutter



**WAS £15.83**  
**NOW FROM ONLY**  
**£14.61\***  
**EACH**

Cat. No.	Description	1	6	12
<b>TC70P</b>	Patterned Head	£16.19	£15.77	£14.61
<b>TC70HP</b>	Replacement Cutting Head for TC70P	£11.53	£11.22	£9.66

\*Minimum order: 1 each. Price based on an order quantity of 12 (TC70P).

## CRL TOYO® Original Supercutter®

- Brass or plastic straight end handles
- 140 degree hone angle carbide wheels
- For cutting 4 to 8 mm glass



**WAS £16.55**  
**NOW FROM ONLY**  
**£15.38\***  
**EACH**

Cat. No.	Description	1	6	12
<b>TC17B</b>	Brass Handle	£18.37	£17.81	£16.22
<b>TC17P</b>	Plastic Handle	£18.36	£17.25	£15.38
<b>TC17H</b>	Replacement Cutting Head - Wide	£11.87	£10.91	£10.09

\*Minimum order: 1 each. Price based on an order quantity of 12 (TC17P).

## CRL Single Edge Razor Blades

- Our most popular single edge blade
- Precision honed, surgical steel edges
- Individually wrapped to protect the edge
- Multiple uses
- 100 per box

**WAS £3.38**  
**NOW FROM ONLY**  
**£3.08\***  
**EACH**



PRICE PER BOX OF 100 BLADES

Cat. No.	Description	1	2	5	50	100
<b>51S</b>	Single Edge Razor Blades	£3.88	£3.71	£3.55	£3.33	£3.08

\*Minimum order: 1 box. Price based on an order quantity of 100 boxes.

**Best Seller**

## CRL Razor Blade Holder and Scraper

- Safely holds single edge metal razor blades
- Comfortable handle for a sure grip
- Compatible with 51S and KKB12 razor blades

**WAS £6.95**  
**NOW FROM ONLY**  
**£5.62\***  
**EACH**



Cat. No.	Description	1
<b>RS65</b>	Razor Blade Holder and Scraper	£5.62

\*Minimum order: 1 each. Price based on an order quantity of 1.

## CRL Sealant Finishing Tool

- Lightweight and flexible, simplifies tooling of sealants
- Titanium catalyst material will not stick to silicone or other sealants
- 83 mm x 89 mm x 5 mm

~~WAS £2.84~~  
**NOW FROM ONLY**  
**£2.05\***  
 EACH



55BSS

Cat. No.	Description	1	6
<b>55BSS</b>	Sealant Finishing Tool	£2.56	£2.05

\*Minimum order: 1. Price based on an order quantity of 6.

## CRL Plastic Stick Tool

- A very popular tool with limitless uses
- Perfect for tooling freshly applied sealants, pushing vinyl into window channels, mixing paint and setting or removing glass from rubber gaskets
- Made of special high strength, flexible plastic
- CRL216 tapered on both ends
- CRL220 tapered and chisel end on one tool
- Stick handle available, CRL216H

~~WAS £0.53~~  
**NOW FROM ONLY**  
**£0.44\***  
 EACH



CRL216

CRL220

Cat. No.	Description	1	10	50	100
<b>CRL216</b>	Tapered End	£0.64	£0.56	£0.49	£0.44
<b>CRL220</b>	Chisel End	£0.69	£0.58	£0.51	£0.48

\*Minimum order: 1 each. Price based on an order quantity of 100 (CRL216).

**Multi-Usage**

## CRL Face Cap Remover

- For lifting and setting plate glass
- Helps prevent lifting related injuries
- Aids in storefront window installation
- Width: 273 mm

~~WAS £30.01~~  
**NOW FROM ONLY**  
**£25.59\***  
 EACH



Tailor made for curtain wall installers!

Cat. No.	Description	1	5	10
<b>FCR1</b>	Face Cap Remover	£31.99	£29.53	£25.59

\*Minimum order: 1 each. Price based on an order quantity of 10.

## CRL Nozzle Cutter

- Use on all plastic cartridges to cut nozzle tip and threaded tip then cut the nozzle tip to the desired opening size at the proper angle

~~WAS £15.69~~  
**NOW FROM ONLY**  
**£14.37\***  
 EACH



Cat. No.	Description	1	6
<b>NC594</b>	Nozzle Cutter	£15.48	£14.37

\*Minimum order: 1. Price based on an order quantity of 6.



## CRL Neutral Cure Construction Silicone

- Neutral cure, low modulus silicone
- Versatile sealant
- Cures under the influence of humidity to form a durable elastic rubber seal
- Specifically developed for durable elastic sealing of expansion joints in concrete, brickwork, curtain wall constructions, kitchens, bathrooms, showers, industrial applications and glazing systems
- UV, water, weather and mould resistant
- Available in clear, black and white
- 300 ml cartridge
- 12 per case

~~WAS £1.97~~  
**NOW FROM ONLY**  
**£1.84\***  
 EACH

Cat. No.	Colour	1	12	120	240
<b>CRLNCSC</b>	Clear	£2.32	£2.14	£1.99	£1.84
<b>CRLNCSBL</b>	Black	£2.32	£2.14	£1.99	£1.84
<b>CRLNCSSW</b>	White	£2.32	£2.14	£1.99	£1.84

\*Minimum order: 1 cartridge. Price based on an order quantity of 240 cartridges.





## CRL MS Polymer Mirror Fix

- High quality professional mirror and painted glass adhesive developed with MS Polymer hybrid technology
- Adheres without the use of primer to most non-porous substrates
- Free of isocyanates, solvents, silicones and plasticiser
- No shrinkage
- UV, water, weather and mould resistant
- Mirrors should be mechanically supported while the adhesive is curing
- Colour: White
- 290 ml cartridge
- 12 per case



WAS £2.04  
NOW FROM ONLY  
**£1.91\***  
EACH

Cat. No.	Colour	1	12	60	120
EGMSFIX	White	£2.39	£2.20	£2.04	£1.91

\*Minimum order: 1 cartridge. Price based on an order quantity of 120 cartridges.

## CRL EG310ULTRA Complete Adhesive

- MS Polymer based
- Neutral curing and odourless
- Cures with atmospheric moisture
- Super-fast bonding of mirrors, glass, wood, composite panels and metal to a range of substrates
- Free of silicone and isocyanides
- 290 ml cartridge
- 12 per case



WAS £5.24  
NOW FROM ONLY  
**£4.02\***  
EACH

Cat. No.	Description	1	60	120	240
EG310ULTRA	Complete Adhesive	£5.25	£4.74	£4.27	£4.02

\*Minimum order: 1 cartridge. Price based on an order quantity of 240 cartridges.

## CRL EG310 evergrip™ Mirror Adhesive

- Extra fast grab mirror adhesive
- Extra strong holding capacity
- Fast curing, with skin formation in about five minutes
- Adhesion to almost all surfaces
- Low VOC, solvent free, low odour
- 310 ml cartridge



WAS £3.09  
NOW FROM ONLY  
**£2.34\***  
EACH

Cat. No.	Description	12	60	120	240
EG310	Mirror Adhesive	£3.35	£3.04	£2.65	£2.34

\*Minimum order: 12 cartridges. Price based on an order quantity of 240 cartridges.



## CRL Standard Smooth Rod Caulking Gun

- Our best seller is also great value
- Thumb pressure release button
- Perfect for low viscosity materials

Cat. No.	Description	1	12
ER3	Standard Smooth Rod Caulking Gun	£2.83	£2.63

\*Minimum order: 1 each. Price based on an order quantity of 12.



Best seller

WAS £3.15  
NOW FROM ONLY  
**£2.63\***  
EACH

## CRL 12:1 Ratio Strap Frame Caulking Gun

- Holds standard caulking cartridges
- Best choice for low to medium viscosity materials
- Instant pressure release to prevent run-on

Cat. No.	Description	1	12
GA1203	12:1 Ratio Strap Frame Caulking Gun	£12.98	£10.51

\*Minimum order: 1 each. Price based on an order quantity of 12.



WAS £16.44  
NOW FROM ONLY  
**£10.51\***  
EACH

## CRL Blue Surface Protection Film

- 40 micron blue film
- Adhesive free
- No residue
- Static hold
- Prevents scratches
- 1,000 m length

Cat. No.	Width	1	10
2IS600B	600 mm	£94.35	£86.62
2IS1200B	1,200 mm	£188.70	£173.25
2IS1800B	1,800 mm	£276.35	£253.48

\*Minimum order: 1 roll. Price based on an order quantity of 10 rolls (2IS600B).

WAS £98.76  
NOW FROM ONLY  
**£86.62\***  
EACH



## CRL Mirabac Polypropylene Mirror Backing

- Keeps glass fragments together should mirror accidentally break, reducing the chance of personal injury
- Ready to use and easy-to-apply
- Tested to BS EN 12600
- 60 Micron
- 290 ml cartridge
- 12 per case

Cat. No.	Roll Size	1	10	20
21051	300 mm x 100 m	£17.61	£14.83	£13.03
21052	450 mm x 100 m	£25.86	£22.04	£19.31
21053	604 mm x 100 m	£35.12	£32.24	£26.11
21054	604 mm x 250 m	£94.86	£84.98	£68.96

\*Minimum order: 1 Roll. Price based on an order quantity of 20 rolls (21051).

WAS £15.14  
NOW FROM ONLY  
**£13.03\***  
EACH



# CRL Glass and Mirror Cleaner

- A long time favourite of the glass industry
- Pleasant aroma
- Available in 660 ml can or in 1 litre spray bottle

WAS £2.31  
NOW FROM ONLY  
**£1.60\***  
EACH



EBI701

EBI701T

Own Label Versions Available  
Call freephone  
00 800 04216144  
for more details

Cat. No.	Contents	12	60	144
EBI701	660 ml can	£1.90	£1.73	£1.60
EBI701T	1 litre spray bottle	£2.10	£2.01	£1.84

\*Minimum order: 12 each. Must be ordered in increments of 12 each.  
Price based on an order quantity of 144 (EBI701).



Manchester | Charles Babbage Avenue, Kingsway Business Park, Rochdale, OL16 4NW, England



Stuttgart | Boschstrasse 7 D-74360 Ilsfeld, Germany



**With daily despatches from our 110,000 square foot facilities your order can be with you quicker than ever.**

Orders are shipped daily from the CRL Warehouse via our trusted carriers. Orders are generally received next day.

See our service and shipping information at [www.crlaurence.co.uk](http://www.crlaurence.co.uk)