

Great Deals

HURRY - ENDS 31ST MARCH 2021

Aluminium Partition Posts

See Page 2

For all the latest offers,
sign up to our newsletter
at crlnews.co.uk



CRL Aluminium Partition Posts - 12"

- 5 standard configurations – end, centre, corner, 3-way, 4-way
- Aluminum tubing with full length channels for 6 mm thick glass
- Top cap and mounting base included
- Use monolithic toughened glass

FROM ONLY

£15.83*

EACH

Cat. No.	Description	1	12
D990A12E	Satin Anodised - End Part	£17.19	£15.95
D990BL12E	Matte Black - End Part	£17.05	£15.83
D990A12C	Satin Anodised - Centre Part	£20.90	£19.41
D990BL12C	Matte Black - Centre Part	£20.96	£19.46
D990A12CR	Satin Anodised - Corner Part	£20.90	£19.41
D990BL12CR	Matte Black - Corner Part	£20.96	£19.46
D990A123W	Satin Anodised - 3 Way Part	£24.63	£22.87
D990BL123W	Matte Black - 3 Way Part	£24.69	£22.93
D990A124W	Satin Anodised - 4 Way Part	£28.52	£26.48
D990BL124W	Matte Black - 4 Way Part	£28.65	£26.60

* Minimum order 1 each. Price based on an order quantity of 12 (D990BL12E)



END



CENTRE



90°
CORNER



3-WAY



4-WAY

CRL Aluminium Partition Posts - 18"

- 5 standard configurations – end, centre, corner, 3-way, 4-way
- Aluminum tubing with full length channels for 6 mm thick glass
- Top cap and mounting base included
- Use monolithic toughened glass

Cat. No.	Description	1	12
D990A18E	Satin Anodised - End Part	£17.47	£16.22
D990BL18E	Matte Black - End Part	£17.35	£16.11
D990A18C	Satin Anodised - Centre Part	£21.40	£19.87
D990BL18C	Matte Black - Centre Part	£21.49	£19.95
D990A18CR	Satin Anodised - Corner Part	£21.40	£19.87
D990BL18CR	Matte Black - Corner Part	£21.49	£19.95
D990A183W	Satin Anodised - 3 Way Part	£25.35	£23.55
D990BL183W	Matte Black - 3 Way Part	£25.45	£23.63
D990A184W	Satin Anodised - 4 Way Part	£29.48	£27.38
D990BL184W	Matte Black - 4 Way Part	£29.65	£27.53

* Minimum order 1. Price based on an order quantity of 12 (D990BL18E)

FROM ONLY
£16.11*
 EACH

CRL Aluminium Partition Posts - 24"

- 5 standard configurations – end, centre, corner, 3-way, 4-way
- Aluminum tubing with full length channels for 6 mm thick glass
- Top cap and mounting base included
- Use monolithic toughened glass

Cat. No.	Description	1	12
D990A24E	Satin Anodised - End Part	£18.46	£17.14
D990BL24E	Matte Black - End Part	£18.36	£17.05
D990A24C	Satin Anodised - Centre Part	£22.62	£21.00
D990BL24C	Matte Black - Centre Part	£22.73	£21.10
D990A24CR	Satin Anodised - Corner Part	£22.62	£21.00
D990BL24CR	Matte Black - Corner Part	£22.73	£21.10
D990A243W	Satin Anodised - 3 Way Part	£26.79	£24.87
D990BL243W	Matte Black - 3 Way Part	£26.92	£25.00
D990BL244W	Matte Black - 4 Way Part	£31.35	£29.12

CRL Aluminium Partition Posts - 30"

- 5 standard configurations – end, centre, corner, 3-way, 4-way
- Aluminum tubing with full length channels for 6 mm thick glass
- Top cap and mounting base included
- Use monolithic toughened glass

Cat. No.	Description	1	12
D990A30E	Satin Anodised - End Part	£22.78	£21.16
D990BL30E	Matte Black - End Part	£22.71	£21.09
D990A30C	Satin Anodised - Centre Part	£27.17	£25.22
D990BL30C	Matte Black - Centre Part	£27.32	£25.36
D990A30CR	Satin Anodised - Corner Part	£27.17	£25.22
D990BL30CR	Matte Black - Corner Part	£27.32	£25.36
D990A303W	Satin Anodised - 3 Way Part	£31.57	£29.31
D990BL303W	Matte Black - 3 Way Part	£50.35	£44.05
D990BL304W	Matte Black - 4 Way Part	£50.35	£44.05



CRL Sculptured Series Aluminium Partition Posts

CRL Sculptured Series Aluminium Partition Posts - 12"

- For use with 6 mm glazing
- Available in satin anodised, buffed brite anodised, duranodic bronze and matte black
- Use monolithic toughened glass

Cat. No.	Description	1	12
6406412	Satin Anodised - Centre Post	£9.49	£8.82
6409412	Matte Black - Centre Post	£9.68	£8.99
6406512	Satin Anodised - End Post	£9.27	£8.61
6409512	Matte Black - End Post	£9.45	£8.78
6406312	Satin Anodised - Corner Post	£9.49	£8.81
6409312	Matte Black - Corner Post	£9.67	£8.98

*Minimum order 1. Price based on an order quantity of 12 (6406512)

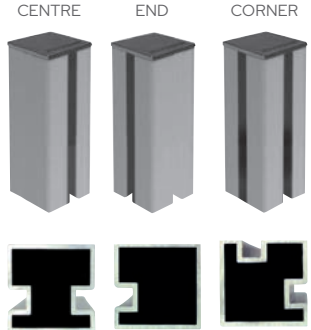

FROM ONLY
£8.61*
EACH

CRL Sculptured Series Aluminium Partition Posts - 18"

- For use with 6 mm glazing
- Available in satin anodised, buffed brite anodised, duranodic bronze and matte black
- Use monolithic toughened glass

Cat. No.	Description	1	12
6406418	Satin Anodised - Centre Post	£10.67	£9.91
6409418	Matte Black - Centre Post	£10.96	£10.18
6406518	Satin Anodised - End Post	£10.35	£9.61
6409518	Matte Black - End Post	£10.61	£9.85
6406318	Satin Anodised - Corner Post	£10.67	£9.91
6409318	Matte Black - Corner Post	£10.95	£10.17

*Minimum order quantity 1. Price based on an order quantity of 12 (6406518)

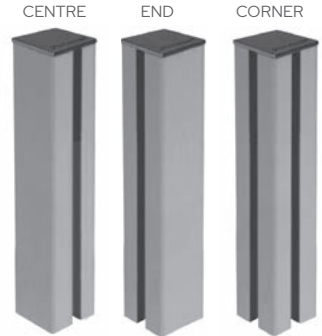

FROM ONLY
£9.61*
EACH

CRL Sculptured Series Aluminium Partition Posts - 24"

- For use with 6 mm glazing
- Available in satin anodised, buffed brite anodised, duranodic bronze and matte black
- Use monolithic toughened glass

Cat. No.	Description	1	12
6406424	Satin Anodised - Centre Post	£12.01	£11.14
6409424	Matte Black - Centre Post	£12.41	£11.53
6406524	Satin Anodised - End Post	£11.58	£10.74
6409524	Matte Black - End Post	£11.92	£11.07
6406324	Satin Anodised - Corner Post	£12.00	£11.14
6409324	Matte Black - Corner Post	£12.38	£11.49

*Minimum order quantity 1. Price based on an order quantity of 12 (6406524)

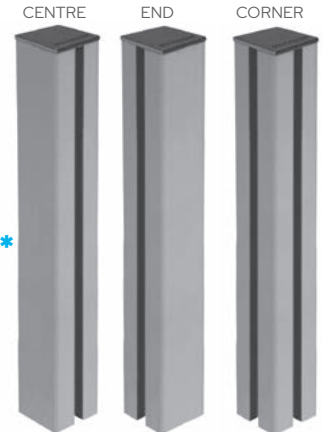

FROM ONLY
£10.74*
EACH



CRL Desktop Design System

- A new and innovative range of desktop and countertop designs from CRL
- Using a modular system the installer can create glass screens of varying heights for either fixed or freestanding solutions
- A base profile with corner connectors provides one useful solution or the same profile can be used as post supports to be fixed back to the surface or to free standing feet

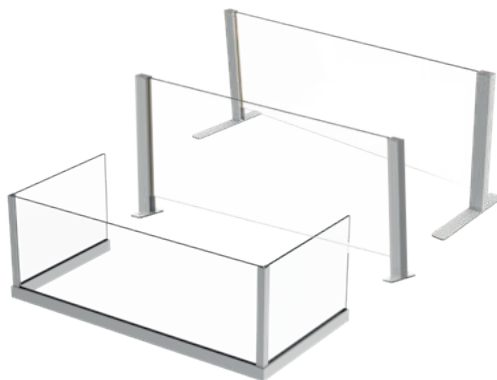

FROM ONLY
£16.54*
 EACH

Cat. No.	Description	1	6	12
DDSPROFILESA	Satin Anodised - DDS profile, 3 m	£30.72	£28.36	£26.33
DDLSLA	Satin Anodised - DDS 90 deg. profile, 3 m	£19.30	£17.82	£16.54
DDSFSA	Satin Anodised - DDS base fixed flange, with top cap	£30.68	£28.33	£26.31
DDSFBSA	Satin Anodised - DDS free standing base plate, with top cap	£46.02	£42.48	£39.45
DDS2G	DDS 2 mm thickness gasket, 3 m	£1.83	£1.69	£1.39
DDS4G	DDS 4 mm thickness gasket, 3 m	£2.40	£2.21	£2.06
DDS6G	DDS 6 mm thickness gasket, 3 m	£3.30	£3.05	£2.83
DDSIKB	DDS Internal corner bracket	£4.04	£3.73	£3.46
DDSEC	DDS End caps (set of 2)	£8.13	£7.50	£6.96
DDSPS6	DDS Plastic support, for 6 mm glass	£0.73	£0.67	£0.62
DDSPS8	DDS Plastic support, for 9 mm glass	£0.76	£0.67	£0.62

* Minimum order 1 each. Price based on an order quantity of 12 (DDLSLA)



CRL PPS Series Portable Partition Screen fitting

CRL Portable Partition Screen Fitting

- Support for Tempered or Laminated Glass or Acrylic screens
- Adjustable thickness 6 mm – 10 mm
- Anti-slip base
- Recommended: 2 Fittings / metre, 3 Fittings / 1.5 metre

FROM ONLY
£18.69*
EACH

PPS1000
Screen Height
100 cm

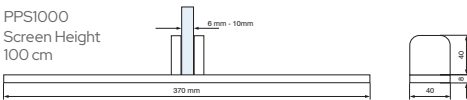

PPS800
Screen Height
80 cm

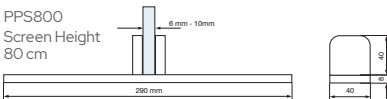

PPS600
Screen Height
60 cm

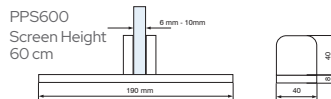

Cat. No.	Screen Height	Finish	1	10	40
PPS600MBL	Up to Max 600 mm	Matte Black	£22.09	£20.25	£18.69
PPS600BS	Up to Max 600 mm	Brushed Stainless	£23.73	£21.75	£20.07
PPS800MBL	Up to Max 800 mm	Matte Black	£25.33	£23.22	£21.43
PPS800BS	Up to Max 800 mm	Brushed Stainless	£26.51	£24.31	£22.43
PPS1000MBL	Up to Max 1000 mm	Matte Black	£27.25	£24.98	£23.06
PPS1000BS	Up to Max 1000 mm	Brushed Stainless	£27.70	£25.39	£23.44

*Minimum order: 1 each. Price based on an order quantity of 40 (PPS600MBL).

Nylon Screws for
tightening the glass

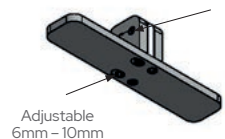

CRL 80% Alcohol Surface Sanitiser Spray

- 400 ml
- Fast application
- Covers large areas quickly and easily

FROM ONLY
£6.16*
 EACH



Cat. No.	Description	1	12	24
OB1SS	400 ml Sanitiser Spray	£7.28	£6.67	£6.16

*Minimum order: 1 each. Price based on an order quantity of 24.

CRL 70% Alcohol Hand Sanitiser Gel

- 500 ml
- Protective against harmful virus and bacteria
- Fast drying
- Provides prolonged protection to hands and skin
- Proven hand hygiene aid for instant protection and safety
- Contains an emollient to protect skin

FROM ONLY
£6.83*
 EACH



Cat. No.	Description	1	12	24
OB1HS	500 ml Sanitiser Bottle	£8.20	£7.45	£6.83

*Minimum order: 1 each. Price based on an order quantity of 24.

CRL Disposable Face Mask

- Pack of 50

FROM ONLY
£36.96
 EACH



Cat. No.	Description	50
CRLMASK	50 Face Masks	£36.96

*Minimum order: 50 each. Price based on an order quantity of 50.

CRL Wood's Powr-Grip® Vacuum Cup

- 203 mm diameter pad
- Check valve allows re-pumping without loss of remaining vacuum
- Release valve lever permits quick and complete release
- Fast attachment on smooth, non-porous flat surfaces
- Red-line indicator warns user of any vacuum loss
- Supplied with protective carrying case
- 57 kg lifting capacity



Cat. No.	Description	1	5	10
N4000	ABS Handle Vacuum Cup	£38.10	£34.63	£31.75
N4950	Metal Handle Vacuum Cup	£58.97	-	-

*Minimum order: 1 each. Price based on an order quantity of 10 (N4000).



~~WAS £35.28~~
NOW FROM ONLY
£31.75*
 EACH

CRL Aluminium Frame Vacuum Lifters

- Sturdily built traditional design plastic and aluminium frame
- Each suction pad operates separately
- 114 mm diameter suction pads

~~WAS £34.36~~

NOW FROM ONLY

£30.13*

EACH

Cat. No.	Description	1	6
05062	2 Vacuum Pads - Aluminium	£35.23	£32.03
05062P	2 Vacuum Pads - Plastic	£33.11	£30.13
05063	3 Vacuum Pads - Aluminium	£41.05	£36.93
05063P	3 Vacuum Pads - Plastic	£46.04	£38.93

*Minimum order: 1. Price based on an order quantity of 6 (05062P).



CRL All Terrain Dolly

- Exclusive to CRL
- Terrific for moving heavy glass panels around the job site
- Goes where other glass dollies won't
- Frame in solid aluminium
- Built-In 203 mm Wood's Powr-Grip® Vacuum Cup
- Includes a set of our RB200 Roller Blocks
- 181 kg load capacity

~~WAS £550.10~~

NOW ONLY

£399.64*

EACH



Included

Cat. No.	Description	1
ATD1	All Terrain Dolly	£399.64

*Minimum order: 1. Price based on an order quantity of 1.

CRL Roller Blocks

- Roller design lets you rotate heavy glass panels with ease
- Turn them over to use as resting blocks
- Rubber base ensures traction

~~WAS £52.67~~

NOW ONLY

£45.42*

PER PAIR



Cat. No.	Description	1
RB200	Roller Blocks	£45.42

*Minimum order: 1. Price based on an order quantity of 1.

CRL Glasstrax Glass Dolly

- Self clamping action locks loads up to 50.8 mm thick
- One person can load and manoeuvre
- Safe glass transport with large 272 kg capacity

ONLY

£501.36*

EACH



Cat. No.	Description	1
GT02	Glass Dolly	£501.36

*Minimum order: 1. Price based on an order quantity of 1.

CRL Corner Protectors

- Designed to protect glass and mirror edges during shipping, handling or storing
- Will not scratch or damage glass or mirror surfaces, and help protect large cut-offs from breakage or becoming scrap
- Protectors are reusable, they simply slide on and off
- 1,000 per box



PRICE PER BOX OF 1000

Cat. No.	Glass Thickness	1	10
1463004K	4 mm	£58.20	£52.27
1463006K	6 mm	£52.63	£47.48
1463008K	8 mm	£47.48	£42.75
1463010K	10 mm	£54.38	£48.93
1463012K	12 mm	£55.52	£49.96

*Minimum order: 1 box. Price based on an order quantity of 10 boxes (1463008K).

~~WAS £64.77~~
NOW FROM ONLY
£42.75*
 PER BOX

CRL Blue Transport Pads

- Medium density
- Low-tack, pressure sensitive adhesive
- Leaves no adhesive residue or ghosting marks

~~WAS £53.34~~

NOW FROM ONLY

£44.29*

EACH

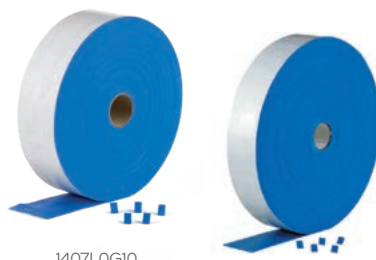

1407LOG10

1407LOG20

Cat. No.	Size	Quantity	1	5
1407LOG10	24 x 19 x 4 mm	10,000 pads per roll	£48.41	£44.29
1407LOG20	21 x 18 x 4 mm	20,000 pads per roll	£81.37	£75.19

*Minimum order quantity: 1 roll. Price based on an order quantity of 5 rolls (1407LOG10)



CRL Neutral Cure Construction Silicone

- Neutral cure, low modulus silicone
- Versatile sealant
- Cures under the influence of humidity to form a durable elastic rubber seal
- Specifically developed for durable elastic sealing of expansion joints in concrete, brickwork, curtain wall constructions, kitchens, bathrooms, showers, industrial applications and glazing systems
- UV, water, weather and mould resistant
- Available in clear, black and white
- 300 ml cartridge
- 12 per case

~~WAS £1.97~~
NOW FROM ONLY
£1.84*
 EACH

Cat. No.	Colour	1	12	120	240
CRLNCSC	Clear	£2.32	£2.14	£1.99	£1.84
CRLNCSBL	Black	£2.32	£2.14	£1.99	£1.84
CRLNCSSW	White	£2.32	£2.14	£1.99	£1.84

*Minimum order: 1 cartridge. Price based on an order quantity of 240 cartridges.



CRL MS Polymer Mirror Fix

- High quality professional mirror and painted glass adhesive developed with MS Polymer hybrid technology
- Adheres without the use of primer to most non-porous substrates
- Free of isocyanates, solvents, silicones and plasticiser
- No shrinkage
- UV, water, weather and mould resistant
- Mirrors should be mechanically supported while the adhesive is curing
- Colour: White
- 290 ml cartridge
- 12 per case



WAS £2.04
NOW FROM ONLY
£1.91*
EACH

Cat. No.	Colour	1	12	60	120
EGMSFIX	White	£2.39	£2.20	£2.04	£1.91

*Minimum order: 1 cartridge. Price based on an order quantity of 120 cartridges.

CRL EG310ULTRA Complete Adhesive

- MS Polymer based
- Neutral curing and odourless
- Cures with atmospheric moisture
- Super-fast bonding of mirrors, glass, wood, composite panels and metal to a range of substrates
- Free of silicone and isocyanides
- 290 ml cartridge
- 12 per case



WAS £5.24
NOW FROM ONLY
£4.02*
EACH

Cat. No.	Colour	1	60	120	240
EG310ULTRA	Complete Adhesive	£5.25	£4.74	£4.27	£4.02

*Minimum order: 1 cartridge. Price based on an order quantity of 240 cartridges.

CRL EG310 evergrip™ Mirror Adhesive

- Extra fast grab mirror adhesive
- Extra strong holding capacity
- Fast curing, with skin formation in about five minutes
- Adhesion to almost all surfaces
- Low VOC, solvent free, low odour
- 310 ml cartridge



WAS £3.09
NOW FROM ONLY
£2.34*
EACH

Cat. No.	Colour	12	60	120	240
EG310	Mirror Adhesive	£3.35	£3.04	£2.65	£2.34

*Minimum order: 12 cartridges. Price based on an order quantity of 240 cartridges.

CRL Standard Smooth Rod Caulking Gun

- Our best seller is also great value
- Thumb pressure release button
- Perfect for low viscosity materials

Cat. No.	Description	1	12
ER3	Standard Smooth Rod Caulking Gun	£2.83	£2.63

*Minimum order: 1 each. Price based on an order quantity of 12.



Best seller

WAS £3.15
NOW FROM ONLY
£2.63*
EACH

CRL 12:1 Ratio Strap Frame Caulking Gun

- Holds standard caulking cartridges
- Best choice for low to medium viscosity materials
- Instant pressure release to prevent run-on

Cat. No.	Description	1	12
GA1203	12:1 Ratio Strap Frame Caulking Gun	£12.98	£10.51

*Minimum order: 1 each. Price based on an order quantity of 12.



WAS £16.44
NOW FROM ONLY
£10.51*
EACH

CRL Blue Surface Protection Film

- 40 micron blue film
- Adhesive free
- No residue
- Static hold
- Prevents scratches
- 1,000 m length

Cat. No.	Width	1	10
2IS600B	600 mm	£94.35	£86.62
2IS1200B	1,200 mm	£188.70	£173.25
2IS1800B	1,800 mm	£276.35	£253.48

*Minimum order: 1 roll. Price based on an order quantity of 10 rolls (2IS600B).



WAS £98.76
NOW FROM ONLY
£86.62*
EACH

CRL Mirabac Polypropylene Mirror Backing

- Keeps glass fragments together should mirror accidentally break, reducing the chance of personal injury
- Ready to use and easy-to-apply
- Tested to BS EN 12600
- 60 Micron
- 290 ml cartridge
- 12 per case

Cat. No.	Roll Size	1	10	20
21051	300 mm x 100 m	£17.61	£14.83	£13.03
21052	450 mm x 100 m	£25.86	£22.04	£19.31
21053	604 mm x 100 m	£35.12	£32.24	£26.11
21054	604 mm x 250 m	£94.86	£84.98	£68.96

*Minimum order: 1 Roll. Price based on an order quantity of 20 rolls (21051).



WAS £15.14
NOW FROM ONLY
£13.03*
EACH

CRL Glass and Mirror Cleaner

- A long time favourite of the glass industry
- Ammoniated formula with a pleasant aroma
- Available in 660 ml can or in 1 litre spray bottle

WAS £2.31
NOW FROM ONLY
£1.60*
EACH



EB1701

EB1701T

Own Label Versions Available
Call freephone
00 800 04216144
for more details

Cat. No.	Contents	12	60	144
EB1701	660 ml can	£1.90	£1.73	£1.60
EB1701T	1 litre spray bottle	£2.10	£2.01	£1.84

*Minimum order: 12 each. Must be ordered in increments of 12 each.
Price based on an order quantity of 144 (EB1701).

CRL Wall Mount Brackets

- Component to provide fixed panel support for enclosures not going to the ceiling
- Compatible with CRL support bars
- Chrome finish

WAS £5.15
 NOW FROM ONLY
£4.45*
 EACH



Cat. No.	Description	1	6
SQ46CH	Square Wall Mount Bracket	£7.90	£7.15
SQJ46CH	Square Slimline Wall Mount Bracket	£5.53	£4.97
S12CH	Round Wall Mount Bracket	£4.91	£4.45

*Minimum order: 1. Price based on an order quantity of 6 (S12CH).

CRL Brackets

- For use with 6 to 8 mm glass
- Component to provide fixed panel support for enclosures not going to the ceiling
- No hole required in the glass
- Chrome finish

WAS £8.78
 NOW FROM ONLY
£7.67*
 EACH



Cat. No.	Description	1	6
SQ41CH	Swivelling U-Bracket	£12.92	£12.01
SQJ41CH	Swivelling Slimline U-Bracket	£8.18	£7.67
S4VCH	Round Swivelling Stabiliser	£11.55	£10.49

*Minimum order: 1. Price based on an order quantity of 6 (SQJ41CH).

CRL Support Bars

- Component to provide fixed panel support for enclosures not going to the ceiling
- Compatible with a large range of CRL brackets to meet your needs
- Chrome finish

WAS £16.86
 NOW FROM ONLY
£15.13*
 EACH



Cat. No.	Description	Size	1	6
S1CH	1 m Round Support Bar	19 mm	£16.34	£15.13
S2CH	1,295 mm Round Support Bar	19 mm	£21.21	£19.19
SQ39CH	1 m Square Support Bar	19 mm	£27.94	£26.00
SQJ39CH	1 m Square Slimline Support Bar	15 mm	£28.66	£26.62

*Minimum order: 1. Price based on an order quantity of 6 (S1CH).

CRL Aluminium U-Channel for 6 to 8mm Glass

- Available in 2.49 m lengths
- Wet glaze with clear silicone
- Extremely versatile extrusion in up to 5 popular finishes - see crlaurence.co.uk

WAS £9.16
 NOW FROM ONLY
£8.49*
 EACH

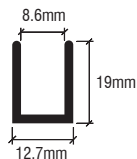

Cat. No.	Finish	1	10	40	80	120
SDCD516BA	Bright Anodised	£11.32	£10.29	£9.43	£8.71	£8.49
SDCD516BN	Brushed Nickel	£11.18	£10.24	£9.46	£9.22	£8.79
SDCD516MBL	Matte Black	£25.61	£21.33	£18.28	£16.01	£14.23

*Minimum order: 1 each. Price based on an order quantity of 120 (SDCD516BA).

CRL Aluminium U-Channel for 10mm Glass

- Wet glazed with clear silicone to secure glass
- Available in 2.49 m and 3.65 m stock lengths
- Available in up to 17 finishes - see crlaurence.co.uk

~~WAS £9.88~~
NOW FROM ONLY
£8.89*
EACH

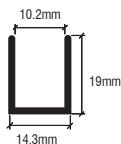
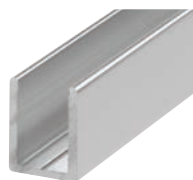

SDCD38

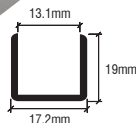
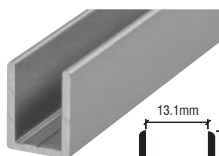

SDCD12

Cat. No.	Finish	Length	Depth	1	10	40	80	120
SDCD38BA	Bright Anodised	2.49 m	19 mm	£11.66	£10.98	£9.88	£9.38	£9.08
SDCD38BN	Brushed Nickel	2.49 m	19 mm	£12.51	£9.88	£9.38	£9.14	£8.89
SDCD38MBL	Matte Black	2.49 m	19 mm	£24.48	£21.75	£19.58	£17.80	£16.32
SDCD3812BA	Bright Anodised	3.65 m	19 mm	£20.41	£18.38	£16.68	£15.35	£14.11
SDCD3812BN	Brushed Nickel	3.65 m	9.5 mm	£21.16	£18.77	£17.28	£15.84	£14.54
SDCD3812MBL	Matte Black	3.65 m	9.5 mm	£35.86	£29.88	£26.89	£24.45	£21.52
SDCD12BA	Bright Anodised	2.49 m	19 mm	£12.66	£11.13	£10.21	£9.67	£9.18
SDCD12BN	Brushed Nickel	2.49 m	19 mm	£13.30	£12.08	£11.07	£10.23	£9.49
SDCD12MBL	Matte Black	2.49 m	19 mm	£25.61	£21.57	£18.61	£16.39	£14.64

*Minimum order: 1 each. Price based on an order quantity of 120 (SDCD38BN).

CRL Dry Glaze U-Channel With Vinyl for 8 and 10mm Glass

- Clear vinyls secure glass in channel and eliminate the need for messy silicone
- Recess in bottom channel hides caulk line
- DUC38 can be used with 8 mm glass where RV8DUC rigid vinyl is used (available separately)
- Individually packaged
- 2.49 m length

~~WAS £19.19~~
NOW FROM ONLY
£14.49*
EACH



NOTE: glass is not included

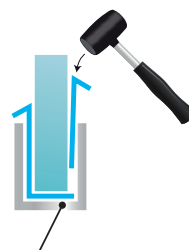
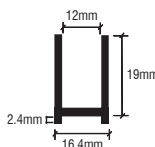

Complete by securing U-Channel

Cat. No.	Finish	1	10	50
DUC516BA	Bright Anodised	£20.42	£17.52	£14.49
DUC516BN	Brushed Nickel	£22.71	£20.52	£18.74
DUC38BA	Bright Anodised	£18.56	£17.54	£16.59
DUC38BN	Brushed Nickel	£21.13	£20.25	£18.72

*Minimum order: 1 each. Price based on an order quantity of 50 (DUC516BA).

CRL Clear 'Y' Jamb Seal With Soft Leg

- Soft vinyl single leg for quieter door closure
- Snaps onto fixed panel
- For 180° inline glass-to-glass applications
- Suggested gap: 4.7 mm
- 2.49 m stock length

~~WAS £8.95~~
NOW FROM ONLY
£6.39*
 EACH

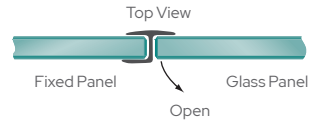
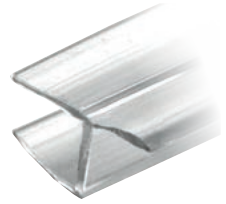

Cat. No.	Glass Thickness	1	10	40
PCC10	10 mm	£8.12	£7.13	£6.39

*Minimum order: 1 each. Price based on an order quantity of 40.

CRL Clear Vinyl Bulb Seal

- Can be used on inswing and outswing doors
- Suggested gap: 6 to 8 mm
- 2.49 m stock length

~~WAS £6.61~~
NOW FROM ONLY
£6.33*
 EACH

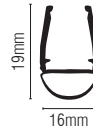

Cat. No.	Glass Thickness	1	10	40
PCR10	10 mm	£7.42	£6.70	£6.33

*Minimum order: 1 each. Price based on an order quantity of 40.

CRL Clear Co-Extruded Bottom Wipe With Drip Rail

- Snaps on bottom of door
- 45° drip rail assists in deflecting water back into the enclosure
- Suggested gap: 11 mm
- 2.49 m stock length

~~WAS £5.67~~
NOW FROM ONLY
£5.29*
 EACH

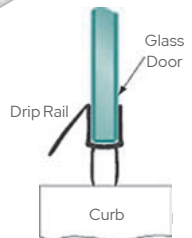
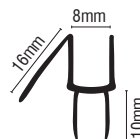

Cat. No.	Glass Thickness	1	10	40
P990WS	10 mm	£6.37	£5.77	£5.29

*Minimum order: 1 each. Price based on an order quantity of 40.

CRL Geneva Series Shower Hinges

- For 8 to 12 mm toughened safety glass
- Our most popular hinge series
- Square corner hinge design
- Self-centering when within 15° of closed position
- Construction: solid brass



GEN037

GEN044

GEN180

Cat. No.	Finish	Length	1	16
GEN037CH	Wall Mount Full Back Plate Hinge	Chrome	£24.41	£22.99
GEN037BN	Wall Mount Full Back Plate Hinge	Brushed Nickel	£24.41	£22.99
GEN037MBL	Wall Mount Full Back Plate Hinge	Matte Black	£34.53	£31.02
GEN044CH	Wall Mount Offset Back Plate Hinge	Chrome	£24.78	£22.98
GEN044BN	Wall Mount Offset Back Plate Hinge	Brushed Nickel	£24.78	£22.98
GEN044MBL	Wall Mount Offset Back Plate Hinge	Matte Black	£33.63	£31.85
GEN180CH	180 Degree Glass-to-Glass Hinge	Chrome	£33.49	£31.78
GEN180BN	180 Degree Glass-to-Glass Hinge	Brushed Nickel	£33.49	£31.78
GEN180MBL	180 Degree Glass-to-Glass Hinge	Matte Black	£40.92	£38.12

*Minimum order: 1 each. Price based on an order quantity of 16 (GEN044CH).

Maximum Capacities	8 mm to 12 mm glass	
	Weight	Door Width
Using Two Hinges	36 kg	711 mm
Using Three Hinges	54 kg	813 mm

~~WAS £26.09~~
NOW FROM ONLY
£22.98*
EACH

NOTE: Do not exceed maximum door weight or width when choosing proper quantity of hinges.

CRL Geneva Clamps

- For 8 to 12 mm toughened safety glass
- Clamps match configuration of our popular Geneva hinge plus many more
- Square corner clamp design
- Construction: solid brass



GE90S

GE090

~~WAS £30.68~~
NOW FROM ONLY
£27.33*
EACH

Cat. No.	Description	Finish	1	10	50
GE90SCH	Wall Mount Geneva Glass Clamp	Chrome	£31.43	£29.23	£27.33
GE90SBN	Wall Mount Geneva Glass Clamp	Brushed Nickel	£32.94	£30.08	£28.83
GE090CH	90° Glass-to-Glass Geneva Clamp	Matte Black	£37.92	£34.40	£33.60
GE090BN	90° Glass-to-Glass Geneva Clamp	Brushed Nickel	£40.01	£37.19	£34.76

*Minimum order: 1 each. Price based on an order quantity of 50 (GE90SCH).

CRL Shower Door Knob

- For 6 to 12 mm toughened safety glass
- Attractive ribbed appearance
- 12 mm diameter hole required

~~WAS £12.58~~
NOW FROM ONLY
£11.29* EACH



SDK160



SDK106

Cat. No.	Description	Finish	1	10	50
SDK160CH	Back-to-Back Square Style Knob	Chrome	£17.18	£15.29	£13.76
SDK160BN	Back-to-Back Square Style Knob	Brushed Nickel	£17.18	£15.29	£13.76
SDK160MBL	Back-to-Back Square Style Knob	Matte Black	£20.21	£19.20	£17.07
SDK106CH	Back-to-Back Contemporary Style Knob	Chrome	£12.95	£12.23	£11.29
SDK106BN	Back-to-Back Contemporary Style Knob	Brushed Nickel	£14.41	£13.20	£12.20
SDK106MBL	Back-to-Back Contemporary Style Knob	Matte Black	£14.86	£14.49	£13.38

*Minimum order: 1 each. Price based on an order quantity of 50 (SDK106CH).

CRL Back-To-Back Paddle Knob

- For 6 to 12 mm toughened safety glass
- Flat 'paddle' shape appearance with square corners
- Two 12 mm diameter holes required

~~WAS £32.34~~
NOW FROM ONLY
£28.55* EACH



Cat. No.	Description	Finish	1	10	50
SDK180CH	Back-to-Back Paddle Style	Chrome	£33.81	£30.60	£28.55
SDK180BN	Back-to-Back Paddle Style	Brushed Nickel	£42.86	£39.20	£34.76
SDK180MBL	Back-to-Back Paddle Style	Matte Black	£42.67	£37.47	£34.93

*Minimum order: 1 each. Price based on an order quantity of 50 (SDK180CH).

CRL Ladder Style Back-To-Back Pull Handle

- For 8 to 12 mm toughened safety glass
- Mounting holes 152 and 203 mm centre-to-centre
- Two 12 mm diameter hole required

~~WAS £50.89~~
NOW FROM ONLY
£48.53* EACH



LP6X6MBL

LP8X8MBL

Cat. No.	Description	Finish	1	10	50
LP6X6CH	152 mm Handle	Chrome	£53.92	£51.10	£48.53
LP6X6BN	152 mm Handle	Brushed Nickel	£53.92	£51.10	£48.53
LP6X6MBL	152 mm Handle	Matte Black	£58.97	£54.11	£50.69
LP8X8CH	203 mm Handle	Chrome	£60.30	£56.45	£53.07
LP8X8BN	203 mm Handle	Brushed Nickel	£60.30	£56.45	£53.07
LP8X8MBL	203 mm Handle	Matte Black	£64.28	£59.43	£56.25

*Minimum order: 1 each. Price based on an order quantity of 50 (LP6X6CH).

CRL BM Series Back-To-Back Pull Handle

- For 6 to 12 mm toughened safety glass
- Mounting holes 152 and 203 mm centre-to-centre
- With metal washers
- Two 12 mm diameter holes required

~~WAS £15.85~~
NOW FROM ONLY
£14.27* EACH

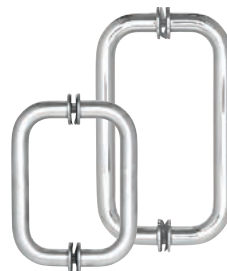

BM6X6MBL

BM8X8MBL

Cat. No.	Description	Finish	1	10	50
BM6X6CH	152 mm Handle	Chrome	£17.43	£15.70	£14.27
BM6X6BN	152 mm Handle	Brushed Nickel	£17.43	£15.70	£14.27
BM6X6MBL	152 mm Handle	Matte Black	£17.63	£16.10	£14.41
BM8X8CH	203 mm Handle	Chrome	£19.65	£17.59	£16.08
BM8X8BN	203 mm Handle	Brushed Nickel	£19.65	£17.59	£16.08
BM8X8MBL	203 mm Handle	Matte Black	£19.91	£18.07	£16.79

*Minimum order: 1 each. Price based on an order quantity of 50 (BM6X6CH).



WAS £211.23
NOW FROM ONLY
£186.43*

CRL Hydroslide Series Sliding Shower Door System

- Excellent design for compact areas
- Quick and easy installation
- Clean, sleek lines
- Available in four stock finishes, custom finishes available
- Custom units available by special order
- Glass fabrication required
- For use with 8 mm to 10 mm monolithic toughened glass

Maximum Capacities	8 mm to 10 mm	
	Weight	Door Width
HYDK60	40 kg	1520 mm
HYDK84	40 kg	2130 mm

NOTE: Do not exceed maximum door weight or width.



Image shown here:
HYDA9

Standard 180 Degree Kit Includes:

- 1 - Sliding glass door upper track
- 2 - Hangers for sliding glass door
- 2 - Sliding glass door rollers
- 2 - Sliding glass door roller stops
- 1 - Sliding glass door floor guide
- 2 - 90 degree wall-to-upper track connectors
- 2 - 180 degree glass-to-sliding track connectors
- 1 - 914 mm half-round SDT980 threshold
- 1 - 2489 mm DK98L L-seal for wall

NOTE: Bottom fixed glass attachments, handles or knobs must be ordered separately.

90 Degree** Wall-to-Glass Accessory Kit Includes:

- 1 - 90 degree glass-to-sliding track connector
- 1 - 90 degree wall-to-glass bracket

**90 degree units require that you order one 180 degree Standard Kit plus one 90 degree Accessory Kit

Cat. No.	Description	Finish	1	6
HYDK60CH	Standard 180 degree kit 1524 mm	Bright Anodised / Chrome	£201.88	£186.43
HYDK60BN	Standard 180 degree kit 1524 mm	Brushed Nickel	£224.54	£211.15
HYDK84CH	Standard 180 degree kit 2134 mm	Bright Anodised / Chrome	£218.36	£202.91
HYDK84BN	Standard 180 degree kit 2134 mm	Brushed Nickel	£239.99	£225.57
HYDA9CH	90 degree wall-to-glass accessory kit	Bright Anodised / Chrome	£55.53	£52.31
HYDA9BN	90 degree wall-to-glass accessory kit	Brushed Nickel	£64.92	£61.18

*Minimum order: 1 each. Price based on an order quantity of 6 (HYDK60CH).





WAS £264.52
NOW FROM ONLY
£224.54*

CRL Deluxe Serenity Series Sliding Shower Door System

- Unique 180° system with rollers above and below the header bar
- System features one sliding door and one fixed panel
- Fixed and sliding glass panels are reversible for installation (glass not included)
- Use of minimal hardware gives door an almost floating appearance
- Glass fabrication required
- Accessory kit available for 90° return panels (SER90XX)
- For use with 8 to 10 mm monolithic toughened glass

Deluxe 180 Degree Kit Includes:

- 1 - 2 m length header support bar
- 4 - Rollers
- 1 - Stopper
- 2 - Track holder fittings for wall
- 2 - Track holder fittings for fixed panel
- 1 - Thru-glass pull
- 1 - Door guide
- 1 - 2.16 m length clear L-jamb



Image shown here:
SER90BS

	8 mm to 10 mm	
	Weight	Door Width
Maximum Capacities	40 kg	762 mm



Cat. No.	Description	Finish	1	6
SER78BS	Deluxe 180 Degree Kit	Brushed Stainless	£250.29	£224.54
SER78PS	Deluxe 180 Degree Kit	Polished Stainless	£264.71	£245.14
SER78MBL	Deluxe 180 Degree Kit	Matte Black	£269.86	£249.26
SER90BS	90 Degree Accessory Kit	Brushed Stainless	£7.55	£6.97
SER90PS	90 Degree Accessory Kit	Polished Stainless	£8.21	£7.81
SER90MBL	90 Degree Accessory Kit	Matte Black	£10.08	£9.03
SERAHW2BS	Track Holder Fittings for Wall	Brushed Stainless	£21.69	£19.77
SERAHW2PS	Track Holder Fittings for Wall	Polished Stainless	£27.52	£23.06
SERAHW2MBL	Track Holder Fittings for Wall	Matte Black	£28.59	£25.53

*Minimum order: 1 each. Price based on an order quantity of 6 (SER78BS).

CRL COMPACT-X

Sliding Door System

CRL COMPACT-X is a compact sliding solution for frameless glass panels, combining the latest technology with an attractive minimalist design. The system is quick and easy to install with double soft close.

Features

- Quick and easy to install
- Suitable for ceiling, glass and wall mounted applications
- Vertical adjustment
- For use with 8 mm, 8.76 mm, 10 mm and 10.76 mm glass
- Available in Brushed Nickel and Satin Anodised finishes
- Available in a 3 metre kit as well as 3 and 5 metre kits with fixed panel
- Option to install Bi-parting doors by purchasing extra set of clamps
- Can be used for both commercial and shower applications

Enhanced Double Soft Close System

Door System Limitations	
Maximum Door Weight	70 kg
Minimum Panel Width	635 mm
Maximum Track Length	5000 mm



CRL Brooklyn

A matte black frame system for sliding doors

New for 2020, CRL Brooklyn is an innovative, style-led sliding door frame system designed for both residential and commercial use. Allowing practical room partitioning, while still retaining a sense of space, Brooklyn is set to be one of the most popular systems available.

Elegance in the home

Create the ideal interior door system, combining the minimalistic style of a matte black frame with a door design that makes the very best use of natural light within a home.

Commercial style

Perfect for use in restaurants and office environments, the Brooklyn system is an ideal partitioning solution in locations where an inviting sense of light is key.

Developed with classic lines, the system complements a wide range of interior styles.



Juliette Balconies

CRL Juliette Balcony Connector

- For use with the 48.3 mm EUGR20 Cap Rail
- 316 Grade Stainless Steel
- Tested to a width of 2400 mm certificate available
- Single pane of glass must be used for all widths of Juliette Balconies when using these products

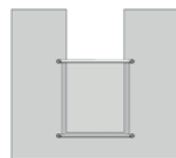
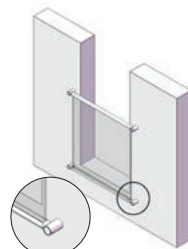
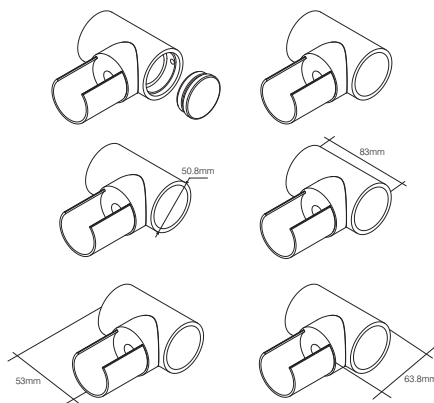

Cat. No.	Finish	1	10
EUGR20JBS	Brushed Stainless Steel	£58.92	£55.66
EUGR20JPS	Polished Stainless Steel	£59.97	£57.28

*Minimum order: 1 each. Price based on an order quantity of 10 (EUGR20JBS).

~~WAS £59.00~~
NOW FROM ONLY
£55.66*
 EACH

48.3 mm Diameter Cap Rail

- For 12 mm to 25.52 mm glass
- Connects to a variety of fabricated corners and end caps

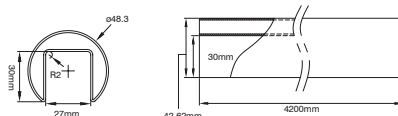
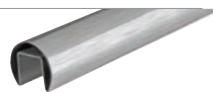

~~WAS £47.65~~
NOW FROM ONLY
£45.21*
 EACH

Cat. No.	Finish	Length	1	6
EUGR20BS	Brushed Stainless Steel	3 m	£46.11	£45.21
EUGR20BS14	Brushed Stainless Steel	4.2 m	£64.34	£60.33
EUGR20PS	Polished Stainless Steel	3 m	£83.87	£78.52
EUGR20PS14	Polished Stainless Steel	4.2 m	£117.18	£109.87

*Minimum order: 1 length. Price based on an order quantity of 6 (EUGR20BS).

Glass Thickness



12 mm to 25.52 mm



Paris Balconies

CRL Fascia Mount Paris Balcony System

- Height 1,200 mm
- Fixes to brickwork, concrete and steel
- Tempered laminated glass
- Tested to BS6180:2011
- Substrate fixings not included
- Profiles can be cut to size on site

~~WAS £106.83~~
NOW FROM ONLY
£90.81*
 EACH

Cat. No.	Glass Thickness	Colour	Max Span	1	5
PARIS1GR	13.52 & 17.52 mm	Grey RAL 7016	13.52 mm = 1,620 mm, 17.52 mm = 2,150 mm	£112.47	£98.37
PARIS1W	13.52 & 17.52 mm	White RAL 9016	13.52 mm = 1,620 mm, 17.52 mm = 2,150 mm	£114.29	£100.00
PARIS2GR	21.52 mm	Grey RAL 7016	2,600 mm	£103.77	£90.81
PARIS2W	21.52 mm	White RAL 9016	2,600 mm	£105.60	£92.42

*Minimum order: 1 length. Price based on an order quantity of 5 (PARIS2GR).

CRL Reveal Mount Paris Balcony System

- Height 1,200 mm
- Fixes to brickwork, concrete and steel
- Tempered laminated glass
- Tested to BS6180:2011
- Substrate fixings not included
- Profiles can be cut to size on site

~~WAS £110.62~~
NOW FROM ONLY
£94.03*
 EACH

Cat. No.	Glass Thickness	Colour	Max Span	1	5
PARIS3GR	13.52 & 17.52 mm	Grey RAL 7016	13.52 mm = 1,620 mm, 17.52 mm = 2,150 mm	£116.13	£101.61
PARIS3W	13.52 & 17.52 mm	White RAL 9016	13.52 mm = 1,620 mm, 17.52 mm = 2,150 mm	£117.88	£103.14
PARIS4GR	21.52 mm	Grey RAL 7016	2,600 mm	£107.46	£94.03
PARIS4W	21.52 mm	White RAL 9016	2,600 mm	£109.32	£95.65

*Minimum order: 1 length. Price based on an order quantity of 5 (PARIS4GR).





CRL Posiglaze Surface Mount Base Shoe



For a standard 3 m surface mount installation, the following components will be required:

- 1 x 3 m Surface Mount Base Shoe
- 2 x 3 m Top Clip
- 1 x Clamp kit to suit specified glass thickness
- 1 x Spanner

CRL Posiglaze Surface Mount Base Shoe

- For use with 12 to 21.52 mm glass
- Pre-drilled first hole from edge of base shoe: 100 mm
- Pre-drilled centre-to-centre hole distance: 200 mm
- Hole suited to 12 mm fixing bolt and counter bored to sink the bolt head
- 3 m length

WAS £180.25

NOW FROM ONLY

£170.98*

EACH



Cat. No.	Description	Finish	1	6
EPGDSA	Surface Mount Base Shoe	Steel Anodised	£182.31	£170.98

*Minimum order: 1 each. Price based on an order quantity of 6.

CRL Posiglaze Top Clip

- Holds the gasket
- Presses onto the channel at the end of the installation
- Covers the clamps from and prevents debris from entering the channel
- 3 m length

WAS £12.88

NOW FROM ONLY

£11.75*

EACH



Cat. No.	Description	1	6
EPGTSSA	Top Clip	£12.29	£11.75

*Minimum order: 1 each. Price based on an order quantity of 6.

CRL Posiglaze Clamp Kits (inc. clamps, gasket, bars, bolts)

- Includes enough components to suit a 3 m length of base shoe
- Glass clamps have a ± 1 mm tolerance to accommodate varying interlayer thicknesses in the glass
- Includes the clamp bars which sit into the top mould of the clamps and the clamp bolts which screw into the bars and are then undone to hold the glass in place. These are undone and tightened each side allowing the glass alignment
- Includes 6 m gasket to suit glass thickness



WAS £50.38

NOW FROM ONLY

£47.01*

EACH

Cat. No.	Description	1	6
EPG12SET	Clamp Kits for 12 mm glass	£50.43	£47.01

*Minimum order: 1 each. Price based on an order quantity of 6.

CRL Posiglaze Spanner

- With angle to reach the clamp to tighten/loosen the glass
- Material: Steel

WAS £5.83

NOW FROM ONLY

£5.54*

EACH



Cat. No.	Description	1	6
EPGSPAN	Spanner	£5.95	£5.54

*Minimum order: 1 each. Price based on an order quantity of 6.



CRL Spig-Lite Pro



For a standard 1m glass balustrade, the following components will be required:

- 2 x Spigots
- 2 x Clamps
- 4 x Top Clips
- 1 x 1m length Gasket
- 1 x Spanner

CRL Spig-Lite Spigot

- For use with 12 to 21.52 mm glass
- Predrilled in the centre
- Pre-finished Graphite Grey

Cat. No.	Description	1	6
ESPIG	Spigot	£40.17	£38.11

*Minimum order: 1 each. Price based on an order quantity of 6.

~~WAS £39.48~~
NOW FROM ONLY
£38.11*
 EACH



CRL Spig-Lite Clamp Kits

- Glass clamps have a ± 1 mm tolerance to accommodate varying interlayer thicknesses in the glass
- Includes the clamp bars which sit into the top mould of the clamps and the clamp bolts which screw into the bars and are then undone to hold the glass in place. These are undone and tightened each side allowing the glass alignment.

Cat. No.	Description	1	6
ESPIG12C	Clamp Kits	£8.47	£7.75

*Minimum order: 1 each. Price based on an order quantity of 6.

~~WAS £8.57~~
NOW FROM ONLY
£7.75*
 EACH



CRL Spig-Lite Top Clip

- Holds the gasket
- Pressed onto the channel at the end of the installation
- Pre-finished Graphite Grey

Cat. No.	Description	1	6
ESPIGTCL	Top Clip	£2.38	£2.22

*Minimum order: 1 each. Price based on an order quantity of 6.

~~WAS £2.35~~
NOW FROM ONLY
£2.22*
 EACH



CRL Spig-Lite Gasket

- 1 m length

Cat. No.	Description	1	6
ESPIGGL	Gasket	£2.01	£1.98

*Minimum order: 1 each. Price based on an order quantity of 6.

FROM ONLY
£1.98*
 EACH



CRL Spig-Lite Spanner

- With angle to reach the clamp to tighten/loosen the glass
- Material: Steel

Cat. No.	Description	1	6
EPGSPAN	Spanner	£5.95	£5.54

*Minimum order: 1 each. Price based on an order quantity of 6.

~~WAS £5.83~~
NOW FROM ONLY
£5.54*
 EACH



CRL Large D Shape Flat Back Glass Clamps

- For use on mezzanines, partitions, railings and windbreaks
- For 8 to 12.76 mm toughened or laminated glass
- Steel pin included for additional glass support
- Size 63 x 45 x 30 mm
- Sold individually
- Matching flat rubber gaskets available, sold as a pair

~~WAS £2.04~~
NOW FROM ONLY
£1.96*
EACH



Also available in radius back. Other gaskets available for other glass thicknesses

Cat. No.	Description	Finish	Glass Thickness	For Use	1	50	100	500	1000
EUZFBBN	Large D Shape Flat Back Glass Clamp	Brushed Nickel	-	Internally	£3.23	£2.94	£2.69	£2.39	£2.16
EUZFBCH	Large D Shape Flat Back Glass Clamp	Chrome	-	Internally	£3.28	£2.98	£2.73	£2.41	£2.18
EUZFBZ	Large D Shape Flat Back Glass Clamp	Raw Zinc	-	Internally	£2.64	£2.37	£2.20	£2.00	-
EUZFBMBL	Large D Shape Flat Back Glass Clamp	Matt Black	-	Internally	£2.74	£2.49	£2.28	£2.10	£1.96
EUZFBBS	Large D Shape Flat Back Glass Clamp	Brushed Stainless	-	Externally	£5.57	£5.16	£4.80	£4.50	-
EUZFBPS	Large D Shape Flat Back Glass Clamp	Polished Stainless	-	Externally	£7.41	£6.85	£6.38	£5.96	-
EUZ8G	Rubber Gaskets	-	8 mm	-	£0.25	£0.24	£0.23	£0.21	£0.20
EUZ10G	Rubber Gaskets	-	10 mm	-	£0.25	£0.24	£0.23	£0.21	£0.20

* Minimum order: 1. Price based on an order quantity of 1000 (EUZFBMBL).

CRL Square Type Flat Back Glass Clamps

- For use on mezzanines, partitions, railings and windbreaks
- For 6 to 10.76 mm glass
- Safety pin not included
- Size 45 x 45 x 27 mm
- Sold individually
- Matching flat rubber gaskets available, sold as a pair

~~WAS £1.70~~
NOW FROM ONLY
£1.56*
EACH



Also available in radius back. Other gaskets available for other glass thicknesses

Cat. No.	Description	Finish	Glass Thickness	For Use	1	50	100	500
EUZSFBBN	Square Type Flat Back Glass Clamp	Brushed Nickel	-	Internally	£2.87	£2.66	£2.48	£2.39
EUZSFZ	Square Type Flat Back Glass Clamp	Raw Zinc	-	Internally	£2.01	£1.84	£1.69	£1.56
EUZSFBS	Square Type Flat Back Glass Clamp	Brushed Stainless	-	Internally	£5.45	£4.85	£4.36	£4.19
EUZSFPS	Square Type Flat Back Glass Clamp	Polished Stainless	-	Internally	£6.64	£5.90	£5.30	£4.82
EUZS8G	Rubber Gaskets	-	8 mm	-	£0.27	£0.25	£0.23	£0.21
EUZS10G	Rubber Gaskets	-	10 mm	-	£0.27	£0.25	£0.23	£0.21

* Minimum order: 1. Price based on an order quantity of 500 (EUZSFZ).

CRL Large Square Type Flat Back Glass Clamps

- For use on mezzanines, partitions, railings and windbreaks
- For 6 to 12.76 mm toughened or laminated glass
- Safety pin included
- Side plates for use with laminated glass
- Size 55 x 55 x 35 mm
- Sold individually
- Matching flat rubber gaskets available, sold as a pair

~~WAS £2.82~~
NOW FROM ONLY
£2.50*
EACH



Also available in radius back. Other gaskets available for other glass thicknesses

Cat. No.	Description	Finish	Glass Thickness	For Use	1	50	100	500
EUZLSFBBSL	Large Square Type Flat Back Glass Clamp	Brushed Stainless	-	Externally	£12.12	£11.52	£10.24	£9.22
EUZLSFBZL	Large Square Type Flat Back Glass Clamp	Raw Zinc	-	Externally	£3.32	£2.96	£2.65	£2.50
EUZLS8GL	Rubber Gaskets	-	8 mm	-	£0.40	£0.37	£0.34	£0.30
EUZLS10GL	Rubber Gaskets	-	10 mm	-	£0.40	£0.37	£0.34	£0.30

* Minimum order: 1. Price based on an order quantity of 500 (EUZLSFBZL).