



ARCHITECTURAL GLASS FIXINGS

Systems for Glass Balustrades and Facades

Post Railings, TAPER-LOC® Frameless Glass Balustrade System, Juliette Balcony System, Frameless Windscreen Clamps, Heavy Duty Standoffs, Spider Fixings, and Glass Awning Support Systems.

GREENWICH PENINSULA





Contents

Post Railing System	04-13
Glass Clamps	14-23
TAPER-LOC® Frameless Glass Balustrade System	24-31
Cap Rails	32-33
Vinyl Inserts, Cements and Silicones	34-35
Juliette Balcony System	36-37
CRL Paris French Balcony System	38-39
Windscreen Clamps	40-41
Aluminium Railing System	42-61
Aluminium Windscreen System	62-77
Heavy Duty Standoffs	78-81
Al-Wall® Systems	82-83
Spider Fixings	84-99
Glass Awning Support System	100-109
Accessories	110-113

For more information call FREE on
00 800 0421 6144
f: 00 800 0262 3299

CRL Post Railing System



CRL Pre Assembled Post Railing System

Save time & money

In detail

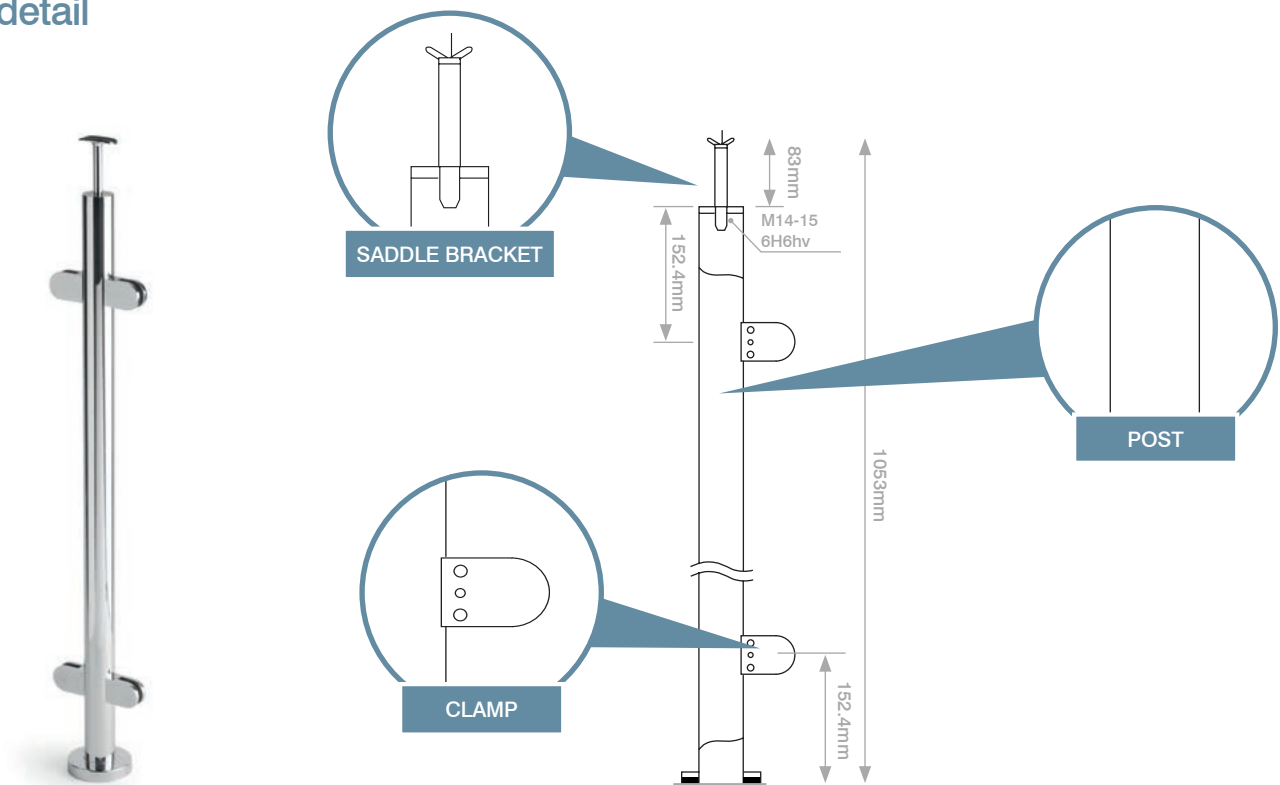

CAT. NO.

CAT. NO.



EUPR42BBS
Brushed
Stainless Steel



DESCRIPTION

1100mm Post

- 50.8mm post kits
- 316 grade stainless steel
- Sold as a complete post kit
- For 8.76mm, 10mm, 10.76mm and 12mm
- Available in brushed and polished stainless steel
- 1100mm high
- No clamps provided
- 2.5mm material thickness

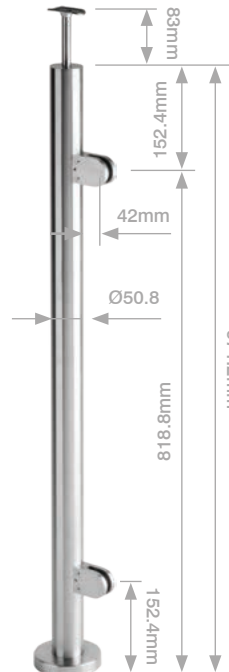
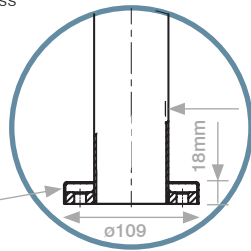

EUPR42EBS
Brushed
Stainless Steel



EUPR42EPS
Polished
Stainless steel

DESCRIPTION

1100mm End Post Kit

- 50.8mm post kits
- 316 grade stainless steel
- Sold as a complete post kit
- For 8.76mm, 10mm, 10.76mm and 12mm glass
- Available in brushed and polished stainless steel
- 2.5mm material thickness

CAT. NO.

CAT. NO.

CAT. NO.

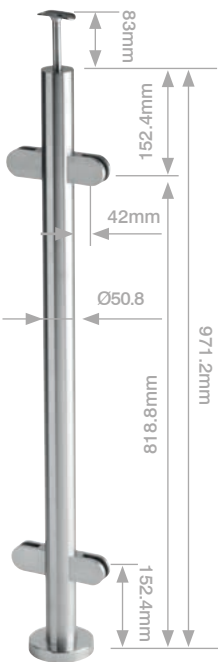

EUPR42CBS
Brushed
Stainless Steel

EUPR42CPS
Polished
Stainless Steel

DESCRIPTION

1100mm Centre Post Kit

- 50.8mm post kits
- 316 grade stainless steel
- Sold as a complete post kit
- For 8.76mm, 10mm, 10.76mm and 12mm glass
- Available in brushed and polished stainless steel
- 2.5mm material thickness

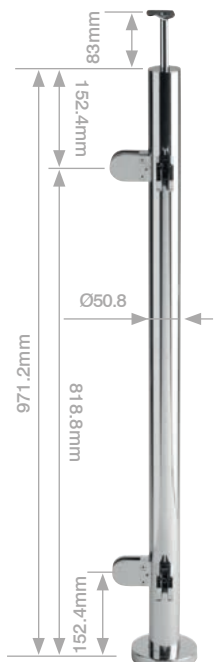

EUPR42LBS
Brushed
Stainless Steel

EUPR42LPS
Polished
Stainless Steel

DESCRIPTION

1100mm 90° Post Kit

- 50.8mm post kits
- 316 grade stainless steel
- Sold as a complete post kit
- For 8.76mm, 10mm, 10.76mm and 12mm glass
- Available in brushed and polished stainless steel
- 2.5mm material thickness

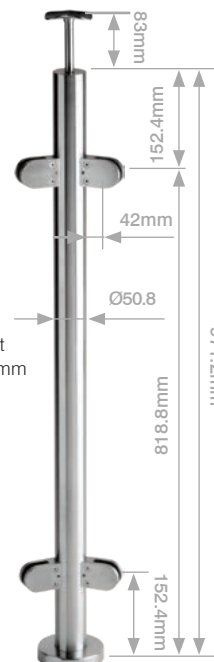

EUPR42ABS
Brushed
Stainless Steel

EUPR42APS
Polished
Stainless Steel

DESCRIPTION

1100mm 135° Post Kit

- 50.8mm post kits
- 316 grade stainless steel
- Sold as a complete post kit
- For 8.76mm, 10mm, 10.76mm and 12mm glass
- Available in brushed and polished stainless steel
- 2.5mm material thickness



CAT. NO.

DESCRIPTION

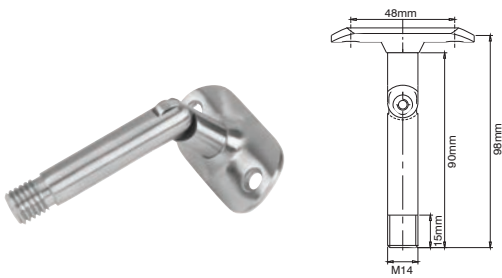

EUPR42ARBS

Brushed
Stainless Steel

EUPR42ARPS

Polished
Stainless Steel

110mm Post Angle Bracket

- For 50.8mm post kits
- Sold individually
- Used with European post kits
- 316 grade stainless steel
- Available in brushed and polished stainless steel

FOR 50.8MM KITS



EUPR42SBBS

Brushed
Stainless Steel

EUPR42SBPS

Polished
Stainless Steel

180° Saddle Bracket

- For 50.8mm post kits
- Sold individually
- Used with European post kits
- 316 grade stainless steel
- Available in brushed and polished stainless steel

FOR 50.8MM KITS

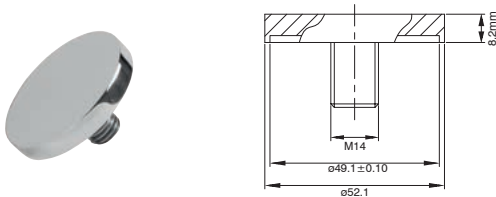

EUPR42CAPBS

Brushed
Stainless Steel

EUPR42CAPPS

Polished
Stainless Steel

110mm Post Flat Plate Cap

- For 50.8mm post kits
- Sold individually
- Used with European post kits
- 316 grade stainless steel
- Available in brushed and polished stainless steel

FOR 50.8MM KITS

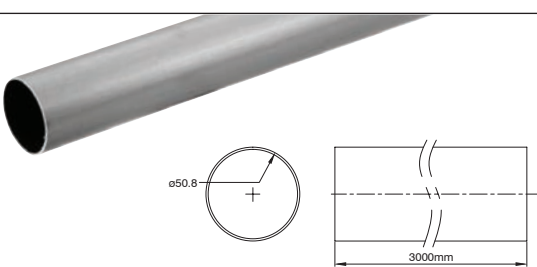

EUHR20BS

Brushed
Stainless Steel

EUHR20PS

Polished
Stainless Steel

3m Hand Rail Tubing

- For 50.8mm post kits
- Sold per 3 metre length
- Used with European post kits
- Two architectural finishes
- 1.2mm material thickness
- 316 grade stainless steel
- Available in brushed and polished stainless steel

FOR 50.8MM KITS

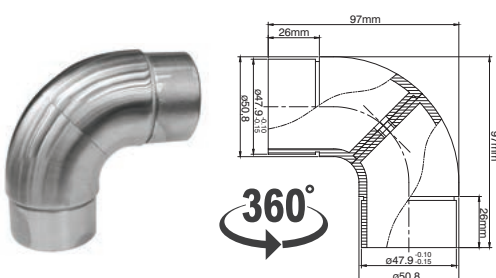

EUHR20PFBS

Brushed
Stainless Steel

EUHR20PFPS

Polished
Stainless Steel

360 Degree Swivel Fitting

- For 50.8mm post kits
- Used with handrail tubing
- 316 grade stainless steel
- Available in brushed and polished stainless steel

FOR 50.8MM KITS

50.8mm Diameter Hand Rail Components

Grade 316 Stainless steel

	CAT. NO.	DESCRIPTION
	<p>EUHR20ECBS Brushed Stainless Steel</p> <p>EUHR20ECPS Polished Stainless Steel</p> <p>FOR 50.8MM KITS</p>	<p>End Cap</p> <ul style="list-style-type: none"> • For 50.8mm post kits • Sold individually • Used with handrail tubing • 316 grade stainless steel
	<p>EUHR20SECBS Brushed Stainless Steel</p> <p>EUHR20SECPS Polished Stainless Steel</p> <p>FOR 50.8MM KITS</p>	<p>Securing End Cap</p> <ul style="list-style-type: none"> • For 50.8mm post kits • Sold individually • Used with handrail tubing • 316 grade stainless steel
	<p>EUHR20YBS Brushed Stainless Steel</p> <p>EUHR20YPS Polished Stainless Steel</p> <p>FOR 50.8MM KITS</p>	<p>CRL Full Flange</p> <ul style="list-style-type: none"> • For 50.8mm Tubing • 316 grade stainless steel
	<p>EUHR20CSS</p> <p>FOR 50.8MM KITS</p>	<p>Internal Connector</p> <ul style="list-style-type: none"> • For 50.8mm post kits • Used with handrail tubing • 316 grade stainless steel
	<p>EUHR20HBS Brushed Stainless Steel</p> <p>EUHR20HPS Polished Stainless Steel</p> <p>FOR 50.8MM KITS</p>	<p>90° Corner</p> <ul style="list-style-type: none"> • For 50.8mm post kits • Sold individually • Used with European post kits • 316 grade stainless steel
	<p>EUHR20H3BS Brushed Stainless Steel</p> <p>EUHR20H3PS Polished Stainless Steel</p> <p>FOR 50.8MM KITS</p>	<p>135° Corner</p> <ul style="list-style-type: none"> • Sold individually • Used with handrail tubing • 316 grade stainless steel
	<p>EUHR20ADJBS Brushed Stainless Steel</p> <p>EUHR20ADJPS Polished Stainless Steel</p> <p>FOR 50.8MM KITS</p>	<p>Adjustable Handrail Fitting</p> <ul style="list-style-type: none"> • For 50.8mm post kits • Sold individually • Used with handrail tubing • 316 grade stainless steel

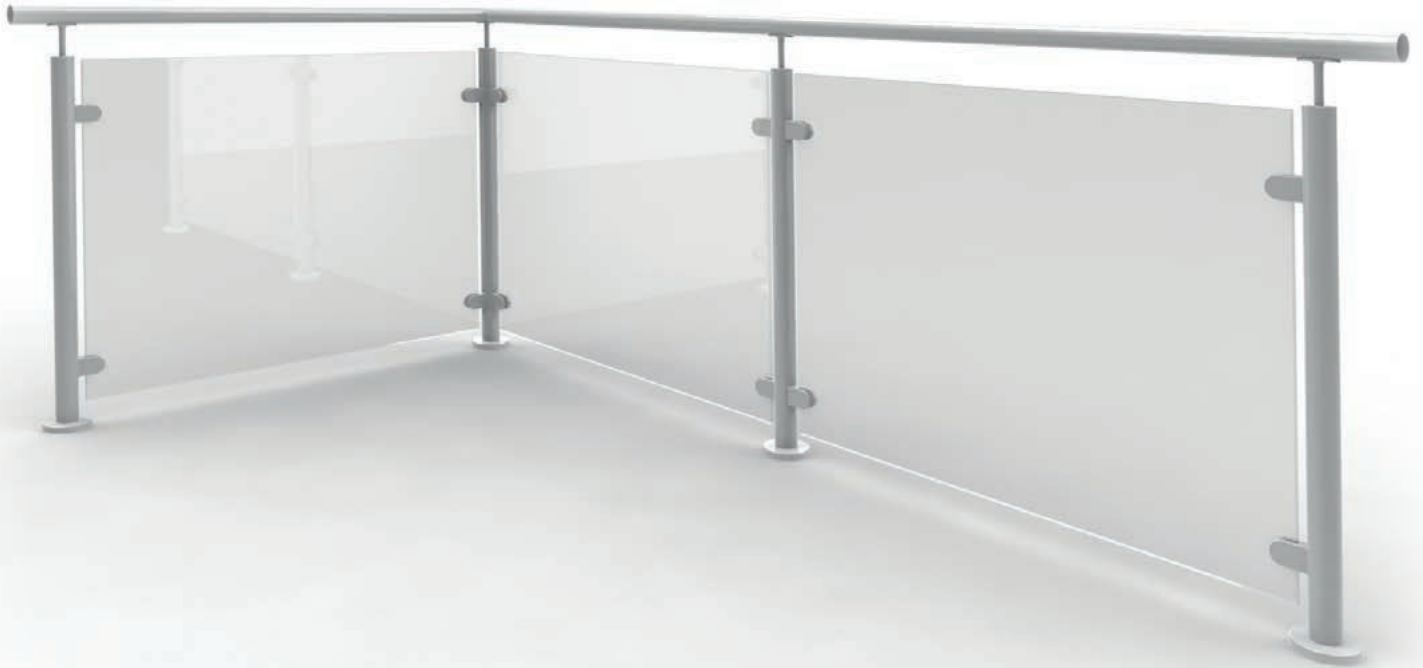

42.4mm Post Kits

CAT. NO.

EUPR4242BBS

Brushed
Stainless Steel

EUPR4242BPS

Polished
Stainless Steel



DESCRIPTION

1100mm Post

- 42.4mm posts
- 316 grade stainless steel
- Sold as a complete post kit
- For 8.76mm, 10mm, 10.76mm and 12mm glass
- Available in brushed and polished stainless steel
- 1100mm high
- No clamps provided
- 2.5mm material thickness

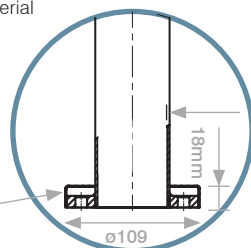

Stainless
steel
cover

CAT. NO.

EUPR4242CBS

Brushed
Stainless Steel

EUPR4242CPS

Polished
Stainless Steel



DESCRIPTION

1100mm Centre Post Kit

- 42.4mm posts
- 316 grade stainless steel
- Sold as a complete post kit
- For 8.76mm, 10mm, 10.76mm and 12mm glass
- Available in brushed and polished stainless steel
- 2.5mm material thickness

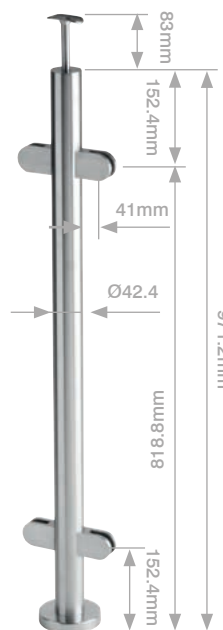

CAT. NO.

EUPR4242EBS
Brushed Stainless Steel

EUPR4242EPS
Polished Stainless Steel

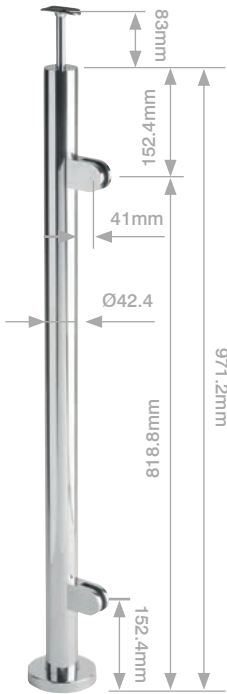

DESCRIPTION

1100mm End Post Kit

- 42.4mm posts
- 316 grade stainless steel
- Sold as a complete post kit
- For 8.76mm, 10mm, 10.76mm and 12mm glass
- Available in brushed and polished stainless steel
- 2.5mm material thickness

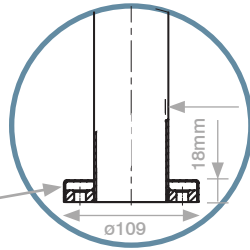

CAT. NO.

EUPR4242LBS
Brushed Stainless Steel

EUPR4242LPS
Polished Stainless Steel

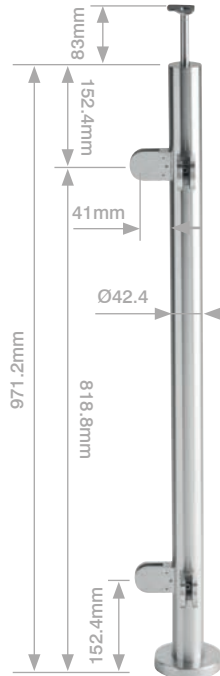

DESCRIPTION

1100mm 90° Post Kit

- 42.4mm posts
- 316 grade stainless steel
- Sold as a complete post kit
- For 8.76mm, 10mm, 10.76mm and 12mm glass
- Available in brushed and polished stainless steel
- 2.5mm material thickness

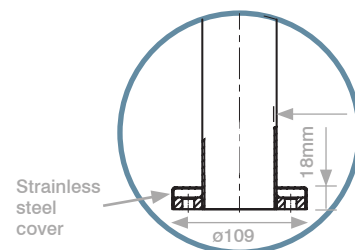

CAT. NO.

EUPR42ARBS
Brushed
Stainless Steel

EUPR42ARPS
Polished
Stainless Steel

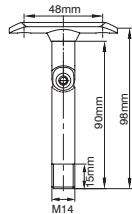

DESCRIPTION

1100mm Post Angle Bracket

FOR 42.4MM KITS

- For 42.4mm posts
- Used with European post kits
- 316 grade stainless steel

EUPR42SBBS
Brushed
Stainless Steel

EUPR42SBPS
Polished
Stainless Steel

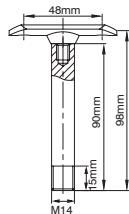

Saddle Bracket 180° Fixed

FOR 42.4MM KITS

- For 42.4mm posts
- Used with European post kits
- 316 grade stainless steel

EUPR4242CAPBS
Brushed
Stainless Steel

EUPR4242CAPPS
Polished
Stainless Steel

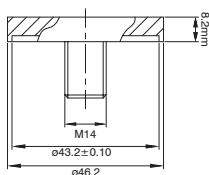

1100mm Post Flat Plate Cap

FOR 42.4MM KITS

- For 42.4mm posts
- Used with European post kits
- 316 grade stainless steel

CRL Post Railing System





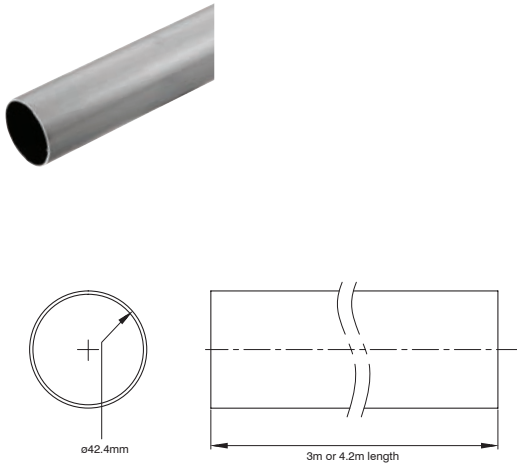
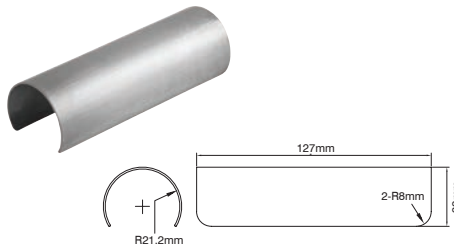
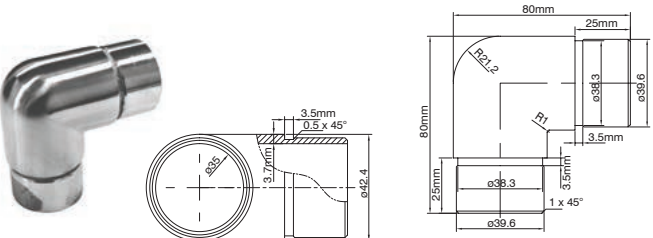
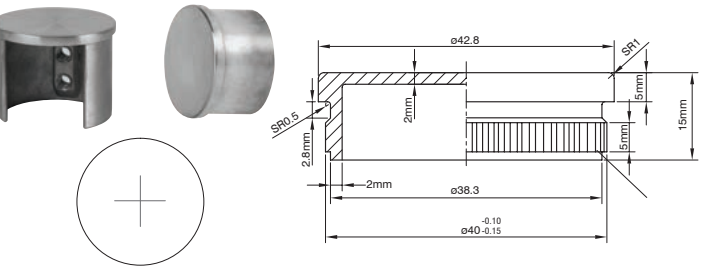
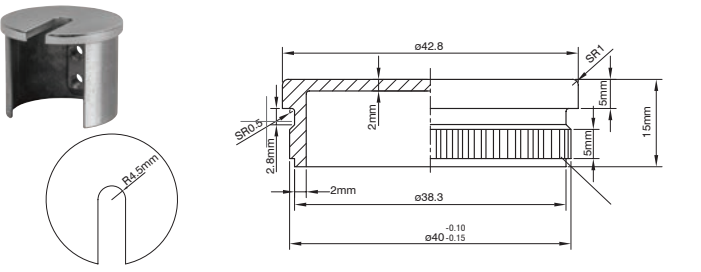



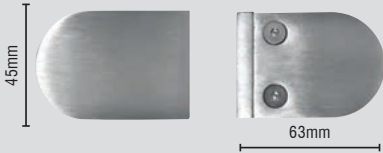

42.4mm Diameter Hand Rail Components

Grade 316 Stainless steel

	CAT. NO.	DESCRIPTION
	<p>EUHR42BS Brushed Stainless Steel - 3m</p> <p>EUHR42PS Polished Stainless Steel - 3m</p> <p>EUHR42BS14 Brushed Stainless Steel - 4.2m</p> <p>EUHR42PS14 Polished Stainless Steel - 4.2m</p> <p>FOR 42.4MM KITS</p>	<p>Handrail</p> <ul style="list-style-type: none"> • 42.4mm handrails • Available in 3m or 4.2m lengths • 42.4mm x 1.2mm
	<p>EUHR42CSS Brushed Stainless Steel</p> <p>FOR 42.4MM KITS</p>	<p>Int Connector</p> <ul style="list-style-type: none"> • For 42.4mm handrails • 127mm Length • Grade 316 Stainless Steel
	<p>EUHR42HBS Brushed Stainless Steel</p> <p>EUHR42HPS Polished Stainless Steel</p> <p>FOR 42.4MM KITS</p>	<p>90° Corner</p> <ul style="list-style-type: none"> • For 42.4mm handrail tubing • Grade 316 Stainless Steel
	<p>EUHR42ECBS Brushed Stainless Steel</p> <p>EUHR42ECPS Polished Stainless Steel</p> <p>FOR 42.4MM KITS</p>	<p>End Cap</p> <ul style="list-style-type: none"> • For 42.4mm post kits • Used with 42.4mm handrail • 316 grade stainless steel
	<p>EUHR42SECBS Brushed Stainless Steel</p> <p>EUHR42SECPS Polished Stainless Steel</p> <p>FOR 42.4MM KITS</p>	<p>Securing End Cap</p> <ul style="list-style-type: none"> • For 42.4mm post kits • Used with 42.4mm handrail • 316 grade stainless steel

Ideal Clamps for pre-assembled postkits

Grade 316 Stainless steel

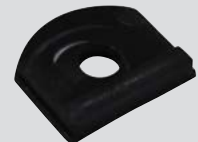
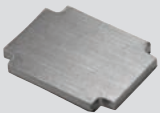
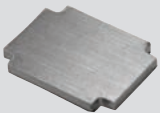
		CAT. NO.	DESCRIPTION
		EUZ51012BS Brushed Stainless Steel	Flat Back Clamp for use with 50.8mm Diameter Posts <ul style="list-style-type: none"> • For use on mezzanines, partitions, railings and windbreaks • 316 grade stainless steel • For 10 and 12mm glass • Comes complete with gaskets for monolithic toughened glass • Sold Individually
		EUZ51012PS Polished Stainless Steel	
			Radius Back Clamp for use with 50.8mm Diameter Posts <ul style="list-style-type: none"> • Radius back for use with 50.8mm diameter posts • For use on mezzanines, partitions, railings and windbreaks • 316 grade stainless steel • For 10 and 12mm glass • Comes complete with gaskets for monolithic toughened glass • Sold Individually
			
			Gasket For EUZ5 Clamps <ul style="list-style-type: none"> • Gaskets to be Used with EUZ51012 Clamps • Suitable for laminated glass (tempered laminated)
	EUZ5GASK107 For 10.7mm Glass EUZ5GASK87 For 8.7mm Glass		
		EUZ5SUPPORT	Support Plate For EUZ5 Clamps <ul style="list-style-type: none"> • Bottom supporting plate to be used with EUZ51012 clamps • Suitable when laminated glass (tempered laminated) is installed • This supporting plate prevents the clamp from applying too much pressure on the surfaces of the glass



The range of clamps shown here are ideal for our range of pre-assembled post kits. For alternative clamp options, please see pages 14 - 23

CRL Post Railing System



Grade 316 Stainless steel

CRL also offers a full range of components for custom post railing systems

CRL Custom Post Components 48.3mm - Fabrication Required

	CAT. NO.	DESCRIPTION
	<p>EUHR4825BS Brushed Stainless Steel</p> <p>EUHR4825PS Polished Stainless Steel</p>	<p>3600mm Brushed Stainless Steel Tubing</p> <ul style="list-style-type: none"> • 48.3mm diameter • 316 Grade stainless steel • 2.5mm material thickness • Post and Handrail
	<p>EUHR4825MCBS Brushed Stainless Steel</p> <p>EUHR4825MCPS Polished Stainless Steel</p>	<p>90° Mitred Corner</p> <ul style="list-style-type: none"> • 48.3mm diameter • 316 Grade stainless steel
	<p>EUHR4825SBS Brushed Stainless Steel</p> <p>EUHR4825SPS Polished Stainless Steel</p>	<p>180° Post Mount Fixed Saddle</p> <ul style="list-style-type: none"> • 48.3mm diameter • 316 Grade stainless steel
	<p>EUHR4825SHBS Brushed Stainless Steel</p> <p>EUHR4825SHPS Polished Stainless Steel</p>	<p>90° Mount Fixed Saddle</p> <ul style="list-style-type: none"> • 48.3mm • 316 Grade stainless steel



Grade 316 Stainless steel

	CAT. NO.	DESCRIPTION
	<p>EUHR4825ASBS Brushed Stainless Steel</p> <p>EUHR4825ASPS Polished Stainless Steel</p>	<p>180° Mount Adjustable Saddle</p> <ul style="list-style-type: none"> • To suit 48.3mm diameter tubing • 316 Grade stainless steel
	<p>EUHR4825XCBS Brushed Stainless Steel</p> <p>EUHR4825XCPS Polished Stainless Steel</p>	<p>Flange & Canopy Kit</p> <ul style="list-style-type: none"> • To suit 48.3mm diameter tubing • 316 Grade stainless steel
	<p>EUHR4825XBS Brushed Stainless Steel</p> <p>EUHR4825XPS Polished Stainless Steel</p>	<p>Flange / Canopy / Tube</p> <ul style="list-style-type: none"> • To suit 48.3mm diameter tubing • 316 Grade stainless steel
	<p>EUHR4825FBBS Brushed Stainless Steel</p> <p>EUHR4825FBPS Polished Stainless Steel</p>	<p>Fascia Bracket</p> <ul style="list-style-type: none"> • To suit 48.3mm diameter tubing • 316 Grade stainless steel
	<p>EUHR4825ECBS Brushed Stainless Steel</p> <p>EUHR4825ECPS Polished Stainless Steel</p>	<p>End Caps</p> <ul style="list-style-type: none"> • To suit 48.3mm diameter tubing • 316 Grade Brushed Stainless Steel

CAT. NO.

DESCRIPTION

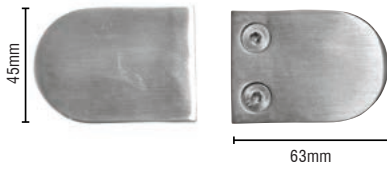

EUZ42RBN
Brushed Nickel
Zinc Body

EUZ42RBS
Brushed 316
Stainless Steel

EUZ42RPS
Polished 316
Stainless Steel

CRL Large D Shape 42.4mm Radius Back Clamp

- Radius back for use with 42.4mm diameter posts
- For use on mezzanines, partitions, railings and windbreaks
- Steel pin included for additional glass support
- For 8 to 12.76mm toughened or laminated glass
- Sold individually
- Rubber Gasket not included
- Please order the following rubber gaskets to suit:

CAT.NO. EUZ8G for 8mm glass
CAT.NO. EUZ876G for 8.76mm glass
CAT.NO. EUZ10G for 10mm glass
CAT.NO. EUZ1076G for 10.76mm glass
CAT.NO. EUZ12G for 12mm glass
CAT.NO. EUZ1276G for 12.76mm glass

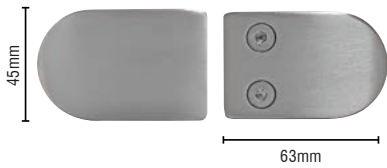
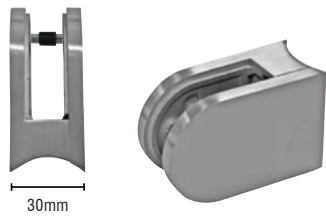

EUZ48RBN
Brushed Nickel
Zinc Body

EUZ48RBS
Brushed 316
Stainless Steel

EUZ48RPS
Polished 316
Stainless Steel

CRL Large D Shape 48.3mm Radius Back Clamp

- Radius back for use with 48.3mm diameter posts
- For use on mezzanines, partitions, railings and windbreaks
- Steel pin included for additional glass support
- For 8 to 12.76mm toughened or laminated glass
- Sold individually
- Rubber Gasket not included
- Please order the following rubber gaskets to suit:

CAT.NO. EUZ8G for 8mm glass
CAT.NO. EUZ876G for 8.76mm glass
CAT.NO. EUZ10G for 10mm glass
CAT.NO. EUZ1076G for 10.76mm glass
CAT.NO. EUZ12G for 12mm glass
CAT.NO. EUZ1276G for 12.76mm glass

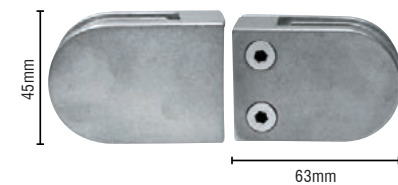
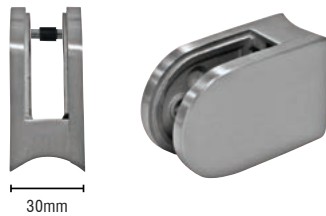

EUZFBZ
Raw Zinc Finish

EUZFBBS
Brushed 316
Stainless Steel

EUZFBPS
Polished 316
Stainless Steel

EUZFBBN
Brushed Nickel

CRL Large D Shape Flat Back Clamp

- For use on mezzanines, partitions, railings and windbreaks
- Steel pin included for additional glass support
- For 8 to 12.76mm toughened or laminated glass
- Sold individually
- Rubber gasket not included
- Please order the following rubber gaskets to suit:

CAT.NO. EUZ8G for 8mm glass
CAT.NO. EUZ876G for 8.76mm glass
CAT.NO. EUZ10G for 10mm glass
CAT.NO. EUZ1076G for 10.76mm glass
CAT.NO. EUZ12G for 12mm glass
CAT.NO. EUZ1276G for 12.76mm glass

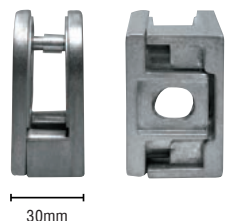

Grade 316 Stainless steel

	CAT. NO.	DESCRIPTION
	<p>EUZSFBBP Brushed 316 Stainless Steel</p> <p>EUZSFBBN Brushed Nickel</p>	<p>CRL Square Type Back Clamp</p> <ul style="list-style-type: none"> • For use on mezzanines, partitions, railings and windbreaks • For 6 to 10.76mm toughened or laminated glass • Sold individually • Rubber gasket not included • Please order the following rubber gaskets to suit: <ul style="list-style-type: none"> CAT.NO. EUZS6G for 6mm glass CAT.NO. EUZS8G for 8mm glass CAT.NO. EUZS876G for 8.76mm glass CAT.NO. EUZS10G for 10mm glass CAT.NO. EUZS1076G for 10.76mm glass • Pin not included
	<p>EUZSFBBSL Brushed 316 Stainless Steel</p> <p>EUZSFBBZL Zinc Body</p>	<p>CRL Square Type Back Clamp</p> <ul style="list-style-type: none"> • For use on mezzanines, partitions, railings and windbreaks • For 6 to 12.76mm toughened or laminated glass • Sold individually • Removable pin • Rubber gasket not included • Please order the following rubber gaskets to suit: <ul style="list-style-type: none"> CAT.NO. EUZS6GL for 6mm glass CAT.NO. EUZS676GL for 6.76mm glass CAT.NO. EUZS8GL for 8mm glass CAT.NO. EUZS876GL for 8.76mm glass CAT.NO. EUZS10GL for 10mm glass CAT.NO. EUZS1076GL for 10.76mm glass CAT.NO. EUZS12GL for 12mm glass CAT.NO. EUZS1276GL for 12.76mm glass
	<p>EUZLSFBBSL Brushed 316 Stainless Steel</p> <p>EUZLSFBZL Zinc Body</p>	<p>CRL Square Type Flat Back Clamp</p> <ul style="list-style-type: none"> • For use on mezzanines, partitions, railings and windbreaks • Side plates for use with laminated glass • For 6 to 12.76mm toughened or laminated glass • Safety pin included • Sold individually • Rubber gasket not included • Supplied with support plate • Please order the following rubber gaskets to suit: <ul style="list-style-type: none"> CAT.NO. EUZLS6GL for 6mm glass CAT.NO. EUZLS676GL for 6.76mm glass CAT.NO. EUZLS8GL for 8mm glass CAT.NO. EUZLS876GL for 8.76mm glass CAT.NO. EUZLS10GL for 10mm glass CAT.NO. EUZLS1076GL for 10.76mm glass CAT.NO. EUZLS12GL for 12mm glass CAT.NO. EUZLS1276GL for 12.76mm glass



CAT. NO.

DESCRIPTION

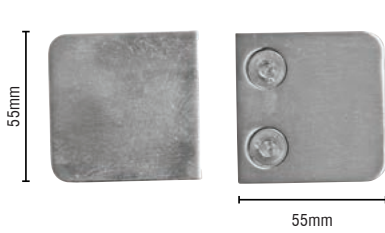

EUZLS42RBSL
Brushed 316
Stainless Steel
EUZLS42RZL
Zinc

CRL Square Type 42.4mm Radius Back Clamp

- Radius back for use with 42.4mm diameter posts
- For use on mezzanines, partitions, railings and windbreaks
- Side plates for use with laminated glass included
- For 6 to 12.76mm toughened or laminated glass
- Safety pin included
- Sold individually
- Please order the following rubber gaskets to suit:
CAT.NO. EUZLS6GL for 6mm glass
CAT.NO. EUZLS676GL for 6.76mm glass
CAT.NO. EUZLS8GL for 8mm glass
CAT.NO. EUZLS876GL for 8.76mm glass
CAT.NO. EUZLS10GL for 10mm glass
CAT.NO. EUZLS1076GL for 10.76mm glass
CAT.NO. EUZLS12GL for 12mm glass
CAT.NO. EUZLS1276GL for 12.76mm glass

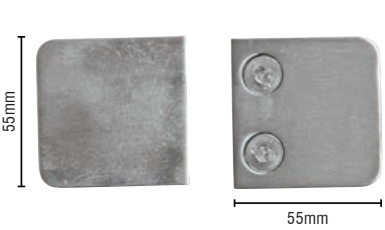
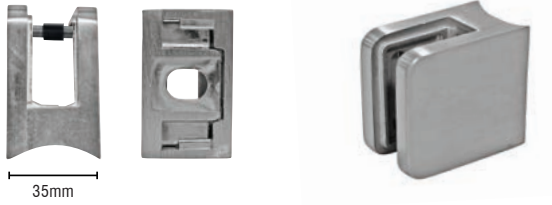



EUZLS48RBSL
Brushed
Stainless Steel
EUZLS48RZL
Zinc

CRL Square Type 48.3mm Radius Back Clamp

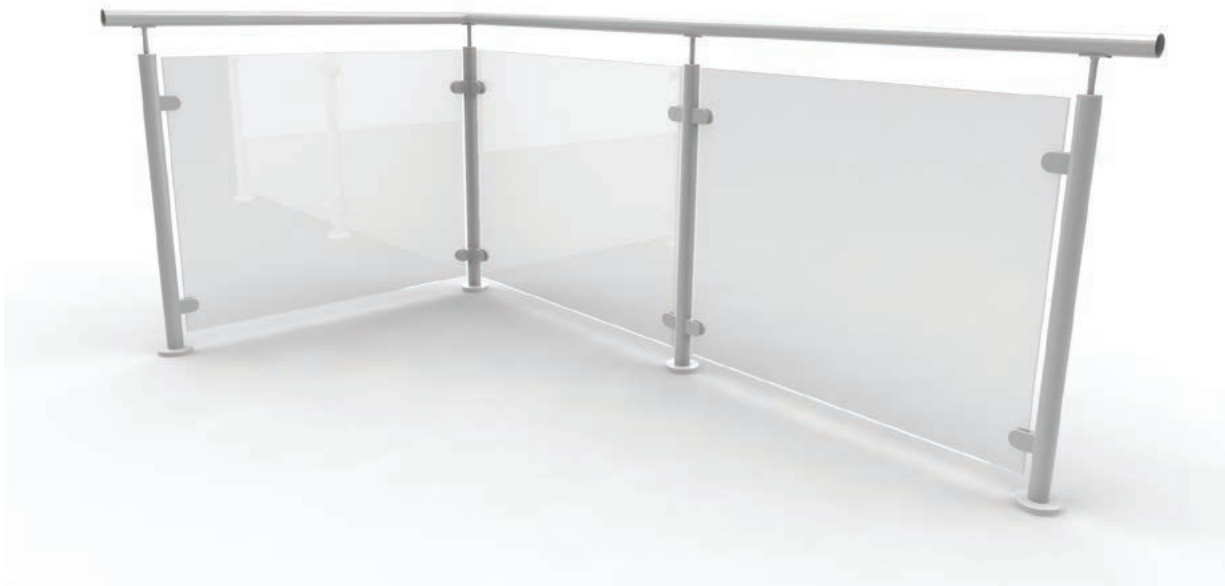
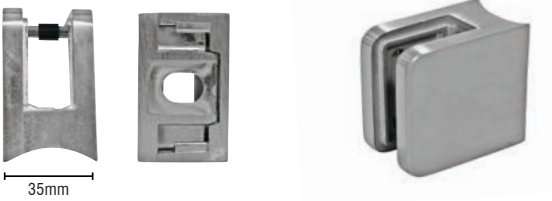
- Radius back for use with 48.3mm diameter posts
- For use on mezzanines, partitions, railings and windbreaks
- Side plates for use with laminated glass included
- For 6 to 12.76mm toughened or laminated glass
- Safety pin included
- Sold individually
- Rubber gasket not included
- Please order the following rubber gaskets to suit:
CAT.NO. EUZLS6GL for 6mm glass
CAT.NO. EUZLS676GL for 6.76mm glass
CAT.NO. EUZLS8GL for 8mm glass
CAT.NO. EUZLS876GL for 8.76mm glass
CAT.NO. EUZLS10GL for 10mm glass
CAT.NO. EUZLS1076GL for 10.76mm glass
CAT.NO. EUZLS12GL for 12mm glass
CAT.NO. EUZLS1276GL for 12.76mm glass



CAT. NO.	DESCRIPTION
	<p>EUZ8G For 8mm Glass</p> <p>EUZ876G For 8.76mm Glass</p> <p>EUZ10G For 10mm Glass</p> <p>EUZ1076G For 10.76mm Glass</p> <p>EUZ12G For 12mm Glass</p> <p>EUZ1276G For 10.76mm Glass</p> <p>CRL Rubber gasket for EUZFB/EUZ42/EUZ48 Series Clamps</p> <ul style="list-style-type: none"> • 63mm x 45mm • For use with toughened or laminated glass • Sold by the pair • Black colour
	<p>EUZS8G For 8mm Glass</p> <p>EUZS876G For 8.76mm Glass</p> <p>EUZS10G For 10mm Glass</p> <p>EUZS1076G For 10.76mm Glass</p> <p>CRL Rubber gasket for EUZSF Series Clamps</p> <ul style="list-style-type: none"> • 45mm x 45mm • For use with toughened or laminated glass • Sold by the pair • Black colour
	<p>EUZLS6GL For 6mm Glass</p> <p>EUZLS676GL For 6.76mm Glass</p> <p>EUZLS8GL For 8mm Glass</p> <p>EUZLS876GL For 8.76mm Glass</p> <p>EUZLS10GL For 10mm Glass</p> <p>EUZLS1076GL For 10.76mm Glass</p> <p>EUZLS12GL For 12mm Glass</p> <p>EUZLS1276GL For 12.76mm Glass</p> <p>CRL Rubber gasket for EUZLSF/EUZLS42/EUZLS48 Series Clamps</p> <ul style="list-style-type: none"> • 55mm x 55mm • For use with toughened or laminated glass • Sold by the pair • Black colour



Glass Clamps

Grade 316 Stainless steel

Round

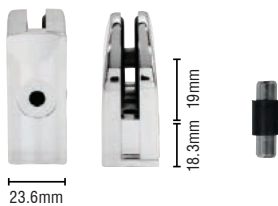
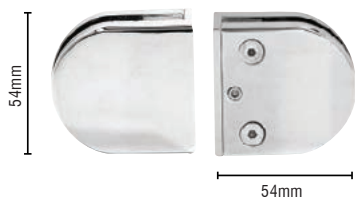

CAT. NO.

Z406CH

Chrome

Z406BN

Brushed Nickel

Z406BR

Brass

Z406GP

Gold

Z406SC

Satin Chrome

Z406W

White

DESCRIPTION

CRL Z-Series Round Type Flat Base Zinc Clamp

- 6mm and 8mm glass
- Replacement gaskets are available by ordering CRL Cat. No. Z14RG
- The ideal clamp for use on mezzanines, partitions, railings and windbreaks
- Base metal: zinc casting
- Steel pin included for optional use
- Tested and engineered to meet and exceed code standards
- Removable securing pin provided with clamp



CAT. NO.

DESCRIPTION



- Z410CH**
Chrome
- Z410BN**
Brushed Nickel
- Z410BR**
Brass
- Z410GP**
Gold
- Z410SC**
Satin Chrome
- Z410W**
White

CRL Z-Series Round Type Flat Base Zinc Clamp

- 10mm glass
- Replacement gaskets are available by ordering CRL Cat. No. Z38RG
- The ideal clamp for use on mezzanines, partitions, railings and windbreaks
- Base metal: zinc casting
- Steel pin available for additional glass support
- Tested and engineered to meet and exceed code standards

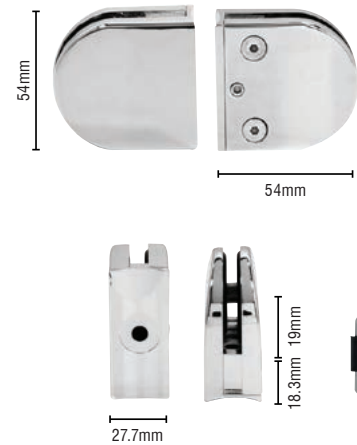

- Z210CH**
Chrome
- Z410BN**
Brushed Nickel
- Z210BR**
Brass
- Z210GP**
Gold
- Z210SC**
Satin Chrome
- Z210W**
White

CRL Z-Series Round Type 50.8mm Radius Base Zinc Clamp

- For 10mm thick glass
- The ideal clamp for use on mezzanines, partitions, railings and windbreaks
- Base metal: zinc casting
- Steel pin included for optional use
- Tested and engineered to meet and exceed code standards
- Removable securing pin provided with clamp
- Replacement gaskets available

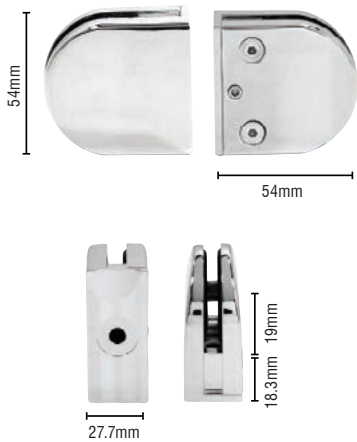

- Z510PS**
Polished Stainless
- Z510BS**
Brushed Stainless
- Z510PT**
Painted

CRL Z-Series Round Type Flat Base Stainless Steel Clamp

- For 10mm glass
- Replacement gaskets are available by ordering CRL Cat. No. Z38RG
- The ideal clamp for use on mezzanines, partitions, railings and windbreaks
- Base metal: stainless steel
- Steel pin included for optional use
- Tested and engineered to meet and exceed code standards
- Removable securing pin provided with clamp
- Z510PS is Grade 316



CRL Glass Hardware

CAT. NO.

DESCRIPTION



Z310PS
Polished Stainless

Z310BS
Brushed Stainless

CRL Z-Series Round Type 50.8mm Radius Base Stainless Steel Clamp

- For 10mm glass
- The ideal clamp for use on mezzanines, partitions, railings and windbreaks
- Base metal: stainless steel
- Steel pin included for optional use
- Tested and engineered to meet and exceed code standards
- Removable securing pin provided with clamp

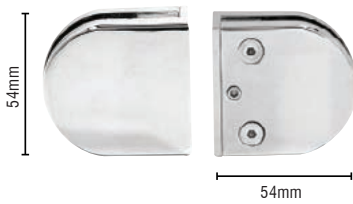
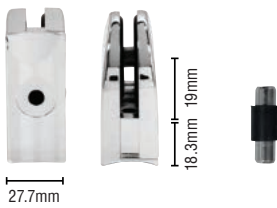

Z412CH
Chrome

Z412BN
Brushed Nickel

Z412BR
Brass

Z412GP
Gold

Z412SC
Satin Chrome

Z412W
White

CRL Z-Series Round Type Flat Base Zinc Clamp

- 12mm glass
- Replacement gaskets are available by ordering CRL Cat. No. Z12RG
- The ideal clamp for use on mezzanines, partitions, railings and windbreaks
- Base metal: zinc casting
- Steel pin included for optional use
- Tested and engineered to meet and exceed code standards (engineering reports)
- Removable securing pin provided with clamp

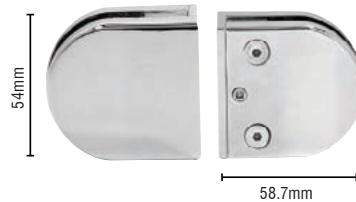
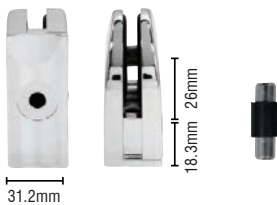

Z512PS
Polished Stainless

Z512BS
Brushed Stainless

Z512PT
Painted

CRL Z-Series Round Type Flat Base Stainless Steel Clamp

- For 12mm glass
- Replacement gaskets are available by ordering CRL Cat. No. Z12RG
- The ideal clamp for use on mezzanines, partitions, railings and windbreaks
- Base metal: stainless steel
- Steel pin included for optional use
- Tested and engineered to meet and exceed code standards
- Removable securing pin provided with clamp

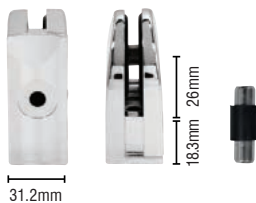

Square

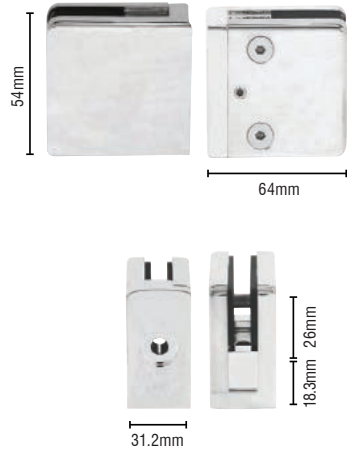

CAT. NO.

- Z812BN**
Chrome
- Z812BN**
Brushed Nickel
- Z812BR**
Brass
- Z812GP**
Gold
- Z812SC**
Satin Chrome
- Z812W**
White

DESCRIPTION

CRL Z-Series Square Type Flat Base Zinc Clamp

- Designed to accommodate 12mm glass thickness
- Replacement gaskets are available by ordering CRL Cat. No. Z12SG
- The ideal clamp for use on mezzanines, partitions, railings and windbreaks
- Steel pin included for optional use
- Tested and engineered to meet and exceed code standards
- Removable securing pin provided with clamp

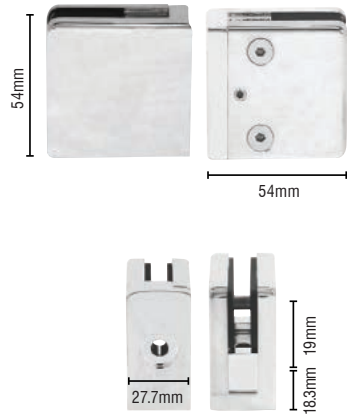



- Z810CH**
Chrome
- Z810BN**
Brushed Nickel
- Z810SC**
Satin Chrome
- Z810BR**
Brass
- Z810GP**
Gold
- Z810W**
White

CRL Z-Series Square Type Flat Base Zinc Clamp

- Designed to accommodate glass thickness of 10mm
- The ideal clamp for use on mezzanines, partitions, railings and windbreaks
- Base metal: zinc casting
- Steel pin included for optional use
- Tested and engineered to meet and exceed code standards
- Removable securing pin provided with clamp



	CAT. NO.	DESCRIPTION
	<p>Z610CH Chrome</p> <p>Z610BN Brushed Nickel</p> <p>Z610BR Brass</p> <p>Z610GP Gold</p> <p>Z610SC Satin Chrome</p> <p>Z610W White</p>	<p>CRL Z-Series Square Type Radius Base Zinc Clamp</p> <ul style="list-style-type: none"> • For 10mm glass • Replacement gaskets are available by ordering CRL Cat. No. Z38SG • The ideal clamp for use on mezzanines, partitions, railings and windbreaks • Base metal: zinc casting • Steel pin included for optional use • Tested and engineered to meet and exceed code standards • Removable securing pin provided with clamp 
	<p>Z910PS Polished Stainless</p> <p>Z910BS Brushed Stainless</p> <p>Z910MBL Matte Black</p> <p>Z910PT Painted</p>	<p>CRL Z-Series Square Type Flat Base Stainless Steel Clamp</p> <ul style="list-style-type: none"> • Designed to accommodate glass thickness of 10mm • Replacement gaskets are available by ordering CRL Cat. No. Z38SG • The ideal clamp for use on mezzanines, partitions, railings and windbreaks • Steel pin included for optional use • Tested and engineered to meet and exceed code standards • Removable securing pin provided with clamp • Grade 316 
	<p>Z710PS Polished Stainless</p> <p>Z710BS Brushed Stainless</p> <p>Z710MBL Matte Black</p> <p>Z710PT Painted</p>	<p>CRL Z-Series Square Type Radius Base Stainless Steel Clamp</p> <ul style="list-style-type: none"> • For 10mm glass • Replacement gaskets are available by ordering CRL Cat. No. Z38SG • The ideal clamp for use on mezzanines, partitions, railings and windbreaks • Base metal: stainless steel • Steel pin included for optional use • Tested and engineered to meet and exceed code standards (engineering reports) • Removable securing pin provided with clamp • Grade 316 

CAT. NO.**DESCRIPTION**

Z934BS
Brushed Stainless

Z934PS
Polished Stainless

Z934MBL
Matte Black

CRL Brushed Stainless Z-Series Flat Surface Mount Square Type Glass Clamps

- For 19 mm glass (flat surface mounting)
- For use with square tubing or other flat surfaces
- 316 Alloy stainless steel
- Use monolithic tempered glass

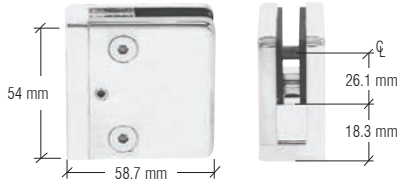

Z734BS
Brushed Stainless

Z734PS
Polished Stainless

Z34PT
Painted

CRL Brushed Stainless Z-Series Radius Surface Mount Square Type Glass Clamps

- For 19mm glass (radius surface mounting)
- For use with 50.8 mm diameter round tubing
- 316 Alloy stainless steel
- Use monolithic tempered glass

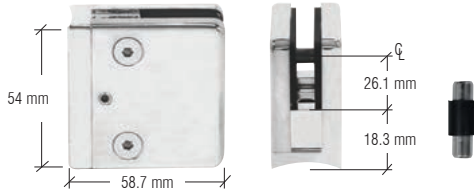

ZBOLT
8mm
25.4mm length

CRL Z-Clamp Bolt

- For securing Z-Series clamps to tubing
- Simplifies Z-Clamp installation
- For metal attachments
- Minimum order quantity 10



ZLAG
8mm diameter
51mm length
5/16" thread

CRL Z-Clamp Lag Bolt

- Stainless screws for use with CRL's Z-Series clamps
- Simplifies Z-Clamp installation
- For wood attachments
- Minimum order quantity 10



155618
5/16"-18NC

CRL Fractional Size Tap

- Five sizes available
- High-carbon steel



D4120
2mm diameter
49mm length

CRL Metric Sized Jobber's Length Drill Bit

- Fast starting 118 degree point tip
- Straight shank
- Black oxide finish
- Other sizes available



Install glass balustrades with ease...

Conforming to Building Standards Across Europe

At CRL, we are committed to the testing and development of all of our products. All CRL TAPER-LOC® Systems are independently tested to meet British, German, French and US Standards. We have solutions up to and including 3kN load tests.

SIMPLE. FAST. SAFE.

FRAMELESS GLASS BALUSTRADE SYSTEM

- Dry-glazed installation - TAPER-LOC[®] facilitates the fastest possible way to install glass balustrades and is clean for the installer and the finished product
- Saves Time & Money while maximising safe working conditions - The horizontal TAPER-LOC[®] design allows the system to be adjusted, dismantled and re-set completely from the 'safe side' of the balustrade (including both 'fast-seal gaskets'), avoiding scaffolding cost and time (particularly useful in retrospective fit and when changing a glass panel)
- Designed and tested for use with 17.52, 21.52 and 25.52 mm toughened laminated glass and 12, 15 and 19 mm toughened monolithic glass
- Surface (D) and fascia (F) drilled base shoe available
- Enables the strongest and safest barriers, giving the installer and the final user peace of mind

**INNOVATIVE
 EXTRUDED
 STRUCTURE**



**CAN BE
 COMPLETELY
 INSTALLED
 FROM THE
 'SAFE SIDE'**

Step 1



Ready...

TAPER-LOC[®] Tapers
 insert into the Base Shoe

Step 2

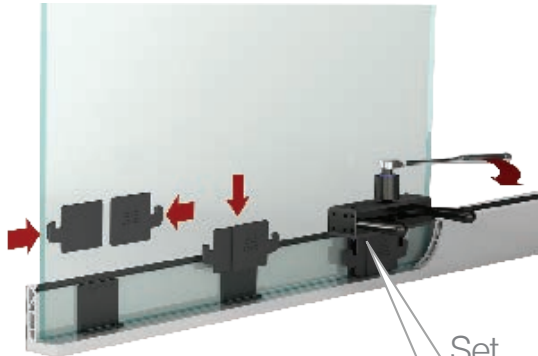

Set...

The TAPER-LOC[®] Installation Tool (TLK12) compresses the Tapers together with a predetermined torque setting. The glass is locked in to place every single time.

Step 3



Done.

CONFORMS TO
BS 6180: 2011





Easy Installation

The process of installing Glass Balustrades is now quick and easy with CRL's new and innovative TAPER-LOC® system.

TAPER-LOC® has a unique design that lets you apply precision tension to lock it in place, securing the glass in your aluminium base shoe without the use of messy cement. Your installation time is reduced by up to 50% while still exceeding code standards.



Adhere the L-Setting Blocks to the bottom of the glass panel.



Insert the Taper set half way down into the Base Shoe as shown, opposite the L-Setting Block, and then squeeze the Tapers together finger tight.



Place Installation/Removal Tool into position onto the Tapers and push them down into the Base Shoe.



Crank the Torque Wrench until the wrench clicks and breaks for a few degrees, letting you know the Tapers are locked to the correct measured torque.

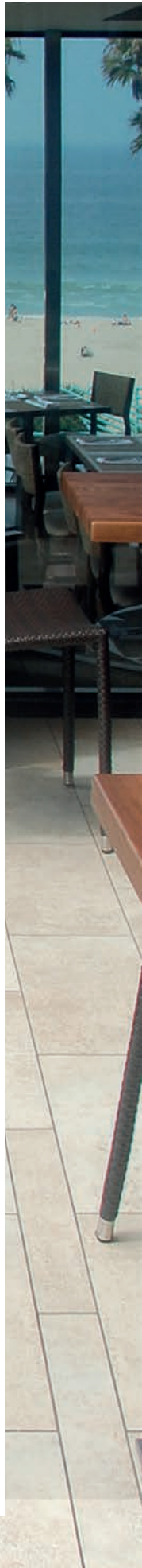

Conforming to Building Standards Across Europe

At CRL, we are committed to the testing and development of all of our products.

All CRL TAPER-LOC® Systems are independently tested to meet British, German, French and US Standards. We have solutions up to and including 3kN load tests.

Watch the video of our test in action at: www.taper-loc.co.uk/testrig



CRL Balustrade Test Rig









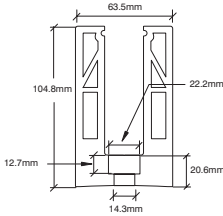

Our project testing facilities available upon request. Certificates available at www.taper-loc.co.uk

Contact Technical Sales on freephone 00 800 0421 6144

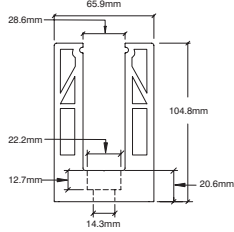

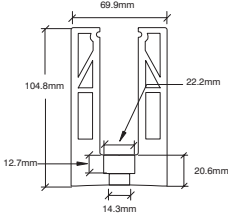
CRL TAPER-LOC® Frameless Glass Balustrade System

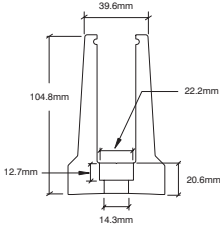
Base Shoes for Toughened Monolithic Glass

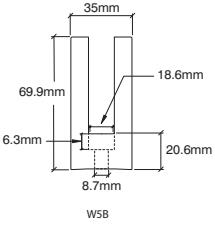
Base Shoe	To Suit Glass Thickness	Description	Measurements
	12mm	CRL 8B10 Series Standard Square Base Shoe <ul style="list-style-type: none"> • Pre-drilled • Works with TL5X10 TAPER-LOC® Taper Sets 	 <p>Stock Length: 3.05m Hole Size: 14.3mm Counter Bore: 22mm Depth: 12.7mm Centre to Centre: 305mm</p>
	15mm	CRL 8B58 Series Standard Square Base Shoe <ul style="list-style-type: none"> • Pre-drilled • Works with TL5X10 TAPER-LOC® Taper Sets 	 <p>Stock Length: 3m Hole Size: 14.3mm Counter Bore: 22mm Depth: 12.7mm Centre to Centre: 300mm</p>
	19mm	CRL 8B34 Series Heavy-Duty Square Base Shoe <ul style="list-style-type: none"> • Pre-drilled • Works with TL5X10 TAPER-LOC® Taper Sets 	 <p>Stock Length: 3.05m Hole Size: 14.3mm Counter Bore: 22mm Depth: 12.7mm Centre to Centre: 305mm</p>
	12mm	CRL B5T Series Tapered Base Shoe <ul style="list-style-type: none"> • Typically used as the Base Channel for Glass Railing Systems requiring a Flush Installation Embedded in Concrete • Works with TL5X10 TAPER-LOC® Taper Sets 	 <p>Stock Length: 3.05m Hole Size: 14.3mm Counter Bore: 22mm Depth: 12.7mm Centre to Centre: 305mm</p>
	10mm	CRL W5B Series Small Profile Windscreen Base Shoe <ul style="list-style-type: none"> • Pre-drilled • Works with TL3W10 TAPER-LOC® Taper Sets • Ideal for Windscreens and Privacy Partitions <p>NOTE: NOT SUITABLE FOR STRUCTURAL APPLICATIONS</p>	 <p>Stock Length: 3.05m Hole Size: 9mm Counter Bore: 18.6mm Depth: 6.3mm Centre to Centre: 305mm</p>







Base Shoe codes end with either 'D' or 'F' to determine Surface or Fascia Mounted.

D = Surface Mounted Base Shoe

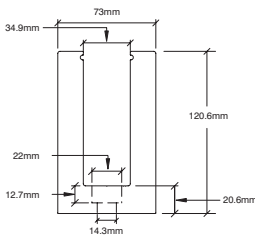
F = Fascia Mounted Base Shoe

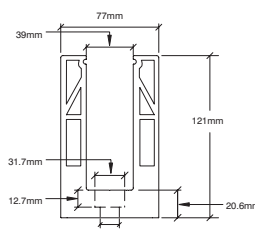
NOTE: Undrilled and fascia drilled base shoe available and in stock - contact Technical Sales for details. Minimum order: 1 each. All Base Shoe can be combined for quantity pricing. Must ship common carrier. Stock lengths have a tolerance of plus or minus 19mm.

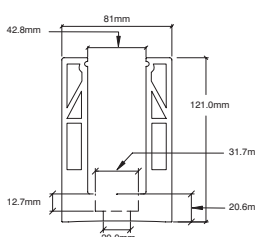
Base Shoes for Toughened Laminated Glass

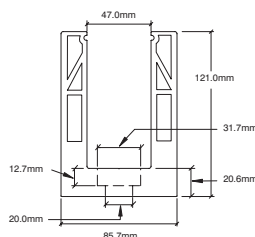
Base Shoe	To Suit Glass Thickness	Description	Measurements
 <p>L56S10D/F</p>	13.52mm	<p>CRL L56S Series Standard Square Base Shoe</p> <ul style="list-style-type: none"> • Pre-drilled • Works with LTL96X TAPER-LOC® Taper Sets 	 <p>Stock Length: 3.05m Hole Size: 14.3mm Counter Bore: 22mm Depth: 12.7mm Centre to Centre: 305mm</p>
 <p>9BL68D/F</p>	17.52mm	<p>CRL 9BL68 Series Standard Square Base Shoe</p> <ul style="list-style-type: none"> • Pre-drilled • Works with LTL96X TAPER-LOC® Taper Sets 	 <p>Stock Length: 3m Hole Size: 20mm Counter Bore: 31.7mm Depth: 12.7mm Centre to Centre: 300mm</p>
 <p>9BL21D/F</p>	21.52mm	<p>CRL 9BL21 Series Standard Square Base Shoe</p> <ul style="list-style-type: none"> • Pre-drilled • Works with LTL10X TAPER-LOC® Taper Sets 	 <p>Stock Length: 3m Hole Size: 20mm Counter Bore: 31.7mm Depth: 12.7mm Centre to Centre: 300mm</p>
 <p>9BL25D/F</p>	25.52mm	<p>CRL 9BL25 Series Heavy-Duty Square Base Shoe</p> <ul style="list-style-type: none"> • Pre-drilled • Works with LTL10X TAPER-LOC® Taper Sets 	 <p>Stock Length: 3m Hole Size: 20mm Counter Bore: 31.7mm Depth: 12.7mm Centre to Centre: 300mm</p>

Base Shoe codes end with either 'D' or 'F' to determine Surface or Fascia Mounted.
 D = Surface Mounted Base Shoe
 F = Fascia Mounted Base Shoe

NOTE: Undrilled and fascia drilled base shoe available and in stock - contact Technical Sales for details. Minimum order: 1 each. All Base Shoe can be combined for quantity pricing. Must ship common carrier. Stock lengths have a tolerance of plus or minus 19mm. CRL advise against pre-drilling the substructure prior to installation of base shoe.

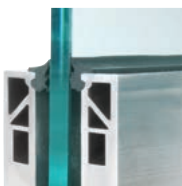

Gasket Retention Groove
 Secures the Top Rubber
 in the Base Shoe

For Information on Cladding, Gaskets, Taper options, End Caps and Tools please see www.taper-loc.co.uk or request our TAPER-LOC® brochure



Typical Installations

Concrete Substrate Typical Surface Mount Detail

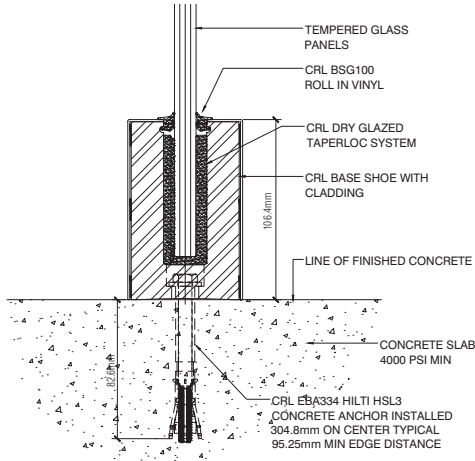

Concrete Substrate Typical Fascia Mount Detail

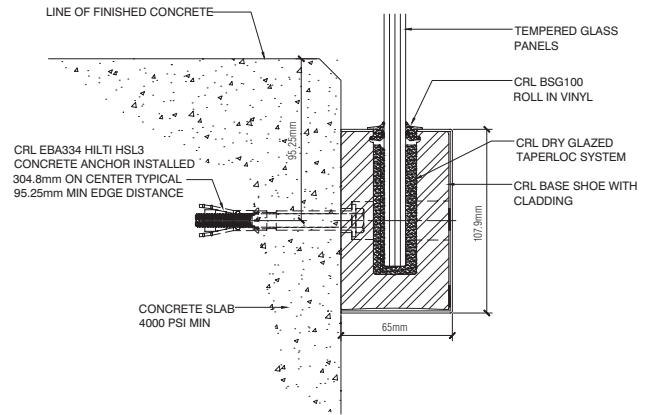

Steel Tube Substrate Typical Surface Mount Detail

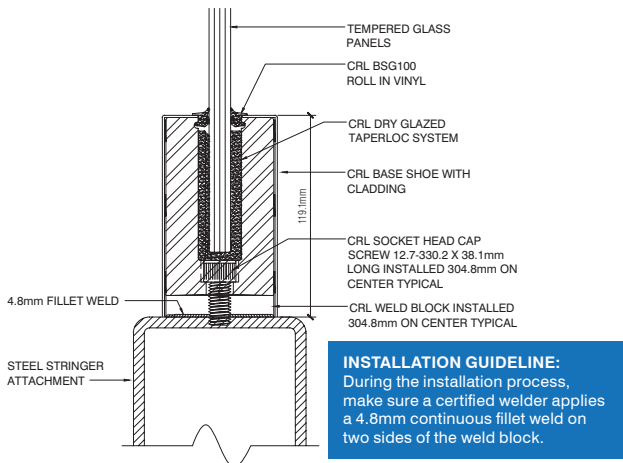

Steel Tube Substrate Typical Fascia Mount Detail

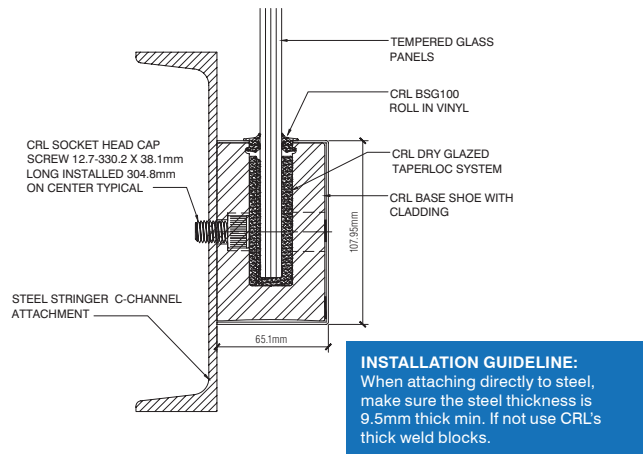



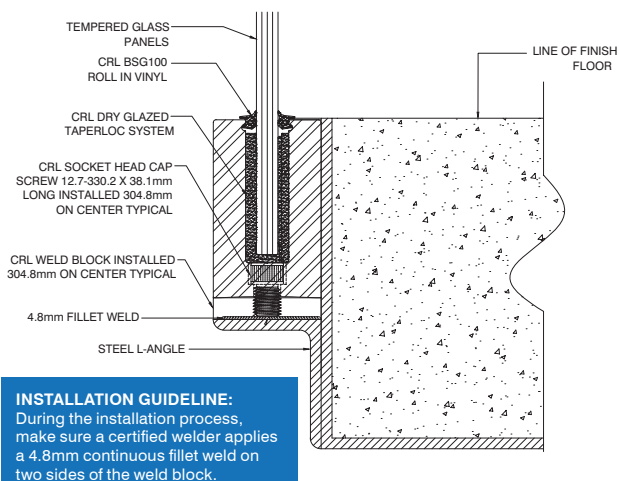





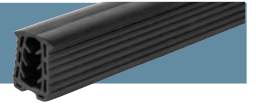

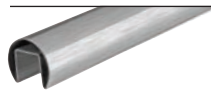
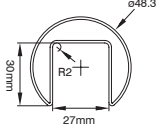

Steel L-Angle Substrate Typical Surface Mount Detail

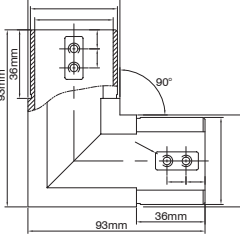

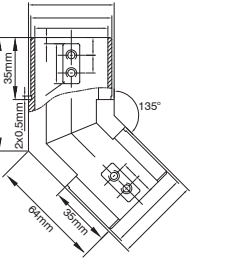
48.3mm Diameter Hand Rail Components

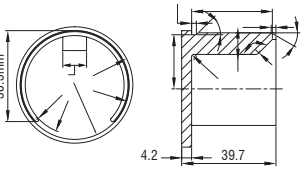
For vinyl inserts see page 34

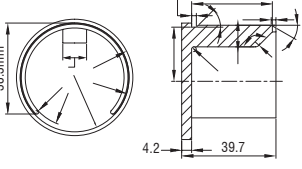



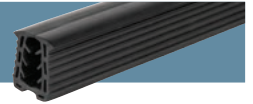

	CAT. NO.	DESCRIPTION
 	<p>EUGR20BS Brushed Stainless Steel - 3m Length</p> <p>EUGR20BS14 Brushed Stainless Steel - 4.2m Length</p> <p>EUGR20PS Polished Stainless Steel - 3m Length</p> <p>EUGR20PS14 Polished Stainless Steel - 4.2m Length</p>	<p>Cap Rail</p> <ul style="list-style-type: none"> • For 12mm to 25.52mm glass with silicone • 316 stainless steel • Connects to a variety of fabricated corners and end caps 
	<p>EUGR20CSS Brushed Stainless</p>	<p>Internal Connector</p> <ul style="list-style-type: none"> • Used with 48.3mm cap rail • 316 grade stainless steel
 	<p>EUGR20HBS Brushed Stainless Steel</p> <p>EUGR20HPS Polished Stainless Steel</p>	<p>90° Corner</p> <ul style="list-style-type: none"> • Used with 48.3mm cap rail • 316 grade stainless steel • Available in brushed and polished stainless steel
 	<p>EUGR20H3BS Brushed Stainless Steel</p> <p>EUGR20H3PS Polished Stainless Steel</p>	<p>135° Corner</p> <ul style="list-style-type: none"> • Used with 48.3mm cap rail • 316 grade stainless steel • Available in brushed and polished stainless steel
 	<p>EUGR20ECBS Brushed Stainless Steel</p> <p>EUGR20ECPS Polished Stainless Steel</p>	<p>End Cap</p> <ul style="list-style-type: none"> • Used with 48.3mm cap rail • 316 grade stainless steel • Available in brushed and polished stainless steel • Polished Stainless Steel comes with fixing screws
 	<p>EUGR20SECBS Brushed Stainless Steel</p> <p>EUGR20SECPS Polished Stainless Steel</p>	<p>Securing End Cap</p> <ul style="list-style-type: none"> • Used with 48.3mm cap rail • 316 grade stainless steel • Available in brushed and polished stainless steel • Comes with fixing screws 

Square Hand Rail Components

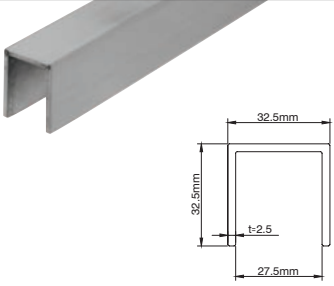
For vinyl inserts see page 34

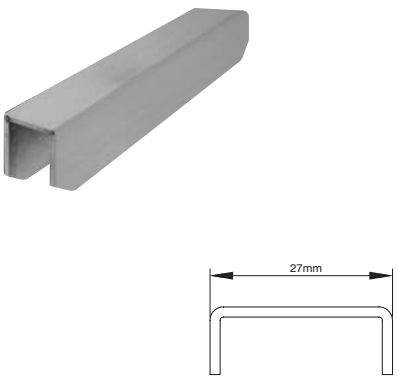

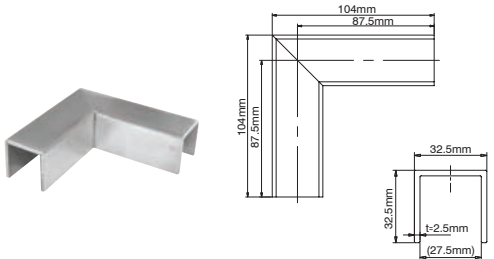
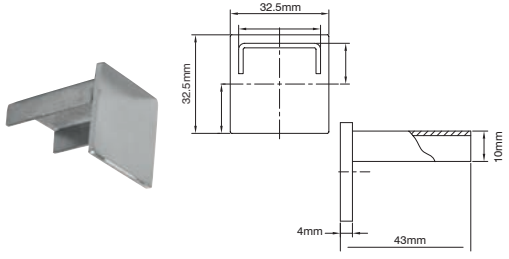
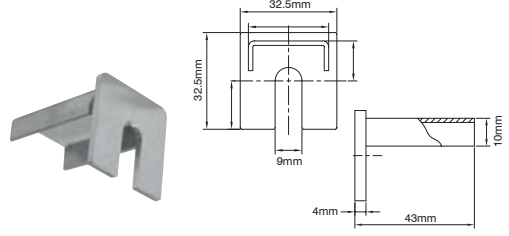

CAT. NO.	DESCRIPTION
	<p>EUL10BS Brushed Stainless Steel</p> <p>EUL10PS Polished Stainless Steel</p> <p>3m Cap Rail</p> <ul style="list-style-type: none"> • 32mm x 32.5mm x 2.5mm • Sold per 3 metre length • To be used with 12mm to 21.52mm glass only • 316 grade stainless steel 
	<p>EUL10CSS</p> <p>Connectors</p> <ul style="list-style-type: none"> • 32mm x 32.5mm x 2.5mm internal 180 degree connector sleeve • To be used with 12mm to 21.52mm glass only • 316 grade stainless steel <p><i>316 grade brushed stainless steel internal connector sleeve to be used with EUL10BS and EUL10PS cap rail</i></p> 
	<p>EUL10HBS Brushed Stainless Steel</p> <p>EUL10HPS Polished Stainless Steel</p> <p>90° Corner</p> <ul style="list-style-type: none"> • 32mm x 32.5mm x 2.5mm • To be used with 12mm to 21.52mm glass only • 316 grade stainless steel
	<p>EUL10ECBS Brushed Stainless Steel</p> <p>EUL10ECPS Polished Stainless Steel</p> <p>End Caps</p> <ul style="list-style-type: none"> • 32mm x 32.5mm x 2.5mm • To be used with 12mm to 21.52mm glass only • 316 grade stainless steel
	<p>EUL10SECBS Brushed Stainless Steel</p> <p>EUL10SECPS Polished Stainless Steel</p> <p>Securing End Caps</p> <ul style="list-style-type: none"> • 32mm x 32.5mm x 2.5mm • To be used with 12mm to 21.52mm glass only • 316 grade stainless steel

Vinyl Inserts

For use with EUGR20 and EUL10 Cap Rails on pages 32 & 33

	CAT. NO.	DESCRIPTION
	EUGR5PV 3m Length EUGR5PV14 4.2m Length	Vinyl Insert for 12mm Glass <ul style="list-style-type: none"> • Sold per 3m or 4.2 metre length • Used with 48.3mm cap rail for 12mm glass • Cap rail vinyl
	EUGR6PV 3m Length EUGR6PV14 4.2m Length	Vinyl Insert for 15mm Glass <ul style="list-style-type: none"> • Sold per 3m or 4.2 metre length • Used with 48.3mm cap rail for 15mm glass • Cap rail vinyl
	EUGR7PV 3m Length EUGR7PV14 4.2m Length	Vinyl Insert for 19mm Glass <ul style="list-style-type: none"> • Sold per 3m or 4.2 metre length • Used with 48.3mm cap rail for 19mm glass • Cap rail vinyl
	EUGR56PV 3m Length EUGR56PV14 4.2m Length	Vinyl Insert for 13.52mm Glass <ul style="list-style-type: none"> • Sold per 3m or 4.2 metre length • Used with 48.3mm cap rail • Cap rail vinyl
	EUGR68PV 3m Length EUGR68PV14 4.2m Length	Vinyl Insert for 17.52mm Glass <ul style="list-style-type: none"> • Sold per 3m or 4.2 metre length • Used with 48.3mm cap rail • Cap rail vinyl
	EUGR21PV 3m Length EUGR21PV14 4.2m Length	Vinyl Insert for 21.52mm Glass <ul style="list-style-type: none"> • Sold per 3m or 4.2 metre length • Used with 48.3mm cap rail • Cap rail vinyl

Contact Cement

	CAT. NO.	DESCRIPTION
	<p>32629 Contact Cement</p> <p>7649 60 Second Primer</p>	<p>CRL Loctite® Metal Contact Cement</p> <ul style="list-style-type: none"> • The strength of an epoxy and the speed of an instant adhesive • Permanently bonds cap rails, hand rails, and their accessories with superior strength holding power up to 4,900psi • Offers handling strength in 60 seconds, full cure in 24 hours <p>CRL Loctite® 60 Second Primer for Metal Contact Cement</p> <ul style="list-style-type: none"> • Use with Cat. No. 32629 for 60 second activation • Single component non-CFC solvent based surface activator
	<p>81120</p>	<p>CRL Clear Loctite® Poxy-Pak™ Two-Part Epoxy</p> <ul style="list-style-type: none"> • Pre-measured resin and hardener for easy application, consistent strength • Resealable - no waste • Bonds virtually any material

Expanding Cement

	CAT. NO.	DESCRIPTION
	<p>KWX25 11.3kg</p> <p>KWX50 22.6kg</p>	<p>CRL Kwixset® Expanding Cement</p> <ul style="list-style-type: none"> • Kwixset® for exterior and interior applications • Great for setting core mount stanchions for vertical posts • Expand as they set • Fast setting, they will not shrink or crack when used as directed • Just mix with water • No shrinking and cracking

Silicone

	CAT. NO.	DESCRIPTION
	<p>EURTV408C Clear</p> <p>EURTV408W White</p> <p>EURTV408BL Black</p> <p>EURTV408BR Brown</p> <p>EURTV408G Grey</p> <p>EURTV408A Anthracite</p> <p>EURTV408R Rosewood</p> <p>ANTI-FUNGAL</p>	<p>CRL Neutral Cure Low Modulus Silicone</p> <ul style="list-style-type: none"> • Low odour, neutral cure formula • Compatible with insulating glass glazing • Excellent adhesion to most surfaces • Low modulus • High grade formula - low shrinkage • 300ml cartridge, 12 per case • Special countertop display box • Conforms to ISO 11600



Juliette
Balconies

CAT. NO.

DESCRIPTION



EUGR20JBS
Brushed Stainless Steel

EUGR20JPS
Polished Stainless Steel

CRL Juliette Balcony Connector

- For use with the 48.3mm EUGR20 Cap Rail
- 316 Grade Stainless Steel
- Tested to a width of 2400mm certificate available
- Single pane of glass must be used for all widths of Juliet Balconies when using these products

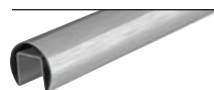
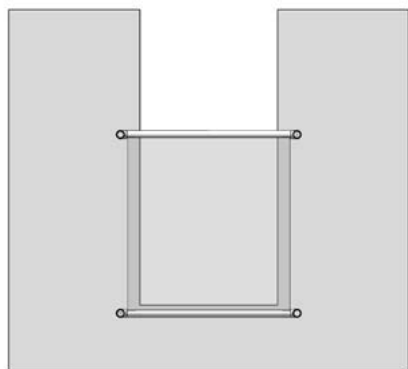
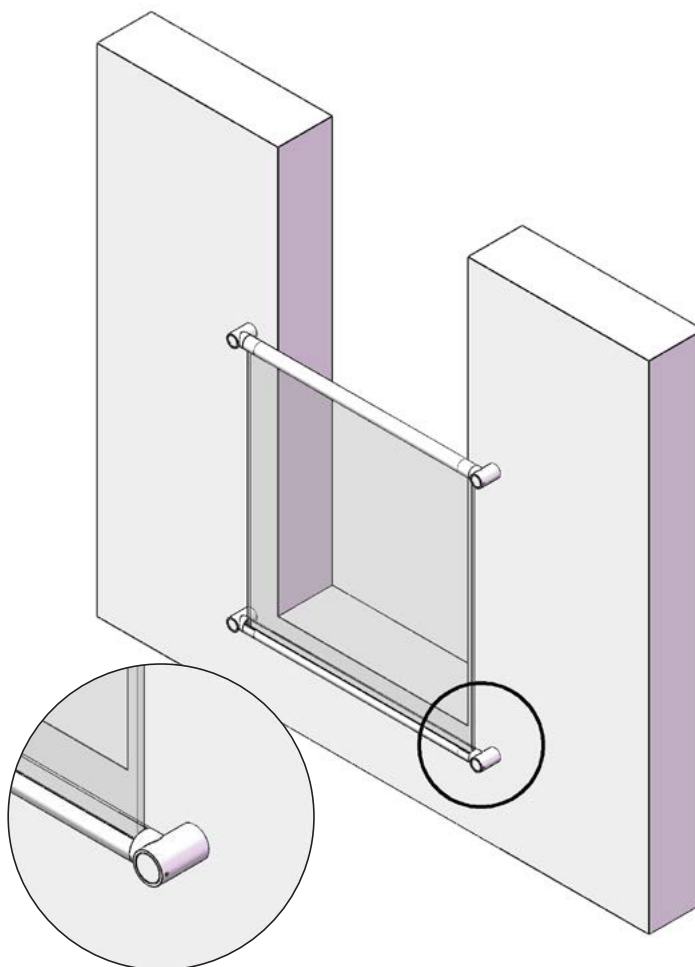
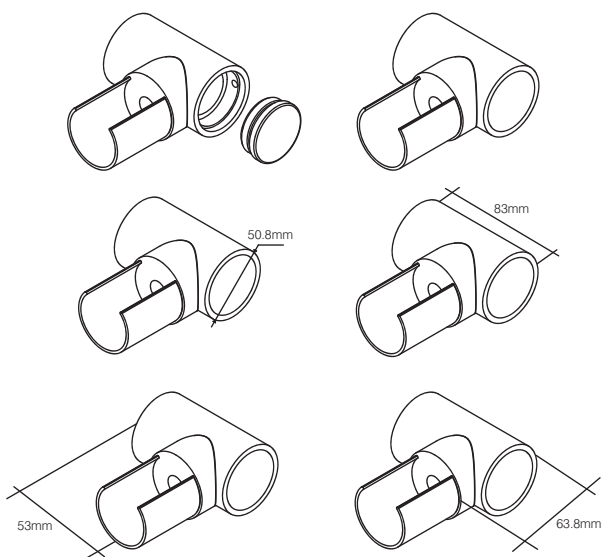

EUGR20BS
Brushed Stainless Steel 3m Length

EUGR20BS14
Brushed Stainless Steel 4.2m Length

EUGR20PS
Polished Stainless Steel 3m Length

EUGR20PS14
Polished Stainless Steel 4.2m Length

48.3mm Diameter Cap Rail

- For 12mm to 25.52mm glass
- Connects to a variety of fabricated corners and end caps

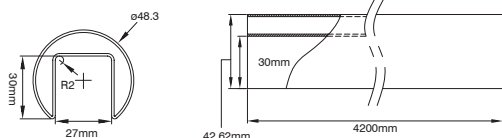

For Vinyl Inserts please see page 34

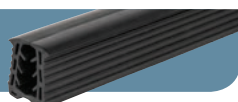



CRL Paris Balcony

CRL Paris



No handrail required



Profile in white (RAL 9016),
grey (RAL 7016) and raw



2 mm thin flat profile only
for glass edge protection



AbP provides security in
planning and execution



No disturbed view unlike
with conventional picket style
balconies

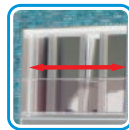

Tested to a width of 3 metre max



No visible screws in profile

- Safe design for vertically fixed glass with fixings of categories A or C according to EN 18008-4
- Narrow profile of 55 mm width and 42 mm depth
- Profiles to mount onto the window frames
- All gaskets coated with sliding polymer, suitable for self-cleaning glazing
- Glass thicknesses from 10 up to 21 mm
- Glass width: from 500 mm to 3,000 mm
- Glass height: from 400 mm to 1,200 mm

HEIGHT	GLASS WIDTH	COLOUR	CAT. NO.
1000 mm	Up to 1200 mm in 10.76 or 11.52 mm glass	Aluminium raw	FRBA3
	Up to 1400 mm in 12.76 or 13.52 mm glass	White RAL 9016	FRBA3W
		Grey RAL 7016	FRBA3GR
1000 mm	Up to 1600 mm in 16.76 or 17.52 mm glass	Aluminium raw	FRBA4
	Up to 3000 mm in 20.76 or 21.52 mm glass	White RAL 9016	FRBA4W
		Grey RAL 7016	FRBA4GR

Delivery for all sets

DESCRIPTION	QUANTITY
Base profile	2 Each
Top profile	2 Each
Accessory kit (top and bottom glass supports, end caps and spacers)	1 Piece
Vinyls for top profiles	2 Each
Vinyls for base profiles	2 Each
Mounting screws	8 Each (in 1000 and 900 mm) 6 Each (in 800 mm) 4 Each (in 450 mm)
Fixing screws	4 Each

CRL Frameless Windscreen Clamp System

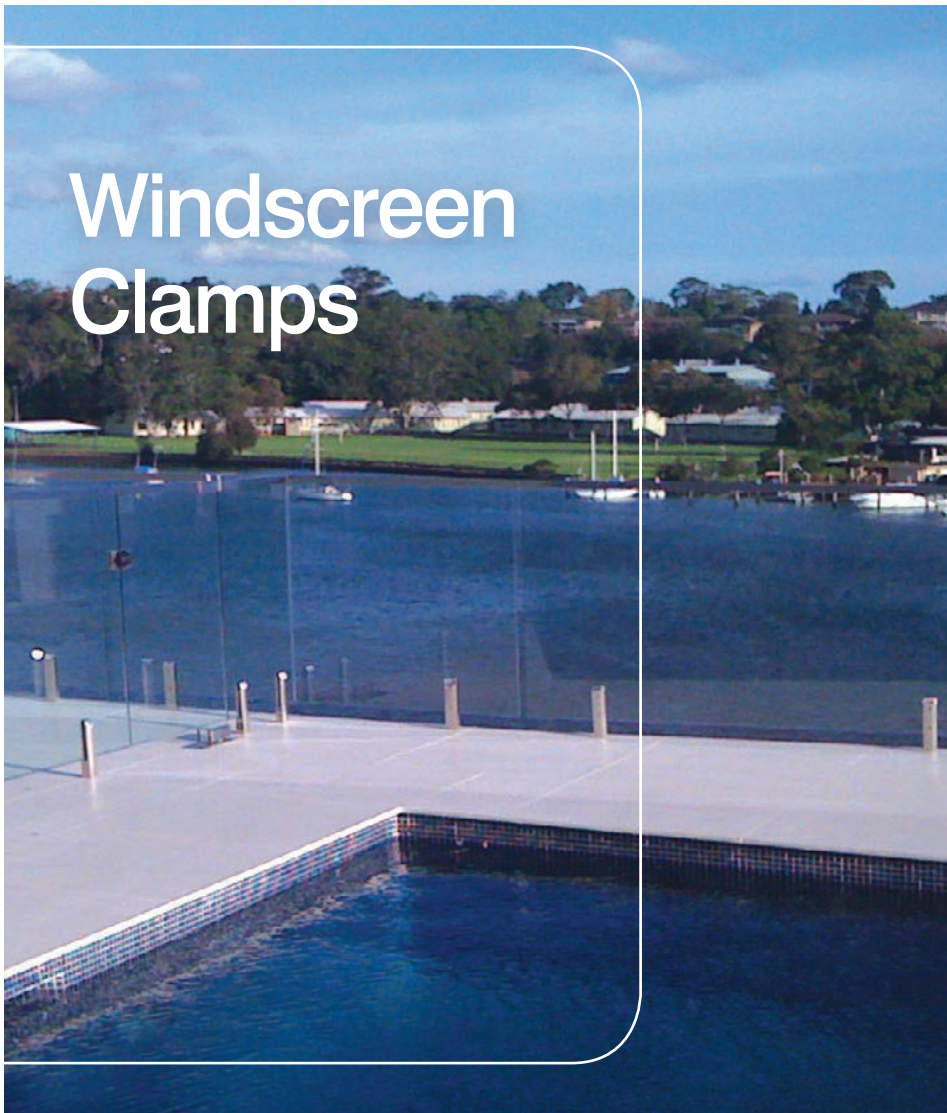

- Also known as spigots
- Gives an 'all-glass' frameless look
- Great for pool fencing, balcony, and deck applications
- Available in two standard architectural finishes
- 316 alloy and duplex 2205 marine grade finishes
- Designed for 12mm toughened glazing

Our Frameless Windscreen Clamps, which are also known as spigots, provide a break from the wind using an almost invisible "frameless" look. No vertical posts are used between the panels of glass; they are solely supported from the bottom by these high strength stainless steel clamps.



CODE DESCRIPTION



AFWC1
Brushed Stainless
AFWC6
Polished Stainless

CRL One-Piece Core Mount Clamp with Fixing Rod

- 30mm rod easily inserts into core-drilled hole

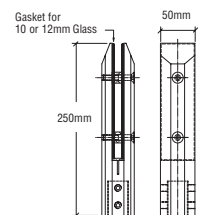

AFWC1SBS
Brushed Stainless
AFWC1SPS
Polished Stainless

One-Piece Bevelled Surface Mount Clamp

- Stable mount clamp for light installation
- With base cover

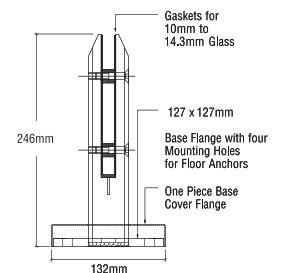

CODE

DESCRIPTION



AFWC2
Polished Stainless
AFWC7
Brushed Stainless

CRL Two-Piece Side Mount Clamp
• Mounts on face of wall or planter box

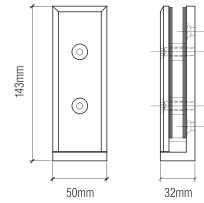

AFWC3
Brushed Stainless
AFWC8
Polished Stainless

CRL Three-Piece Core Mount Clamp with Fixing Rod
• 16mm rod easily inserts into core-drilled hole

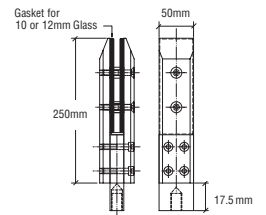

DFWC3
Brushed Stainless

CRL Three-Piece Core Mount Clamp
• Duplex 2205 grade stainless has higher corrosive resistance

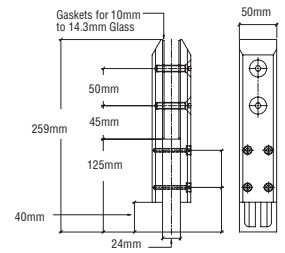

AFWC4SBS
Brushed Stainless
AFWC4SPS
Polished Stainless

CRL One-Piece Low Profile Surface Mount Clamp
• Stable mount clamp for light installation
• With base cover

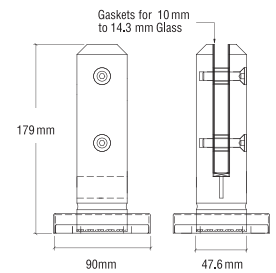

AFWC1G
Fits AFWC1
AFWC6G
Fits AFWC6
AFWC3G
Fits AFWC3
AFWC8G
Fits AFWC8

CRL Base Covers for Windscreen Clamps
• Base covers easily slip over the frameless windscreen clamp

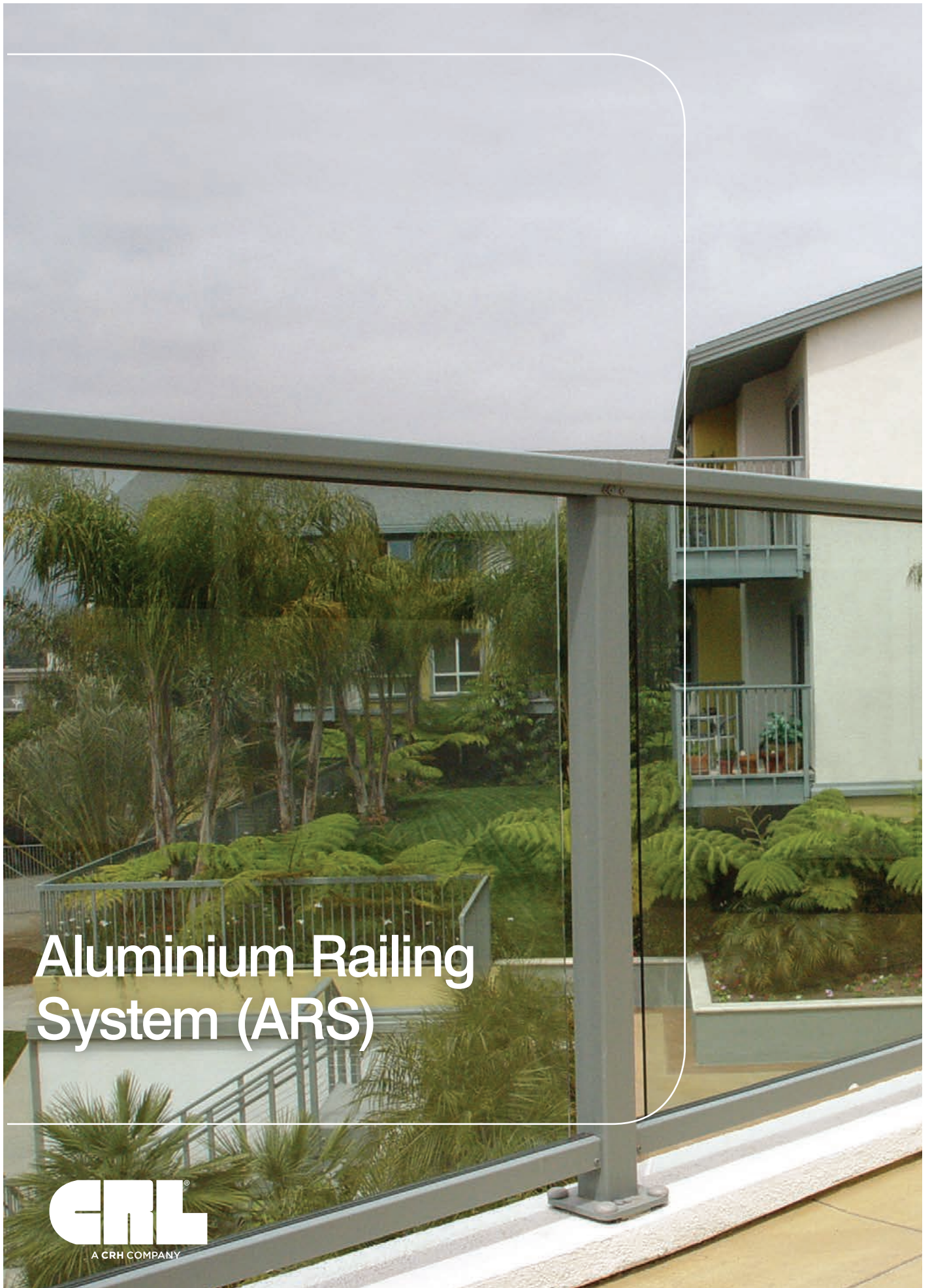

Aluminium Railing System (ARS)



A CRH COMPANY



CRL's high quality commercial or residential Aluminium Railing Systems are manufactured from extruded aluminium frames utilising toughened glass or aluminium pickets.

Our railing systems provide superior colour retention, impact and weather resistance in any environment.

For more information call FREE on
00 800 0421 6144

f: 00 800 0262 3299

CRL ARS Aluminium Railing System



Aluminium Railing Systems

- 60.3mm square posts available
- Available from stock in black, white and silver
- Custom finishes also available

Design Options

- Exterior and interior hand use
- Infill panel options: aluminium pickets, aluminium pattern panels, clear or coated structural glass, or stainless steel cable
- Custom gates
- ADA compliant grab rails
- Attractive low-voltage, post mounted lighting system for our railing systems. Using a safe, 12 volt power source, these lights provide a subtle glow that is sure to enhance any balcony environment. Contact CRL Technical Sales for further information.

Component Features and Benefits

- Innovative design details for standard or custom applications
- Extruded aluminium for durability, weather resistance, and low maintenance
- Heavy gauge materials and steel embeds for strength
- Uses 6mm to 12mm toughened glass for safety and impact resistance
- 6mm and 10mm using gasket. 12mm using wet glaze



Colour Selection

- Tough, powder-coated or optional kynar paint colours for superior colour retention and weather resistance
- Special coating for resistance to salt water corrosion

Standard Colours

- In-house factory applied
- Baked on TGIC polyester powder coat paint system
- Excellent weather resistance and durability
- Meets AAMA 2603-98 specifications

Additional Colour Options

- A variety of textured and performance enhanced powder coat paint systems
- Custom colour matching
- All paint systems will be applied over state-of-the-art chromate pre-treatment

Stock and custom finishes are shown below with their colour codes. Add the chosen colour code to a Cat No to complete your product code.

Note: Colours shown are representative only, and may vary slightly from actual gloss, colour, and texture. If colour match is critical, please contact Technical Sales for additional information.

Stocked Finishes

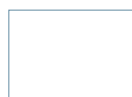

Sky White - Gloss
CODE W



Black - Matte
CODE BL

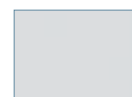

Silver - Metallic
CODE S

Custom finishes (available on request)

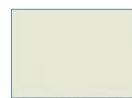

Oyster White - Gloss
CODE OW



Bronze - Matte
CODE BRZ

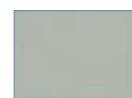

Agate Grey - Gloss
CODE AGY

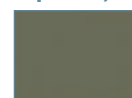

Beige Grey - Gloss
CODE BGY

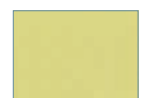

Unfinished Chromate
CODE CRM

CRL ARS Aluminium Railing System Mounting Options

One benefit of the ARS System is that it attaches to just about any substrate with our standard Surface Mount Base Plates. However, you do have additional mounting options, as illustrated below.

Our specially formulated coatings are designed to resist the corrosive effects of salt water, providing a permanent, worry-free addition to your building.

The CRL Aluminium Railing System is designed to meet all Guard Rail Safety Codes, and with so many options, there is a railing system for every application.

Typical Mounting Options

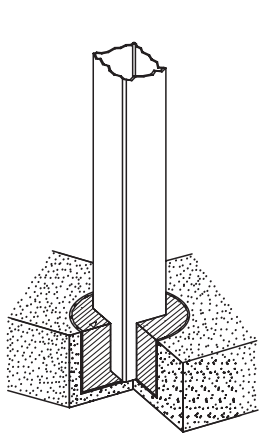

Core Mounted Installation

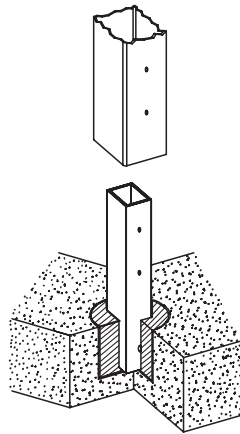

Core Mounted With Stanchion Installation

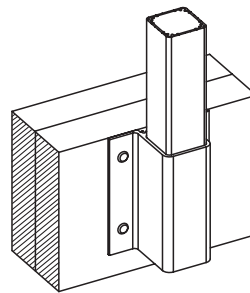

Fascia Mounted Installation

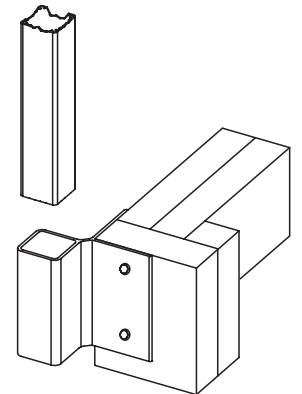

Corner Fascia Mount Installation

Core

Fascia

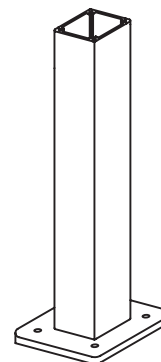
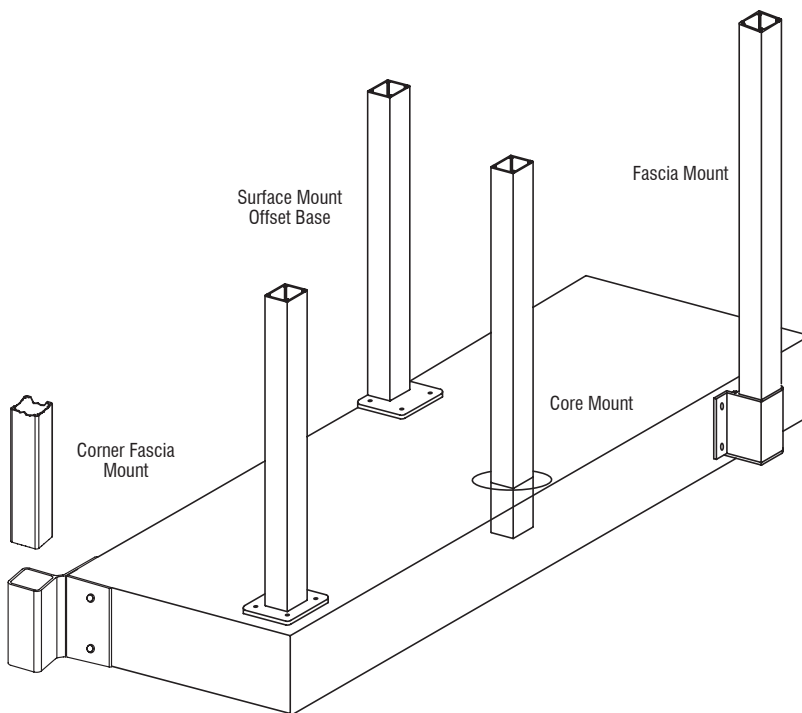

Surface Mounted Standard Base With Moisture Barrier Gasket Between Bracket and Substrate

Surface

Basic Installation Instructions

1. Post Installation

Install End and Corner Posts first, then continue with Intermediate Posts. Be sure to place Stainless Steel Washers under the Bolts so that the Bolt Cover Buttons can be attached. Ensure that Posts are plumb and level. **NOTE:** When installing Post on top of concrete, brick, masonry, or stucco, always make sure to install the Moisture Barrier Gasket between the substrate and the Bottom Plate.

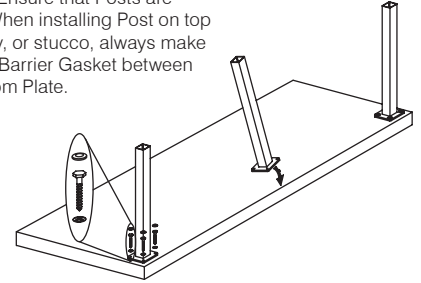

2. Cap Rail Installation

Measure and cut the Cap Rail to length. Attach the Cap Rail to the Posts using Self Tapping Screws. Install the End Caps with provided screws.

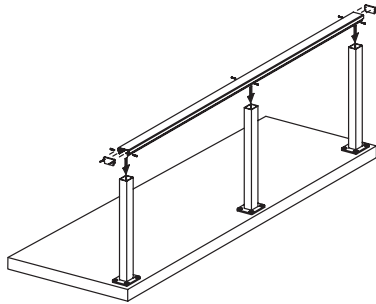

3. Rail Connecting Blocks

Install the Rail Connecting Blocks onto the Posts using the Self Tapping Screws provided. These Blocks are used to support the Bottom Rail.

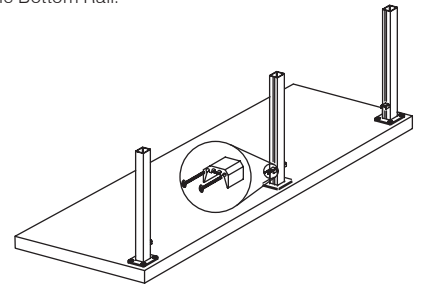

4. Top Rail Infill and Bottom Rail

Cut Top Rail Infill and Bottom Rail to length. Snap fit the Top Rail Infill into the Top Cap Rail. Mount the Bottom Rail onto the Blocks and secure with Tek Screws.

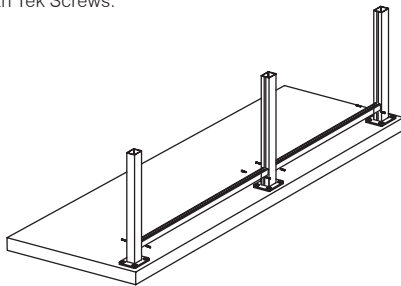

5. Vinyl Installation (Glass Panels Only)

Snap fit Top Vinyl into Top Cap Rail insert.
Snap fit Bottom Vinyl into Bottom Rail.

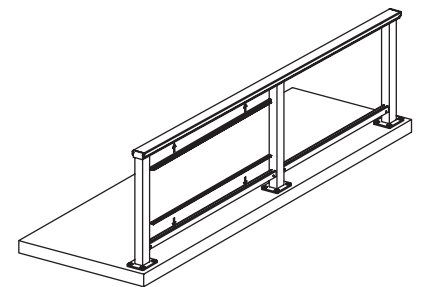

6. Glass Installation (Glass Panels Only)

Push Glass up into the Vinyl. Align Glass with Bottom Vinyl and push down into Vinyl. Align Glass horizontally.

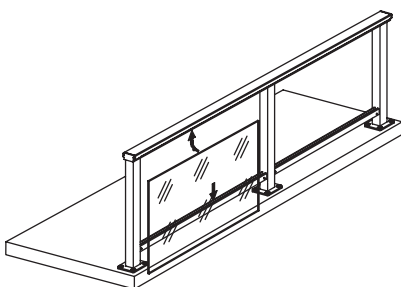

7. Picket Installation

Follow above steps 1, 2, and 3 only. Screw Pickets to the Top Cap Infill and the Bottom Rail. Snap fit top into Top Rail and install Bottom Rail over Blocks. Secure Bottom Rail to Blocks with Tek Screws.

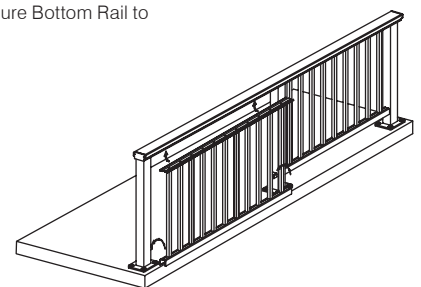

CRL ARS 200 Series Railing System



200 Series

Top Rail

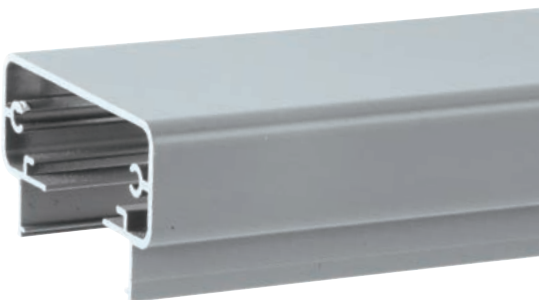
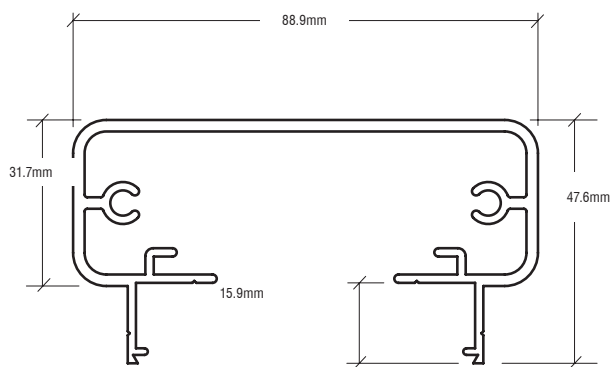

200 Series Top Rail
Cat. No. 2TR241XX

Glass Infill
Cat. No. 1FGLSXX

Top Glazing Vinyl
Cat. No. 14TV (6mm)
or 38TV (10mm)

60.3mm Square Post
Cat. No. P241

Bottom Glazing Vinyl
Cat. No. 14BV (6mm)
or 38BV (10mm)

200 Series Bottom Rail
Cat. No. BRGLSXX

Rail Connecting
Block Screws
Cat. No. RCBS

Rail Connecting Block
Cat. No. RCB2

127mm Square Base Plate
Cat. No. BP5

Moisture Barrier Gasket
Cat. No. BPG1BL

200 Series

Our 200 Series Railing System uses a continuous flat top rail, which helps achieve a modern look. While most companies in the industry offer very typical top rails, the 200 Series maintains an extremely low profile while outperforming competitive systems for strength and durability. At 47.6mm it has the lowest profile of all the top rails.

NOTE: As good as the 200 Series is, you cannot use it for a stair application where railing is required. The top cap is too wide in cross section to achieve the status of a hand rail. This being the case, you must use our 100 Series for the stair portion of the job. Contact CRL Technical Sales for further information.



- 6005-T5 aluminium alloy
- Standard rail heights are 914mm, 1066mm and 1219mm. Custom rail heights also available
- 60.3mm square aluminium post
- Infill panel options: 6mm or 10mm glass (not supplied by CRL), 19mm square or round profile aluminium picket panels
- Also 12mm glass when used with wet glaze method 6mm and 10mm using gasket
- Deck (top) mount or fascia mount applications available
- Core mount applications also available
- Can be fabricated with custom gates
- Exterior and interior applications
- A.D.A. compliant guard rails
- 1524mm recommended post spacing

Infill Options

CRL offers glass Infill Panel System or the Picket style shown below.

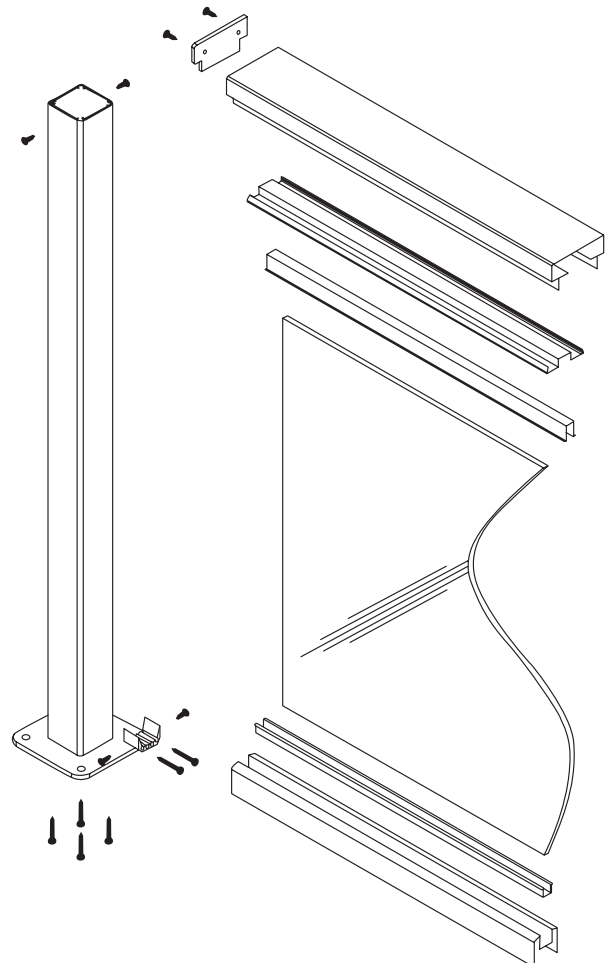
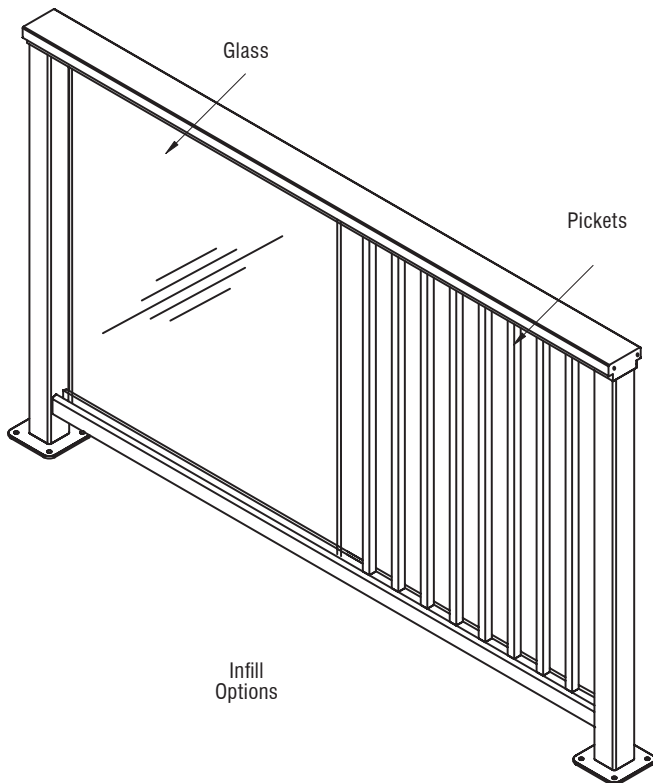

CRL ARS 300 Series Railing System



300 Series

Top Rail

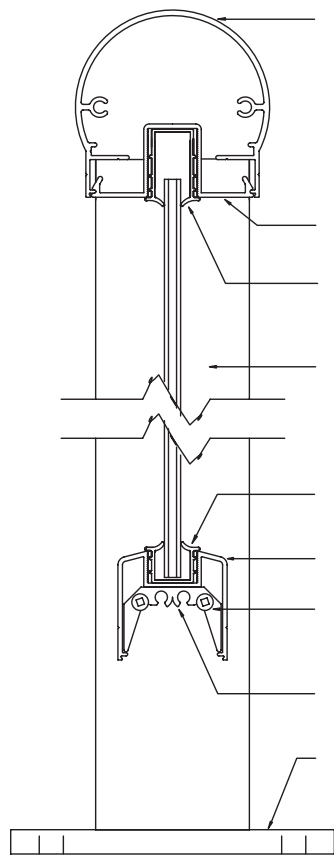
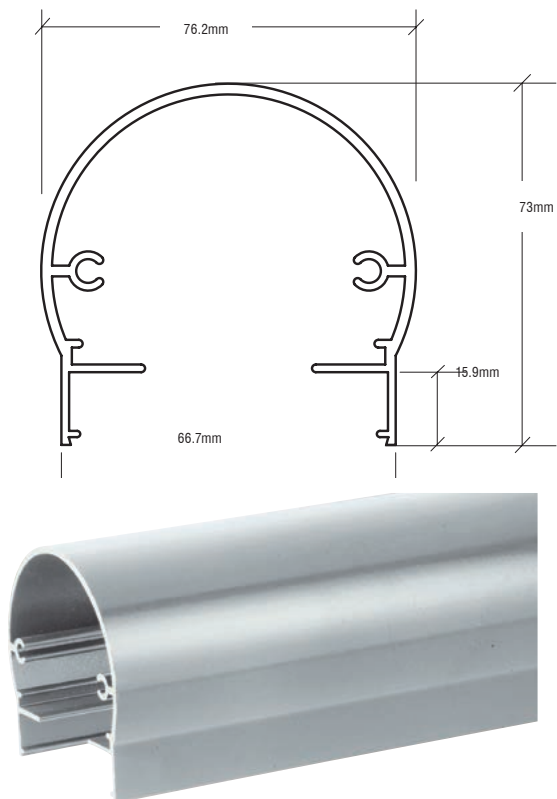

- 300 Series Top Rail
Cat. No. 3TR241
- Glass Infill
Cat. No. 1FGLS
- Top Glazing Vinyl
**Cat. No. 14TV (6mm)
or 38TV (10mm)**
- 60.3mm Square Post
- Bottom Glazing Vinyl
**Cat. No. 14BV (6mm)
or 38BV (10mm)**
- 300 Series Bottom Rail
Cat. No. BRGLS
- Rail Connecting Block Screws
Cat. No. RCBS
- Rail Connecting Block
Cat. No. RCB2
- 127mm Square Base Plate
Cat. No. BP5
- Moisture Barrier Gasket

Cat. No. BPG1BL

300 Series

The 300 Series offers the largest profile of all our top rails. At 73mm high the 300 Series offers a stylish and continuous large round top rail, while maintaining the strength and durability of all of our Aluminium Railing Systems.

NOTE: You cannot use the 300 Series for a stair application where railing is required. The top cap is too wide in cross section to achieve the status as a hand rail. You must use our 100 Series for the stair portion of the job. Contact CRL Technical Sales for further information.



- 6005-T5 aluminium alloy
- Standard rail heights are 914mm, 1066mm and 1219mm. Custom rail heights also available
- 60.3mm square aluminium post
- Infill panel options 6mm or 10mm glass (not supplied by CRL), 19mm square or round profile aluminium picket panels, stainless steel cable, or decorative cast panels
- Also 12mm glass when used with wet glaze method 6mm and 10mm using gasket
- Deck (top) mount or fascia mount applications
- Core mount applications also available
- Exterior and interior applications
- Can be fabricated with custom gates
- A.D.A. compliant guard rails
- 1524mm recommended post spacing

Infill Options

CRL offers glass Infill Panel System or the Picket style shown below.

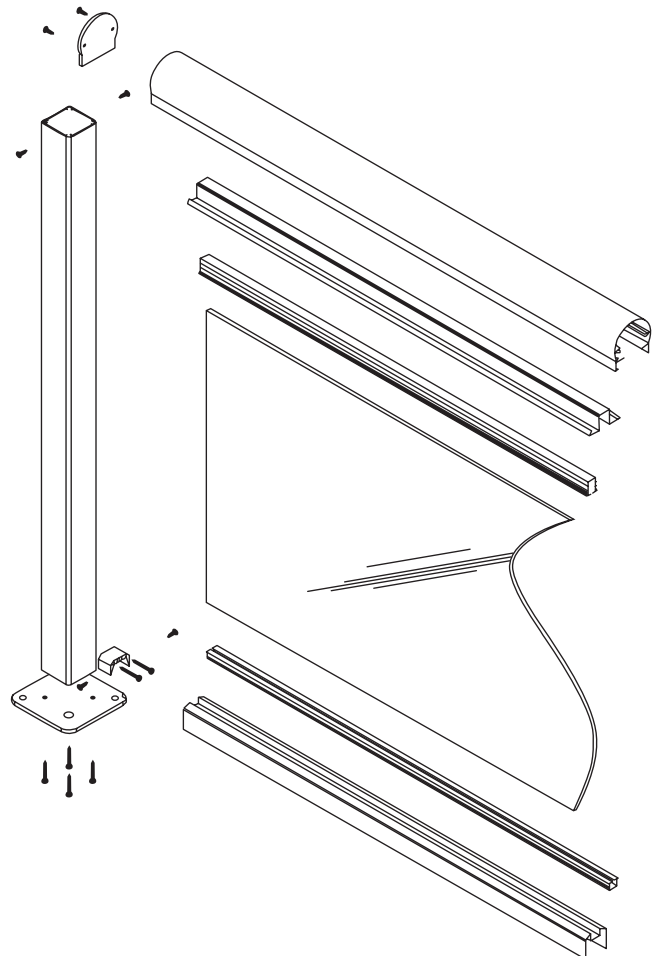
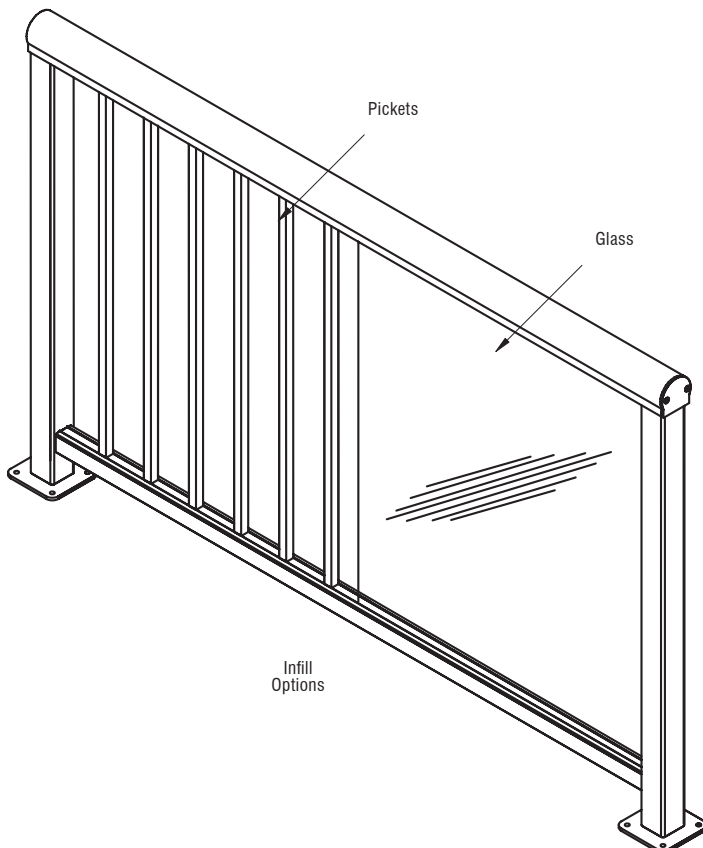



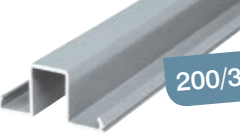
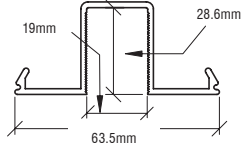
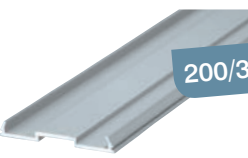
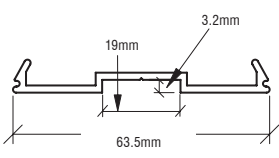

CODE	DESCRIPTION	
 <p>2TR241XX 200 Series</p>	<p>200 Series Top Rail</p> <ul style="list-style-type: none"> Designed to accommodate 19mm pickets or 6mm to 12mm* toughened glass * 12mm glass only if wet glazed. 6 and 10mm using gasket. 	
 <p>3TR241XX 300 Series</p>	<p>300 Series Top Rail</p> <ul style="list-style-type: none"> For use with 19mm pickets or 6mm to 12mm* toughened glass * 12mm glass only if wet glazed. 6 and 10mm using gasket. 	

CRL Top Rail Infills



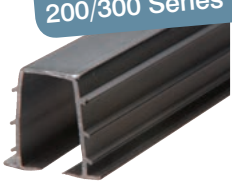
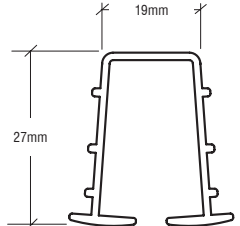

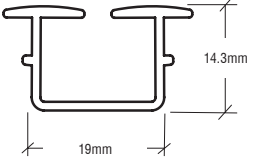

 <p>1FGLSXX 200/300 Series</p>	<p>Top Rail Infill for Glass</p> <ul style="list-style-type: none"> Easily snap into the underside of the top rail For use with 19mm Pickets or 6mm to 12mm* toughened Glass * 12mm glass only if wet glazed. 6 and 10mm using gasket. 	
 <p>1FPKTXX 200/300 Series</p>	<p>Top Rail Infill for Pickets</p> <ul style="list-style-type: none"> Easily snap into the underside of the top rail For use with 19mm square or round pickets Also available pre-punched for pickets. 	

CRL Glazing Vinyl

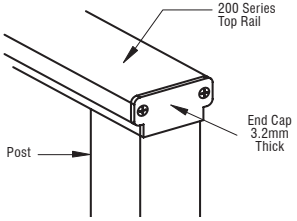

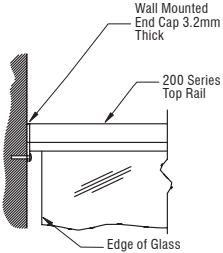
 <p>14TV Top Vinyl for 6mm Thick Glass</p> <p>38TV Top Vinyl for 10mm Thick Glass</p>	<p>Glazing Vinyl Top</p> <ul style="list-style-type: none"> Rigid glazing vinyl is designed to snap in before the glass is installed Two sizes for use with 6mm or 10mm thick toughened glass 	
 <p>14BV Bottom Vinyl for 6mm Thick Glass</p> <p>38BV Bottom Vinyl for 10mm Thick Glass</p>	<p>Glazing Vinyl Bottom</p> <ul style="list-style-type: none"> Rigid glazing vinyl is designed to snap in before the glass is installed Two sizes for use with 6mm or 10mm thick toughened glass 	

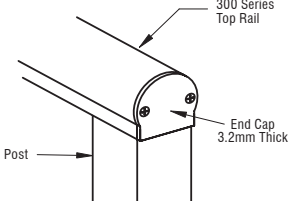
CRL End Caps for 200 and 300 Series Rails

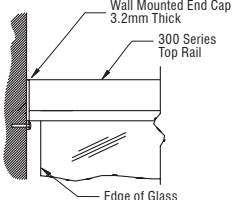
XX = Colour Code. Refer to page 45 for colour range and codes

CODE	DESCRIPTION
<p>2DECXX</p> 	<p>Decorative End Caps</p> <ul style="list-style-type: none"> Countersunk for end cap screws Matches contours of top rail ECS1 screws sold separately 
<p>2WECXX</p> 	<p>Wall Mount End Caps</p> <ul style="list-style-type: none"> Countersunk for end cap screws Designed for wall mounting the top rail ECS1 screws sold separately 
<p>3DECXX</p> 	<p>Decorative End Caps</p> <ul style="list-style-type: none"> Countersunk for end cap screws Matches contours of top rail ECS1 screws sold separately 
<p>3WECXX</p> 	<p>Wall Mount End Caps</p> <ul style="list-style-type: none"> Countersunk for end cap screws Designed for wall mounting the top rail ECS1 screws sold separately 

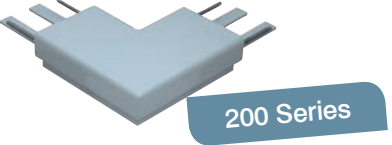
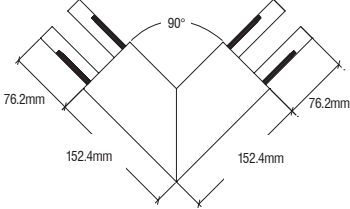
CRL 90 Degree Horizontal Corners

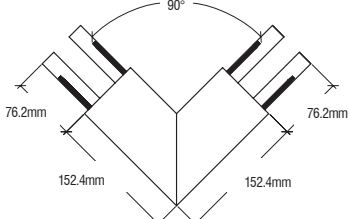
<p>2TRHXX</p> 	<p>CRL 200 Series 90 Degree Horizontal Corners</p> <ul style="list-style-type: none"> Welded and finished Matches shape of top rail Includes aluminium connector splice plates 6005 Alloy aluminium/T5 temper Custom angle corners also available 
<p>3TRHXX</p> 	<p>CRL 300 Series 90 Degree Horizontal Corners</p> <ul style="list-style-type: none"> Welded and finished Matches shape of top rail Includes aluminium connector splice plates 6005 Alloy aluminium/T5 temper Custom angle corners also available 

CRL 135 Degree Horizontal Corners

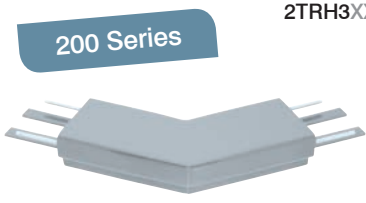
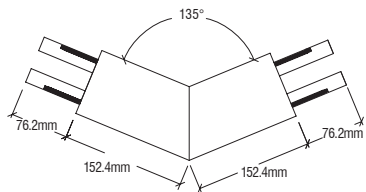
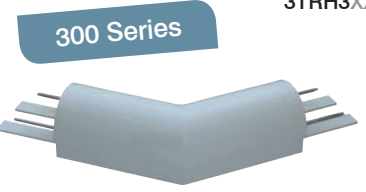
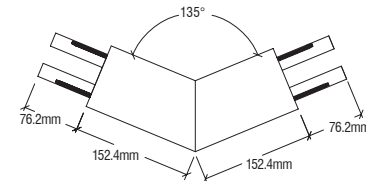
	CODE	DESCRIPTION	
 <p>200 Series</p>	2TRH3XX	CRL 200 Series 135 Degree Horizontal Corners <ul style="list-style-type: none"> • Welded and finished • Matches shape of top rail • Includes aluminium connector splice plates • 6005 Alloy aluminium/T5 temper • Custom angle corners also available 	
 <p>300 Series</p>	3TRH3XX	CRL 300 Series 135 Degree Horizontal Corners <ul style="list-style-type: none"> • Welded and finished • Matches shape of top rail • Includes aluminium connector splice plates • 6005 Alloy aluminium/T5 temper • Custom angle corners also available 	

CRL Corner Brackets

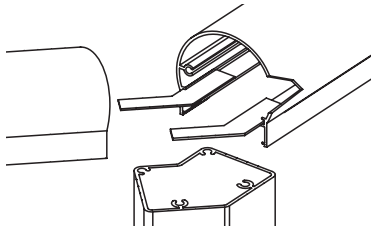
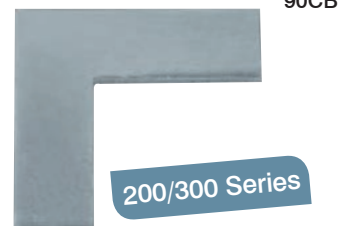
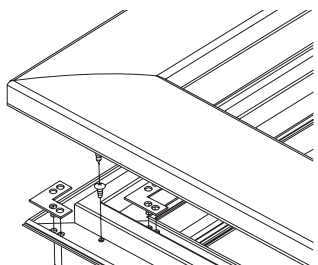
 <p>45CB</p> <p>200/300 Series</p>	135 Degree Corner Bracket <ul style="list-style-type: none"> • For use with 200 and 300 Series • Designed to fit underneath our top rails. • Brackets are held in place with four Cat. No. TEK1 self-tapping tek screws • Aluminium brackets are concealed under the top rail to connect corners. 	
 <p>90CB</p> <p>200/300 Series</p>	90 Degree Corner Bracket <ul style="list-style-type: none"> • For use with 200 and 300 Series • Designed to fit underneath our top rails. • Brackets are held in place with four cat. No. TEK1 self-tapping tek screws • Aluminium brackets are concealed under the top rail to connect corners. 	

CRL Splice Plates

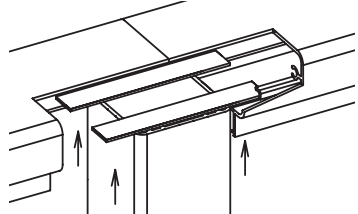



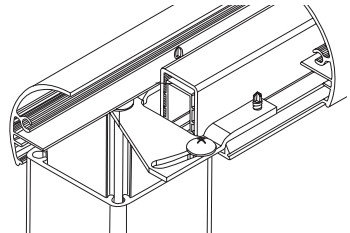

 <p>200/300 Series</p> <p>TCP1</p>	CRL Splice Plates for Rails <ul style="list-style-type: none"> • For use with 200 and 300 Series • Aluminium splice plates fit under top rail to splice top rails together over a post • Plates are held in place with two self-tapping screws (Cat. No. TEK1) • Two plates are required at each splice point 	
---	--	---

CRL Adjustable Fastening Plates

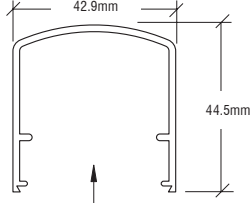
 <p>200/300 Series</p> <p>CB350L Left Hand Plate</p> <p>CB350R Right Hand Plate (not shown)</p> <p>CBS1 19mm Screw</p>	CRL Adjustable Fastening Plates for Top Rails <ul style="list-style-type: none"> • For use with 200 and 300 Series • Aluminium plates attach to top of vertical post then to top rail • No exposed screws design 	
---	--	---

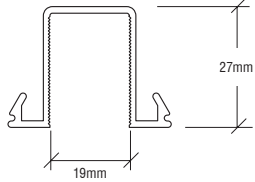
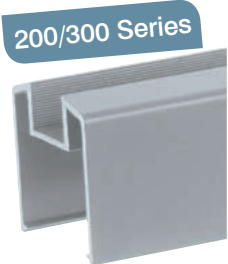
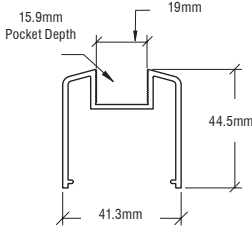
CRL Horizontal Mid Rail and Infill for Glass

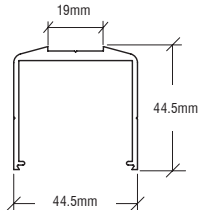
XX = Colour Code. Refer to page 45 for colour range and codes

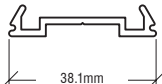
	CODE	DESCRIPTION	
	MR1XX	CRL Horizontal Mid-Rail <ul style="list-style-type: none"> • For use with 200 and 300 Series • Designed to accommodate 6mm to 12mm glass or 19mm square pickets. 6 and 10mm using gasket. 12mm glass when used with wet glaze method • Custom powder coat colours also available • Designed to be anchored between posts using RCB2 mounting blocks 	
	MR1FXX	CRL Horizontal Snap-In Infill for Glass <ul style="list-style-type: none"> • Designed to accommodate 6mm to 12mm glass. 6 and 10mm using gasket. 12mm glass when used with wet glaze method • Designed to be anchored between posts using RCB2 mounting blocks • Custom powder coat colours also available • Snaps in from the underside of the horizontal mid-rail 	
CRL Bottom Rails			
	BRGLSXX	CRL Bottom Glass Rail <ul style="list-style-type: none"> • For use with 200 and 300 Series • Bottom rail designed to accommodate 6 to 12mm toughened glass. 6 and 10mm using gasket. 12mm glass when used with wet glaze method 	
	BRPKTXX	CRL Bottom Picket Rail <ul style="list-style-type: none"> • For use with 200 and 300 Series • Designed to accommodate 19mm square or round pickets • Optional bottom rail filler available 	
	BRF241XX	CRL Standard Bottom Rail Filler <ul style="list-style-type: none"> • Snaps in to conceal the underside of bottom rails and create a flush look • Works with bottom rail for glass or bottom rail for pickets • Also works with horizontal mid rails 	

CRL Intermediate Bottom Support



1BSXX

CRL Intermediate Bottom Support

- For use with all of our aluminium railings
- Connects to bottom rail with two self-tapping screws (Cat. No. TEK1)

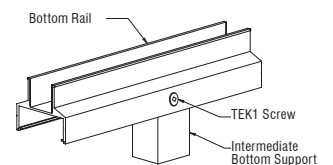

CRL Rail Connecting Blocks & Screws

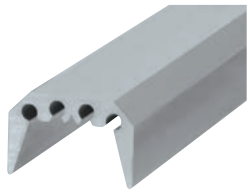

200/300 Series

CODE

RCB2
25.4mm

RCB212
305mm

RCB2241
6.12m

DESCRIPTION

CRL Rail Connecting Blocks

- For use with 200 and 300 Series
- Designed for use when installing bottom rails
- Three standard lengths available

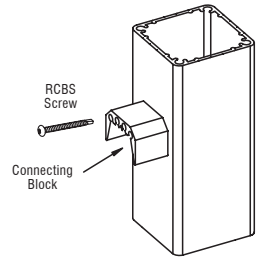

RCBS

Rail Connecting Block Screw



9502

Square insert bit for screw



TEK1

Rail Fastening Screw



ECS1

Endcap Screws

CRL Rail Connecting Block & CRL TEK Screws

- For all CRL railings
- Self-tapping
- Stainless steel

CRL Square Posts & Kits

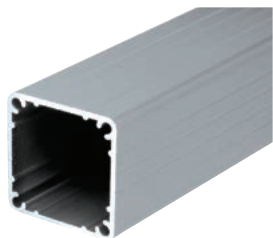

P241XX

6.12m Stock Length

CRL Posts Only

- 60.3mm square
- Use for 180 degree, 90 degree or end posts
- 6005 Alloy aluminium/T5 temper

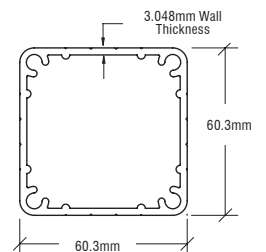

CRL 90 Degree Fascia Mount Brackets

XX = Colour Code. Refer to page 45 for colour range and codes

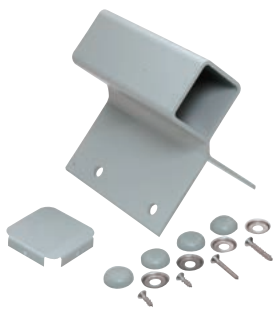
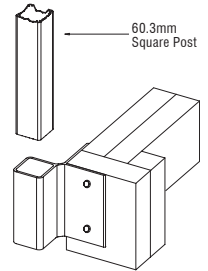

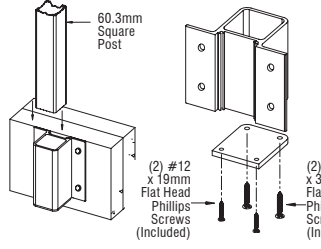

CODE	DESCRIPTION
 <p>FB2XX</p> <p>Works with CRL Posts Cat. No. P241</p>	<p>CRL 90 Degree Fascia Mount Brackets</p> <ul style="list-style-type: none"> Specifically designed for outside 90 degree fascia mount installations Works with almost any deck For 200 series only 

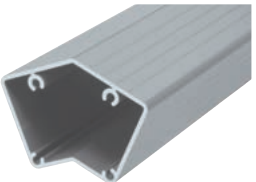
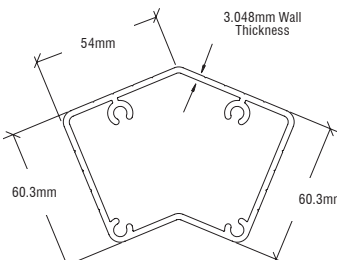
 <p>FB1XX</p> <p>Works with CRL Posts Cat. No. P241</p>	<p>CRL Fascia Mount Brackets</p> <ul style="list-style-type: none"> Black, white and silver finishes available from stock - custom finishes also available. For details visit crlaurence.co.uk Available to Match All CRL Aluminium Railings Using Our 60.3mm square aluminium posts 
---	---





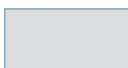

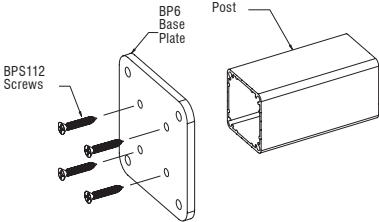

CRL 135 Degree Surface Mount Posts & Kits

 <p>P5241XX 6.12m Stock Length</p>	<p>CRL 135 Degree Posts Only</p> <ul style="list-style-type: none"> Stock length you can cut to the needed size Black, white and silver finishes available from stock - custom finishes also available. For details visit crlaurence.co.uk Surface mount only 
---	---

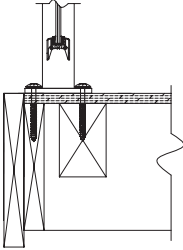
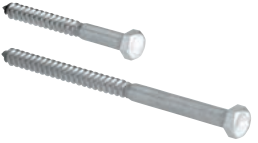
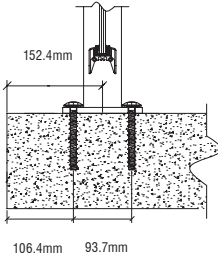
CRL Touch up Paint

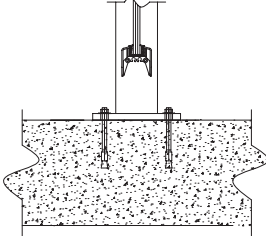
 <p>SP8XX</p>	<p>CRL Touch-Up Paint</p> <ul style="list-style-type: none"> Matches seven CRL powder paint colours Used to cover scratches or bare metal ends Stock colours shown below. Other colours available for custom orders. <div style="display: flex; justify-content: space-around; align-items: center;"> <div style="text-align: center;">  <p>Sky White - Gloss</p> </div> <div style="text-align: center;">  <p>Black - Matte</p> </div> <div style="text-align: center;">  <p>Silver - Metallic</p> </div> </div> 
---	---

CRL Screws, Bolts & Anchors

CODE	DESCRIPTION	
BPS112 Base Plate Screw	CRL Base Plate Screws <ul style="list-style-type: none"> • For use with all square base plates • Stainless steel 	
		
LB350 Lag Bolt 9.5mm x 88.9mm	CRL Lag Bolts <ul style="list-style-type: none"> • Attach vertical posts to a wooden substrate • Stainless steel 	
		
LB600 Lag Bolt 9.5mm x 152.4mm		
WBA14X3 Wedge Bolt Anchor 6.3mm x 76.2mm	CRL Wedge Bolt Concrete Anchors <ul style="list-style-type: none"> • To attach vertical posts to concrete substrate • Heat treated carbon steel 	
		
WBA38X4 Wedge Bolt Anchor 9.5mm x 101.6mm		
CA325 Stainless Steel Anchor 6.3mm x 82.5mm	CRL Stainless Steel Concrete Anchors <ul style="list-style-type: none"> • To attach vertical posts to concrete substrate 	
		
RCBS Rail Connecting Block Screw #10 x 50.8mm	CRL Stainless Steel Self Drilling Railing Screws	
		
TEK1 Rail Fastening Screw #8 x 19mm		
		
9502 Square Insert Bit for Screw		
		
ECS1 End Cap Screws		

CRL Standard Square Base Plates

XX = Colour Code. Refer to page 45 for colour range and codes

CODE

DESCRIPTION

BP5XX



CRL Square Base Plate

- For use with all standard railings
- For 60.3mm square aluminium posts
- Complete with moisture barrier gasket

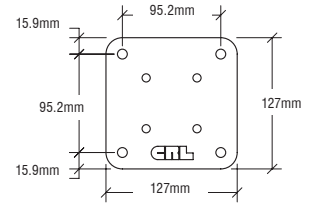

BP05XX



CRL Offset Base Plate

- For use with all standard railings
- For 60.3mm square aluminium posts
- Complete with moisture barrier gasket

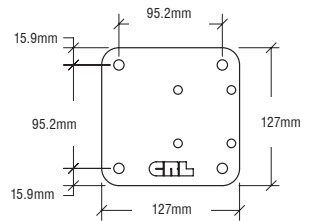

BPG1BL
127mm x 127mm

BPG2BL
152mm x 152mm

BPG3BL
165.1mm x 165.1mm



CRL Moisture Barrier Gaskets for Square Base Plates

- Protects metal base plates from moisture in concrete
- Three sizes available
- For aluminium railings and windscreens
- 3.2mm thick

PST5
Core Mount
***PST5BP**
Surface Mount



CRL ARS Stanchions

- Designed for all series of CRL aluminium railings using our 60.3mm square aluminium posts
- Stainless steel
- Stanchion height of 254mm

*Specify powder coat colour when ordering.

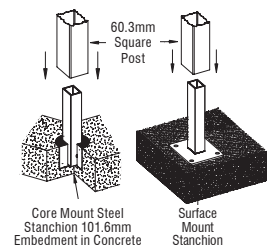

CVR5XX

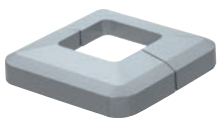



CRL Aluminium Base Plate Cover

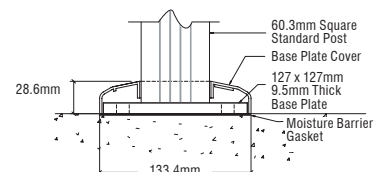



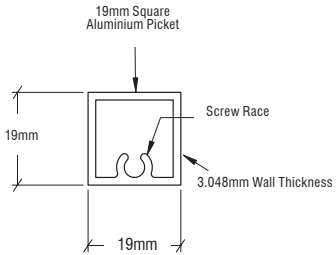

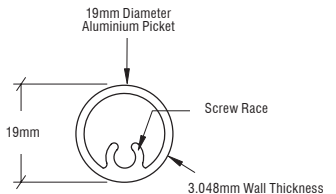
- Designed for use with our standard 60.3mm square aluminium posts and 127mm square base plates
- For surface or core mounted installations
- Custom powder coat colours also available



CRL Pickets & Picket Panels

	CODE	DESCRIPTION	
	PKTS241XX	CRL Square Pickets <ul style="list-style-type: none"> • 6.12m extrusions you cut to required lengths • Easy to install design <p>Use with PKTS2 Picket Screws</p>	
	PKTR241XX	CRL Round Pickets <ul style="list-style-type: none"> • 6.12m extrusions you cut to required lengths • Easy to install design <p>Use with PKTS2 Picket Screws</p>	

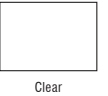
CRL Sealants & Cements

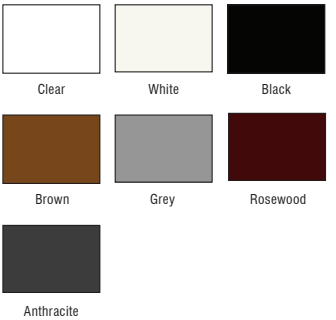
	KWX25 11.3kg KWX50 22.7kg	CRL Kwixset® Expanding Cement <ul style="list-style-type: none"> • Kwixset® for exterior and interior applications • Great for setting core mount stanchions for vertical posts • Expand as it sets • Fast setting, it will not shrink or crack when used as directed • Just mix with water to KWX50 • No shrinking and cracking 	
	EU33SC Clear	CRL Acetic Cure Silicone Sealant <ul style="list-style-type: none"> • Acetic cure formula • Plastic cartridges with screw-on nozzles • High modulus • 300ml cartridge • 12 per case • Special countertop display box 	
	EUCCS	CRL Crystal Clear Silicone <ul style="list-style-type: none"> • High clarity when cured • Applications include shower enclosures and speciality glass assemblies • 310ml cartridge • 12 per case • Special countertop display box 	
	EURTV408C Clear EURTV408W White EURTV408BL Black EURTV408BR Brown EURTV408G Grey EURTV408A Anthracite EURTV408R Rosewood	CRL Neutral Cure Low Modulus Silicone <ul style="list-style-type: none"> • Low odour, neutral cure formula • Compatible with insulating glass glazing • Excellent adhesion to most surfaces • Low modulus • High grade formula - low shrinkage • 300ml cartridge, 12 per case • Special countertop display box • Conforms to ISO 11600 	

XX = Colour Code. Refer to page 45 for colour range and codes





Aluminium Windscreen System (AWS)





The AWS Aluminium Windscreen System was developed to provide an attractive, maintenance-free glass wall. All AWS Systems can be used in conjunction with a concrete slab, block wall or individual footings.

Visual Appeal The Homeowner will love the clean look of this wall and the virtually unobstructed view it provides.

Noise Reduction The AWS System is superbly suited as a sound wall along busy streets and highways. Our system provides a much higher sound transmission rating than conventional fencing.

Maintenance The AWS System is low maintenance. All components are specially coated to prevent corrosion and ensure that the homeowner will be satisfied for many years.

Flexibility The AWS System adapts to a wide variety of terrain and wall designs. The system is ideal for pool areas, decks and balcony applications.

Integrity The AWS System has been designed to provide a safe, transparent fence during high wind conditions. All glass installed must be fully toughened to meet all safety requirements and building codes.

For more information call FREE on
00 800 0421 6144

f: 00 800 0262 3299

CRL AWS Aluminium Windscreen System



- **Steel embedment keeps aluminium posts out of contact with concrete, and adds structural strength**
- **Ready to install**
- **Low maintenance with special coating to prevent corrosion**
- **Custom colours also available**

Unlike other glass wind wall systems, the AWS Aluminium Windscreen System keeps all aluminium out of contact with concrete.

The AWS System was designed to be a wind wall that is very aesthetically pleasing. Because of the great design and the interaction with the steel insert, AWS has enhanced structural properties, allowing for increased height and span capabilities.

Available Post Configurations

50.8 x 66.7mm Rectangular Aluminium Windscreen Post Profiles



180 Degree Centre/
End Post Kits

90 Degree
Post Kits

135 Degree
Post Kits

76.2mm Round Aluminium Windscreen Post Profiles



180 Degree Centre/
End Post Kits

90 Degree
Post Kits

135 Degree
Post Kits

Stock and custom finishes are shown below with their colour codes. Add the chosen colour code to a Cat No to complete your product code.

Note: Colours shown are representative only, and may vary slightly from actual gloss, colour, and texture. If colour match is critical, please contact Technical Sales for additional information.

Stocked Finishes

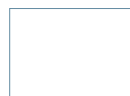

Sky White - Gloss
CODE W



Black - Matte
CODE BL

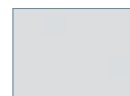

Silver - Metallic
CODE S

Custom finishes (available on request)



Oyster White - Gloss
CODE OW



Bronze - Matte
CODE BRZ

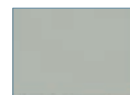

Agate Grey - Gloss
CODE AGY



Beige Grey - Gloss
CODE BGY

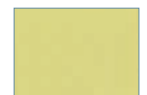

Unfinished Chromate
CODE CRM

Additional Colour Options

- A variety of textured and performance enhanced powder coat paint systems
- Custom colour matching
- All paint systems will be applied over state-of-the-art chromate pre-treatment

CRL AWS Aluminium Windscreen System Mounting Options



Unlike other glass wind wall systems, the AWS Aluminium Windscreen System keeps all aluminium out of contact with concrete. The lime in concrete is very corrosive to aluminium, and over time will degrade the physical properties of the components. The AWS System utilises a painted steel embedment that supports the vertical post and eliminates the possibility of damaging corrosion.

An added benefit of the steel embedment is that the contractor can install the steel components early in the construction process, then install the painted aluminium post later when the chances of damage by other tradesmen are greatly reduced. These are strong attributes of the AWS System, and have a real value to the builder and homeowner.

Typical Mounting Options

Core Mounted Installation for a Concrete Slab

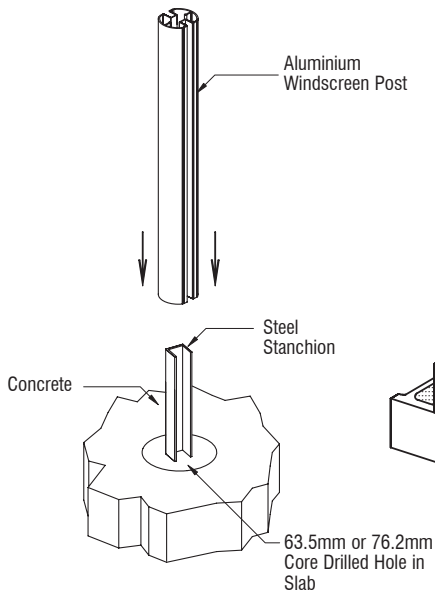

Core Mounted Installation for CMU Block Walls

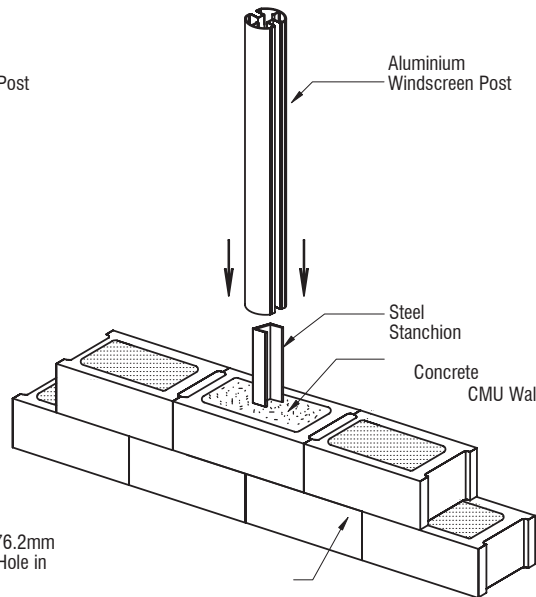

Surface Mounted Installation for a Concrete Slab

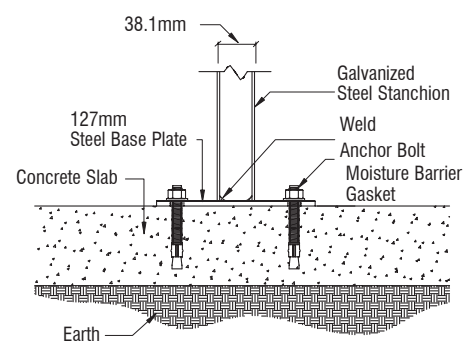
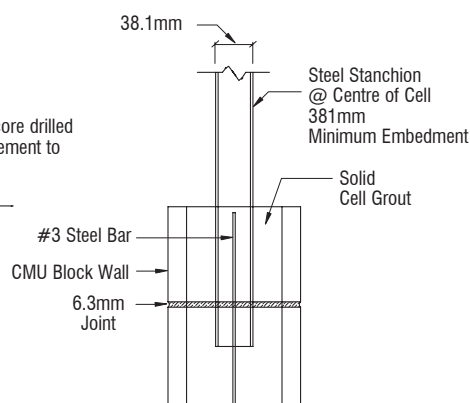
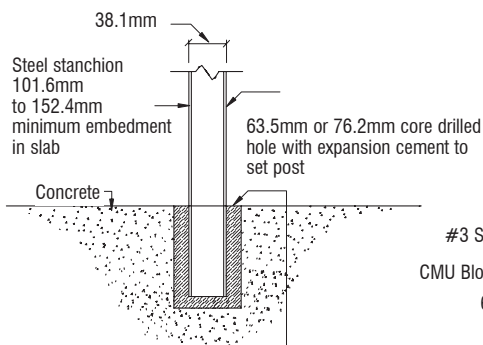
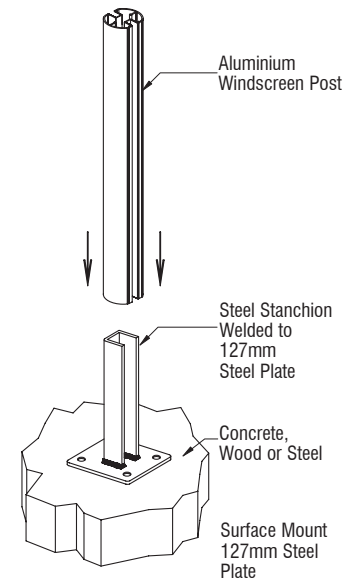

Basic Installation Instructions

- 1.**
- Core mount or surface mount the Steel Stanchions, starting with the End and Corner Posts first.
 - Then run a straight line between your End Posts and/or Corner Posts before you set the Intermediate Posts.
 - Be sure the Stanchions are plumb and level.
 - Note: When surface mounting to concrete, brick, masonry, or stucco make sure to install the Moisture Barrier Gasket between the bottom plate and substrate to prevent metal corrosion.

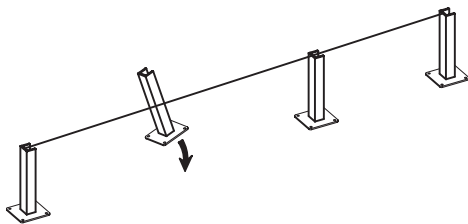

- 2a.**
- Once the Steel Stanchions are installed, apply CRL 95C Silicone to the Stanchion before mounting the Post into place.
 - If you are installing a Surface Mount Bottom Rail, measure and cut to the desired size, then install the Surface Mount Bottom Rail onto the substrate using CRL 95C Silicone.
 - Note: Surface Mount Bottom Rails are optional when installing the AWS System.

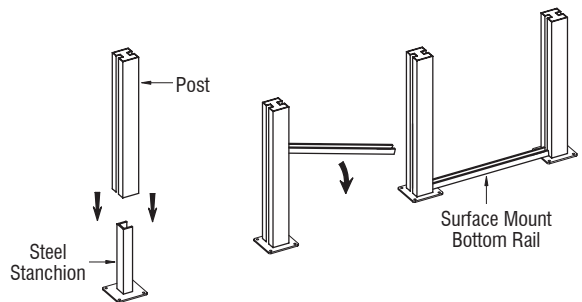

- 2b.**
- If you are installing an Elevated Bottom Rail, Rail Connecting Blocks must be installed first.
 - Install the Rail Connecting Blocks onto the Post using Cat. No. RCBS Self Tapping Screws. These Blocks are used to support the Bottom Rail.
 - NOTE: Elevated Bottom Rails are optional when installing the AWS System.

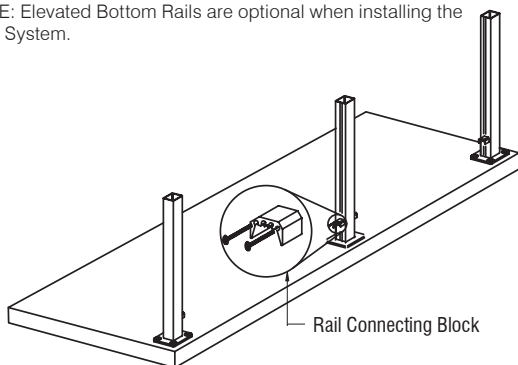

- 2c.**
- Cut Elevated Bottom Rail to length. Mount the Bottom Rail onto the Blocks and secure with Cat. No. TEK1 Tek Screws.

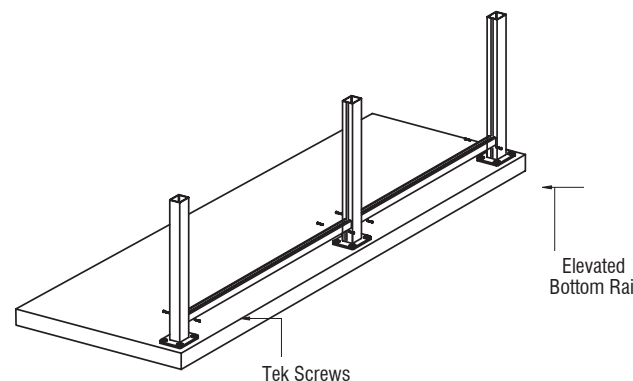

- 3.**
- When installing the glass panels, make sure the rigid vinyl is installed into the glass pocket before installing the panels.
 - Slide the glass panels down from the top of the Post. Make sure the vinyl is lubricated to protect the vinyl from damage during installation.

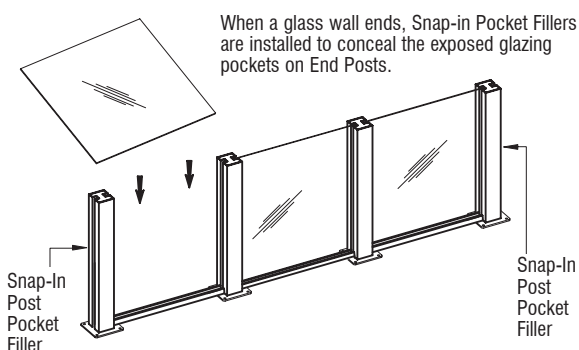

- 4.**
- Install Post Caps with CRL 95C Silicone.
 - To protect the glass from debris over time, use CAT. No. N56025 Surface Protector to seal the glass.

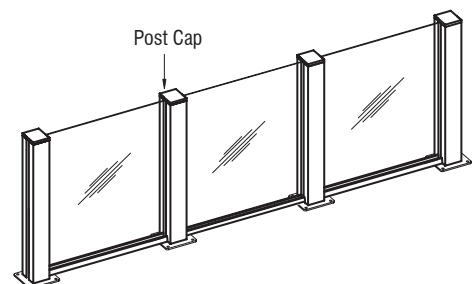

CODE DESCRIPTION



SP194XX 6.12m

CRL AWS 50.8 x 66.7mm Rectangular 180 Degree Centre or End Post Only

- Ready to install
- Low maintenance with special coating to prevent corrosion
- 6.12m stock length so you can cut custom heights
- Custom colours also available

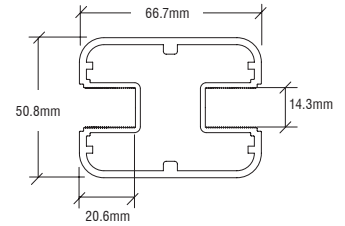

CRL AWS Rectangular 90 Degree Corner Posts & Kits



SP9194XX 6.12m

CRL AWS 50.8 x 66.7mm Rectangular 90 Degree Corner Post Only

- Ready to install
- Low maintenance with special coating to prevent corrosion
- 6.12m stock length so you can cut custom heights
- Custom colours also available

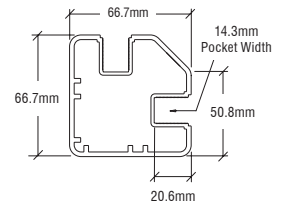

CRL AWS Rectangular 135 Degree Corner Posts & Kits

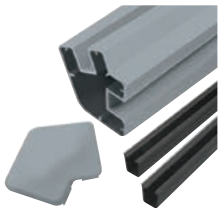

S365KXX 914mm

S485KXX 1219mm

S605KXX 1524mm

S725KXX 1829mm

CRL AWS 50.8 x 66.7mm Rectangular 135 Degree Post Kits

- Standard kits include post, top cap, and vinyl
- Custom colours available upon request
- Accommodates 6 to 10mm glass dry glazed with vinyl
- Accommodates 12mm glass wet glazed

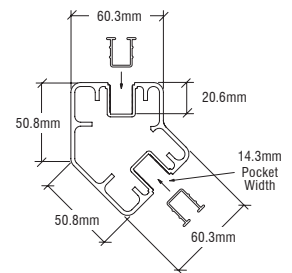

SP2541XX 6.12m

CRL AWS 50.8 x 66.7mm Rectangular 135 Degree Posts Only

- Ready to install
- Low maintenance with special coating to prevent corrosion
- 6.12m stock length so you can cut custom heights
- Custom colours also available

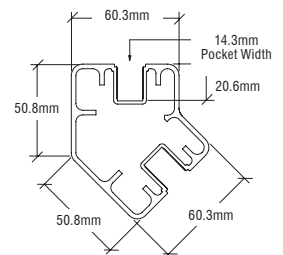

CRL AWS Rectangular Aluminium Windscreen System



- Great for pools, balconies, fencing, steps, slopes, and many other options
- Low maintenance with all components specially coated to prevent corrosion
- Will accommodate 6mm, 10mm with gasket, and 12mm wet set glazing
- Glazing vinyl available in black colour
- Designed and engineered to meet or exceed building codes

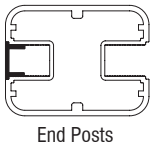

End Posts



Centre Posts

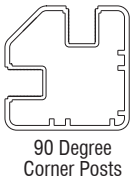



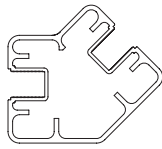

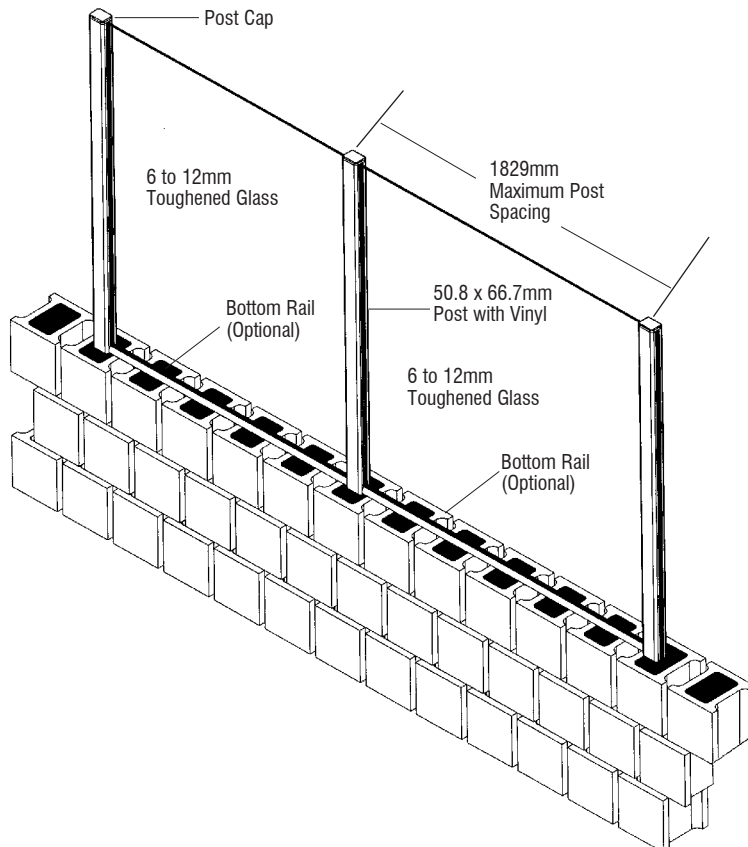
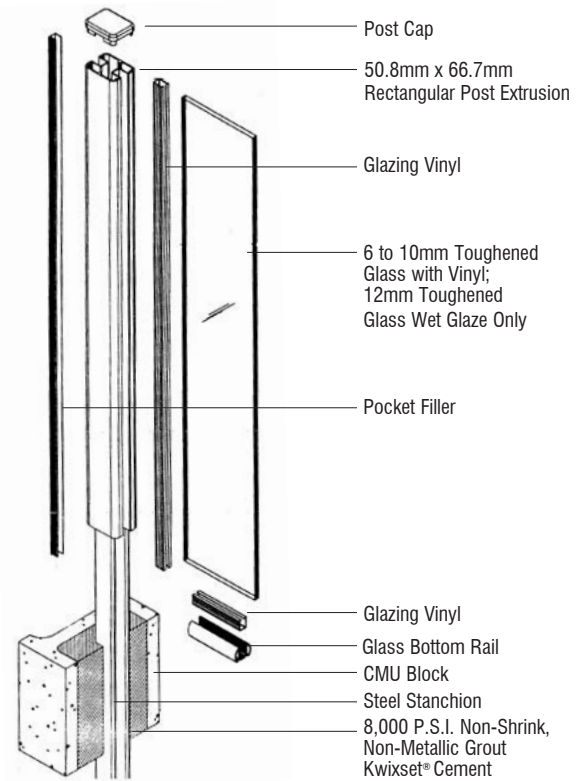

90 Degree Corner Posts



135 Degree Posts

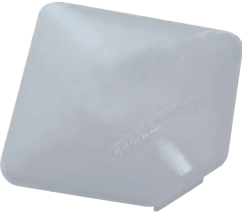

CRL AWS Rectangular Post Caps

CODE	DESCRIPTION
PC1EWXX	Caps for 180 Degree Centre Posts or End Posts <ul style="list-style-type: none">• Ready to install• Attaches to post using CRL's EURTV408BL silicone
	
PC135SXX	Caps for 135 Degree Posts <ul style="list-style-type: none">• Ready to install• Attaches to post using CRL's EURTV408BL silicone
	
PC9SXX	Caps for 90 Degree Corner Posts <ul style="list-style-type: none">• Ready to install• Attaches to post using CRL's EURTV408BL silicone
	

CRL AWS Round 180 Degree Posts & Kits

XX = Colour Code. Refer to page 64 for colour range and codes

CODE DESCRIPTION



RP194XX 6.12m

CRL AWS 76.2mm Diameter Round 180 Degree Centre or End Post Only

- Low maintenance
- Special coating to prevent corrosion
- 6.12m stock length so you can cut custom heights
- Custom colours also available

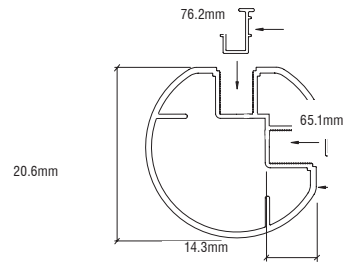

CRL AWS Round 90 Degree Corner Posts & Kits



RP9194XX 6.12m

CRL AWS 76.2mm Diameter Round 90 Degree Corner Post Only

- Ready to install
- Low maintenance
- Special coating to prevent corrosion
- 6.12m stock length so you can cut custom heights
- Custom colours also available

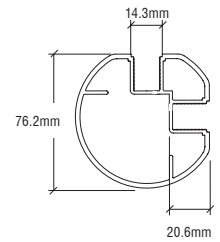

CRL AWS Round 135 Degree Corner Posts & Kits



RP5241 6.12m

CRL AWS 76.2mm Diameter Round 135 Degree Post Only

- Ready to install
- Low maintenance
- Special coating to prevent corrosion
- 6.12m stock length so you can cut custom heights
- Custom colours also available

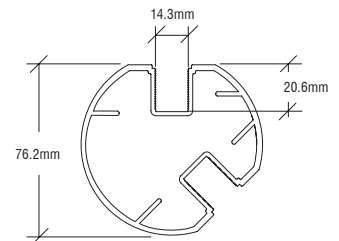

CRL AWS Round Aluminium Windscreen System







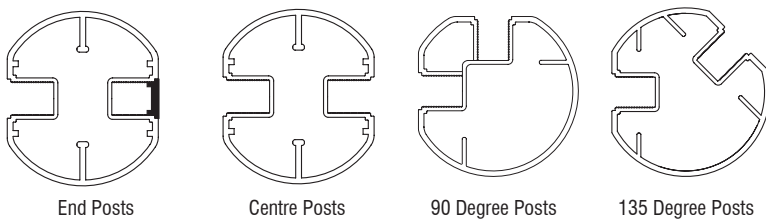
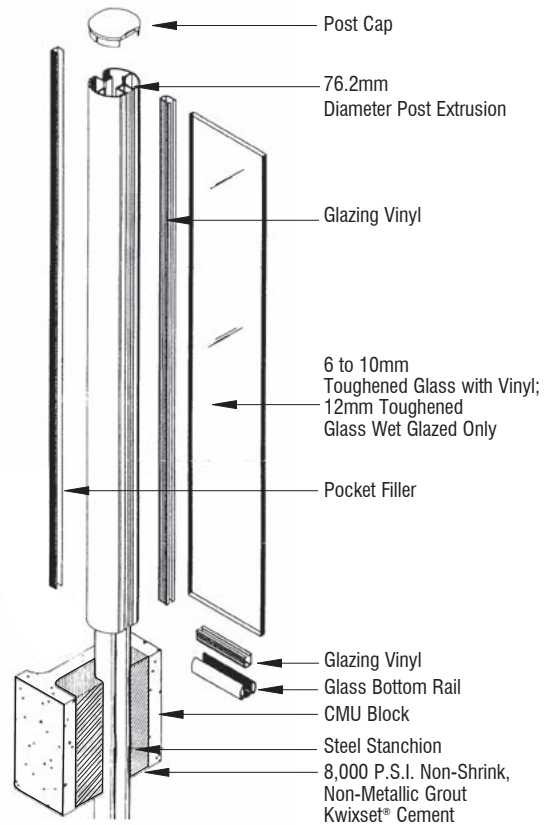
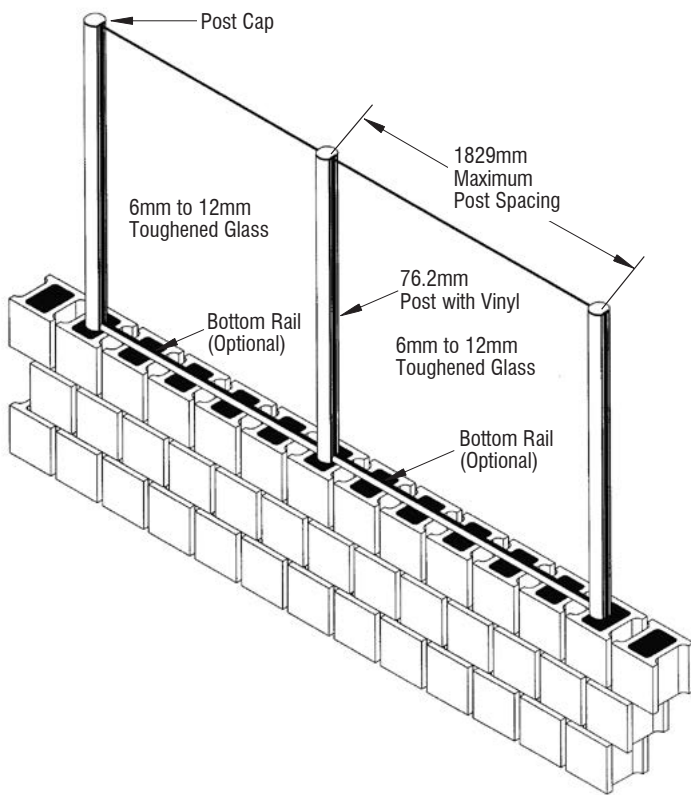

NOTE: Not for use as a guard rail.

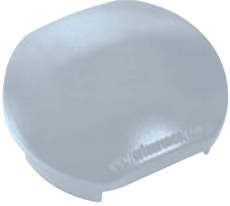
- 76.2mm diameter aluminium windscreen system for pools, balconies, fencing, steps, slopes, and many other options
- Low maintenance with all components specially coated to prevent corrosion
- Will accommodate 6mm, 10mm using gasket and 12mm wet set glazing
- 914mm, 1219mm, 1524mm, and 1829mm standard heights. 6.12m stock lengths available
- Glazing vinyl available in black colour
- Designed and engineered to meet or exceed building codes



CRL AWS Round Post Caps

	CODE	DESCRIPTION	
	PC1RXX	Caps for 180 Degree Centre Posts or End Posts <ul style="list-style-type: none">• Ready to install	
	PC135RXX	Caps for 135 Degree Posts <ul style="list-style-type: none">• Ready to install	
	PC9RXX	Caps for 90 Degree Corner Posts <ul style="list-style-type: none">• Ready to install	

CRL AWS Stanchions

XX = Colour Code. Refer to page 64 for colour range and codes



CODE	DESCRIPTION
PST1 457mm height Grade 50 steel Posts up to 914mm high 3.2mm thick	CRL AWS Core Mount Stanchions <ul style="list-style-type: none"> Galvanized to prevent corrosion Available in four different sizes for round or rectangular windscreen posts Available in stainless steel for coastal installations Fits all of our rectangular or round aluminium posts
PST2 457mm height Grade 50 steel Posts up to 1219mm high 6.3mm thick	
PST3 762mm height Grade 50 steel Posts up to 1829mm high 6.3mm thick	
PST4 762mm height 304 Grade stainless steel Posts up to 1829mm high 3.2mm thick	
PST5 1067mm height Grade 50 steel Call for post height info 6.3mm thick	

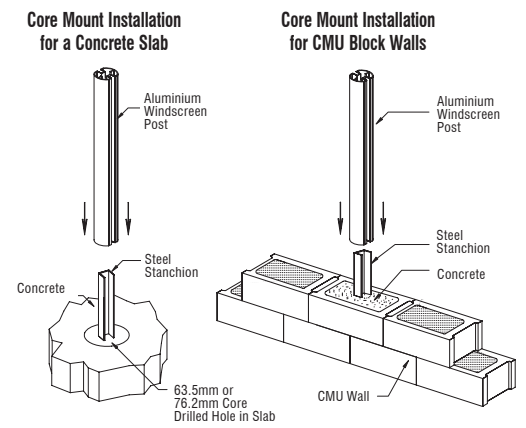

CRL AWS Welded Steel Surface Mount Stanchions

- Mounting bases available in seven standard colours, plus unfinished chromate to match AWS posts
- 90,135, and 180 degree bases are designed for concrete or steel installations
- Attaches to the post using our EURTV408BL silicone
- Galvanized and powder coated to prevent corrosion

Steel Stanchions for Post Heights up to 610mm (Stanchion height 305mm)

PSB1A	For 180° Round/Rectangular Centre/End
PSB2A	For 90° Round
PSB3A	For 90° Rectangular Posts
PSB4A	For 135° Round
PSB5A	For 135° Rectangular Posts
BPG1BL	Gasket

Steel Stanchions for Post Heights up to 1219mm (Stanchion height 762mm)

PSB1B	For 180° Round/Rectangular Centre/End
PSB2B	For 90° Round
PSB3B	For 90° Rectangular Posts
PSB4B	For 135° Round
PSB5B	For 135° Rectangular Posts
BPG1BL	Gasket

Steel Stanchions for Post Heights up to 1829mm (Stanchion height 762mm)

PSB1C	For 180° Round/Rectangular Centre/End
PSB2C	For 90° Round
PSB3C	For 90° Rectangular Posts
PSB4C	For 135° Round
PSB5C	For 135° Rectangular Posts
BPG2BL	Gasket

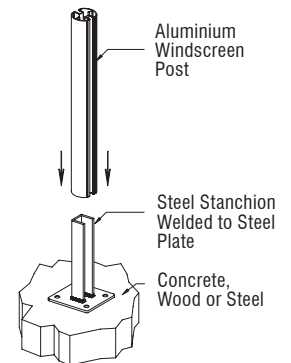

CRL AWS Post Pocket Fillers & Vinyls

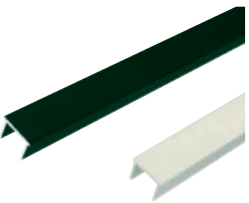
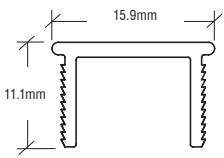
	CODE	DESCRIPTION	
	PF36 914mm	CRL AWS Windscreen Post Pocket Fillers <ul style="list-style-type: none"> • Ready to snap into glass pocket • Low maintenance • Special coating to prevent corrosion 	
	PF48 1219mm		
	PF60 1524mm		
	PF72 1829mm		
	PF194 6.12m		

	GV36BL 914mm	CRL AWS Rigid Glazing Vinyl <ul style="list-style-type: none"> • Black colour rigid push-in glazing vinyl for use with aluminium windscreen posts and bottom rails • Designed to accommodate 6 to 10mm toughened glazing 	
	GV48BL 1219mm		
	GV60BL 1524mm		
	GV72BL 1829mm		
	GV120BL 3.66m		

	BR36K 914mm	CRL AWS Bottom Rail Kits With Rigid Glazing Vinyl <ul style="list-style-type: none"> • Low maintenance • Special coating to prevent corrosion • Designed to accommodate 6mm and 10mm toughened glazing 	
	BR48K 1219mm		
	BR60K 1524mm		
	BR72K 1829mm		
	BR194 6.12m		

YOU MAY ALSO NEED
1" Vinyl Roller Tool CAT NO. VR04

CRL AWS Glass Rails & Fillers

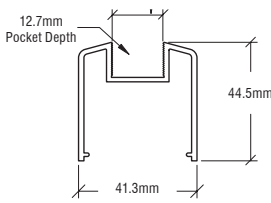
	BRGLSXX	CRL Intermediate Bottom Glass Rail <ul style="list-style-type: none"> • Bottom rail designed to accommodate 6mm to 12mm toughened glass • 6mm and 10mm using gasket. 12mm using wet glaze 	
---	---------	--	---

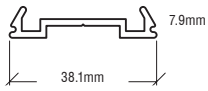
	BRF241XX	CRL Standard Bottom Rail Filler <ul style="list-style-type: none"> • Snaps in to conceal the underside of bottom rails and create a flush look 	
--	----------	--	---

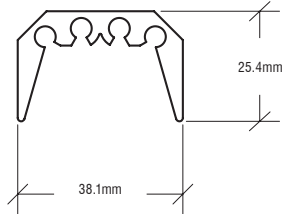
	RCB2 25.4mm	CRL Rail Connecting Blocks <ul style="list-style-type: none"> • For use when installing bottom rails • Three standard lengths available 	
	RCB212 305mm		
	RCB2241 6.12m		



XX = Colour Code. Refer to page 64 for colour range and codes



Structural Standoffs

- Complete with mounting plate
- For use with 12mm and 19mm monolithic toughened glass or 13.5mm and 21.5mm laminated toughened glass using DuPont™ SentryGlas® Interlayers
- Brushed or polished 316 grade stainless finishes available
- Designed for steel, wood, and concrete substrates

CRL's heavy-duty, point supported Glass Rail Standoff Fittings gives the installer more adjustment during installation for those tricky job site mounting conditions. The steel back plate can be fastened directly to steel, concrete, or wood substrates and shimmed as required with blocking.



	CODE	DESCRIPTION
	RS0B20BS	CRL Glass Rail Standoff Fittings Standard 51mm Diameter Caps
	RS0B20PS	<ul style="list-style-type: none"> • For use with 12mm and 19mm monolithic toughened glass or 13.5mm and 21.5mm laminated toughened glass using DuPont™ SentryGlas® Interlayers • Two 19mm diameter holes per fitting • Full engineering data available at crlaurence.co.uk
	RS0B25BS	CRL Glass Rail Standoff Fittings Standard 60mm Diameter Caps
	RS0B25PS	<ul style="list-style-type: none"> • For use with 12mm and 19mm monolithic toughened glass or 13.5mm and 21.5mm laminated toughened glass using DuPont™ SentryGlas® Interlayers • Two 19mm diameter holes per fitting • Full engineering data available at crlaurence.co.uk



CRL Heavy Duty Standoffs

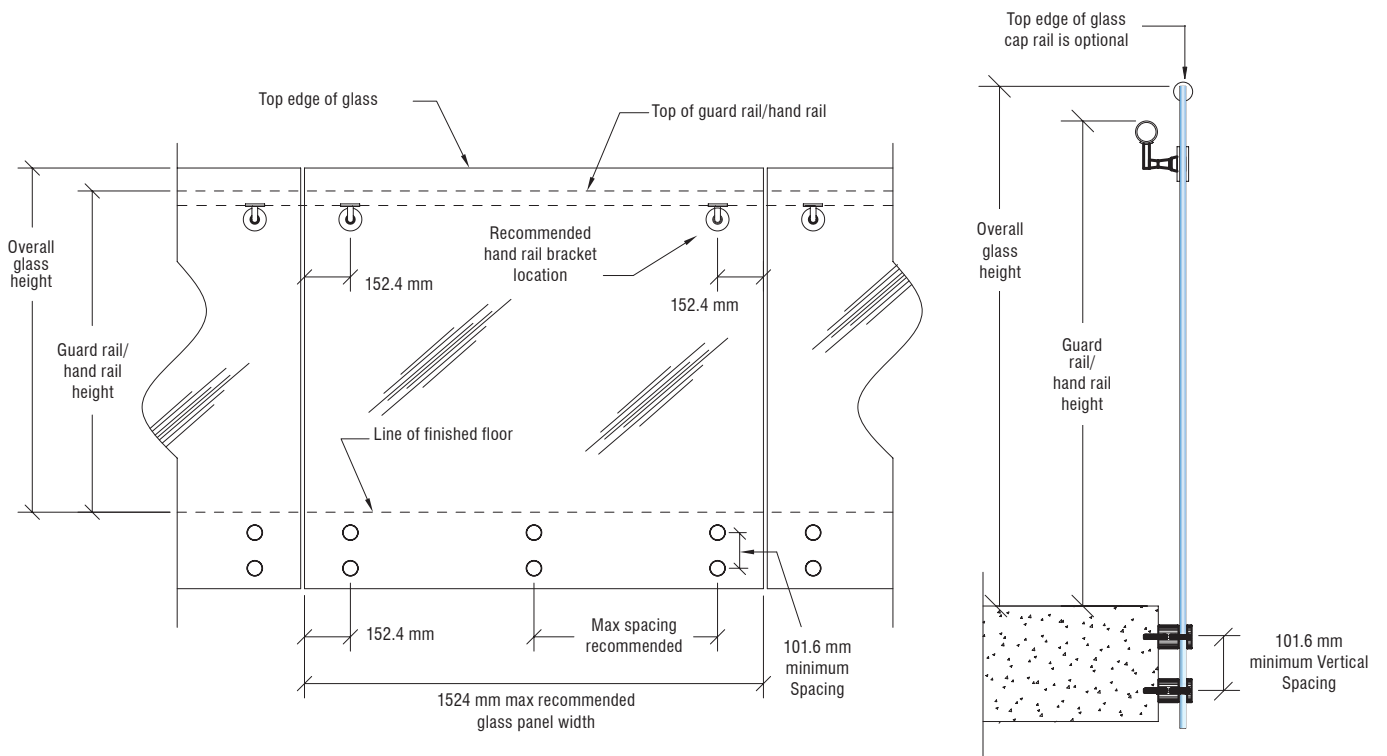

CRL Langle Standoffs

CRL Langle adjustable standoff has been specifically developed to be installed on rough, self-supporting substructures like concrete or stone. It is perfectly suited for the installation of glass facades as the model with a 60 mm diameter is optimal for the fastening of glass balustrades.

The adjustable standoff offers all necessary adjustments, whether horizontal or vertical as well as horizontal offset adjustments.

DESCRIPTION



CRL Langle Fix Standoffs

Consisting of:

- 1 flat cap
- 1 spacer
- 2 EPDM
- 1 EPDM

Material:

AISI 304 grade stainless steel

Salt Spray tested to 1000h NSS (DIN EN ISO 12944). Rating according to DIN EN ISO 4628-2 and 4628-3

Tested to DIN 18003-3



CODE	Diameter	Wall-Glass	Stud Bolt	Glass Thickness	Cut Out
RS0B45BS	Ø 45 mm	30 mm	M10x70	8 bis 20 mm	Ø 22 mm
RS0B60BS	Ø 60 mm	30 mm	M10x70	10 bis 24 mm	Ø 26 mm



CRL Langle Adjustable Standoffs

Consisting of:

- 1 flat cap
- 1 spacer
- 1 fixing disc
- 2 EPDM washers, 2 EPDM sleeve, 2 stud bolts M10 (application depending on glass thickness)

Material:

AISI 304 grade stainless steel

Salt Spray tested to DIN EN ISO 4628-2 and 4628-3

Tested to DIN EN ISO 18003-3

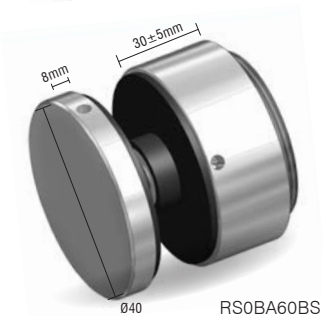

CODE	Diameter	Wall-Glass	Stud Bolt	Glass Thickness	Cut Out
RS0BA45BS	Ø 45 mm	25 - 35 mm	M10x30 M10x35	16 bis 20 mm 24 mm	Ø 22 mm Ø 22 mm
RS0BA60BS	Ø 60 mm	25 - 35 mm	M10x30 M10x35	16 - 20 mm 24 mm	Ø 26 mm Ø 26 mm



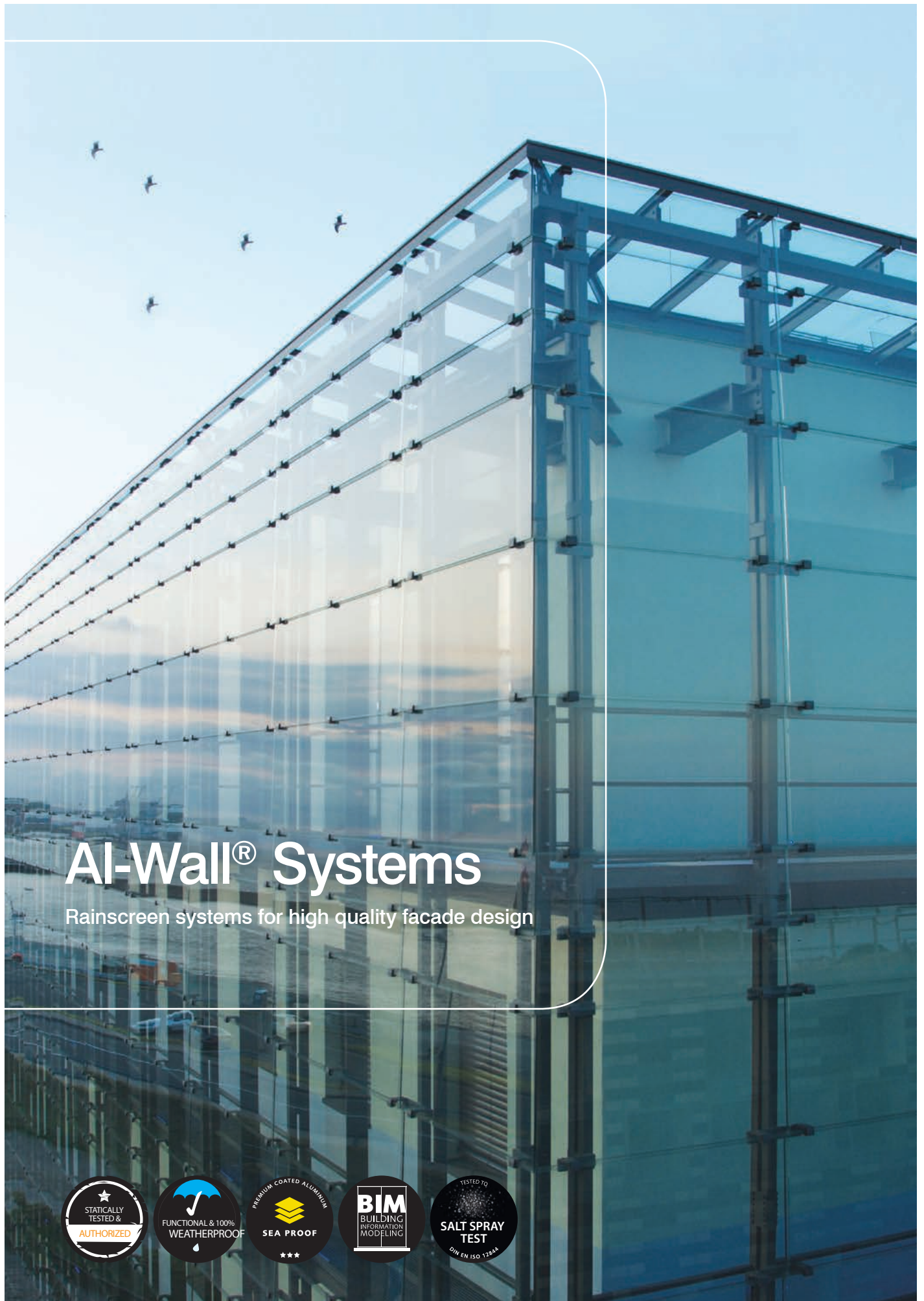

AI-Wall® Systems

Rainscreen systems for high quality facade design



- Creates a protective, modern envelop around new and old buildings
- Plane and imbricated glass facade options
- Quick and easy to install
- No glass cut outs necessary

DESCRIPTION

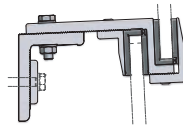
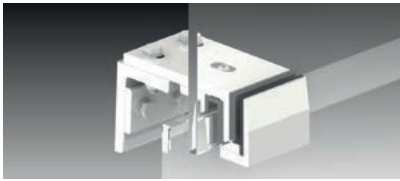

CRL AI-Wall®

- Horizontally imbricated
- No cutouts necessary
- Driving rain proof
- For use with 6mm to 19mm monolithic or laminated toughened glass

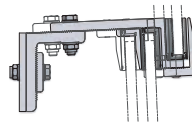

CRL AI-Wall® DS

- Horizontally and vertically imbricated
- Driving rain proof
- Parallel or laterally sloped imbrication
- For use with 6mm to 19mm monolithic or laminated toughened glass

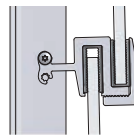

CRL AI-Wall® Light

- Horizontally imbricated
- Effortless and quick installation
- Simple substructure
- For use with 6mm and 8mm monolithic or laminated toughened glass

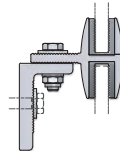

CRL AI-Wall® Flat

- For plane facades
- Safe glass installation without tools
- Minimum clearance from 8mm on
- For use with 8mm, 10mm, 12 mm and 16mm monolithic or laminated toughened glass



CRL AI-Wall® Flat Lors

- For plane facades
- Low structural depth
- Safe glass installation without tools
- For use with 8mm, 10mm, 12mm and 16mm monolithic or laminated toughened glass

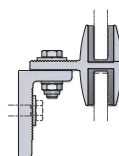

CRL AI-Wall® Flat Verso

- For plane facades
- Easy and safe glass installation without tools from the inside
- For use with 12mm and 16mm monolithic and laminated toughened glass

CRL Regular Spider Fixings



Regular Fittings - up to 12mm Glass

Grade 316 Stainless steel

CODE

DESCRIPTION



FMR1BS
Brushed Stainless

FMR1PS
Polished Stainless

CRL Single Arm Regular Duty Wall/Fin Mount Fitting

- For use with glass up to 12mm
- Complete with hardware to mount to wall or structural fin
- 316 stainless steel



**REGULAR
FIN
MOUNT**

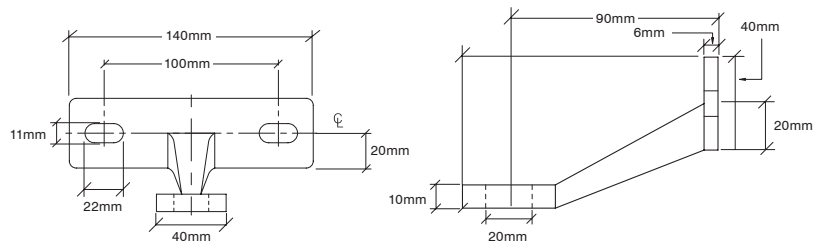
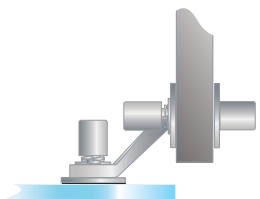

Glass attachments must be ordered separately (see page 89)



CODE

DESCRIPTION



FMR1LHBS
Brushed Stainless

FMR1LHPS
Polished Stainless

CRL Left Hand Single Arm Regular Duty Wall/Fin Mount Fitting

- For use with glass up to 12mm
- Complete with hardware to mount to wall or structural fin
- 316 stainless steel

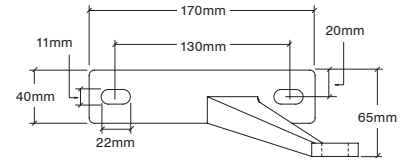
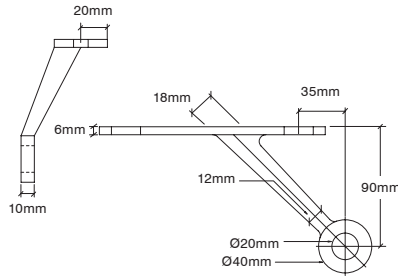
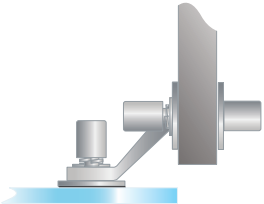

FMR1RHBS
Brushed Stainless

FMR1RHPS
Polished Stainless

CRL Right Hand Single Arm Regular Duty Wall/Fin Mount Fitting

- For use with glass up to 12mm
- Complete with hardware to mount to wall or structural fin
- 316 stainless steel

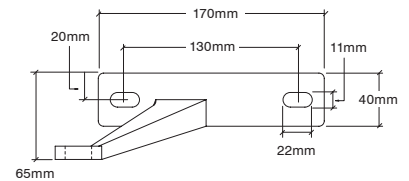
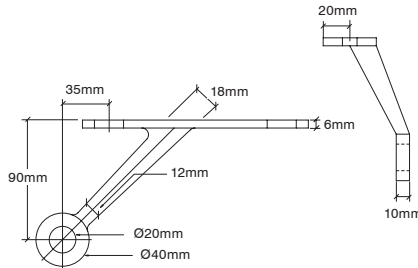
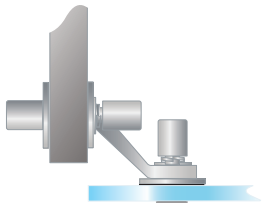

FMR2BS
Brushed Stainless

FMR2PS
Polished Stainless

CRL Double Arm Regular Duty Wall/Fin Mount Fitting

- For use with glass up to 12mm
- Complete with hardware to mount to wall or structural fin
- 316 stainless steel

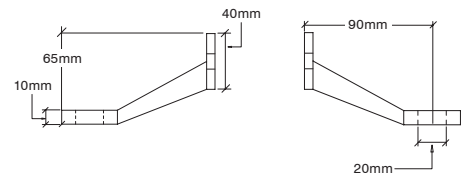
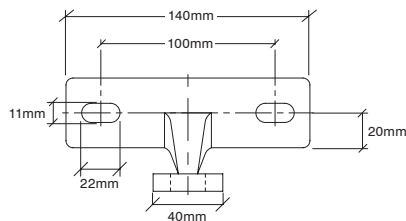
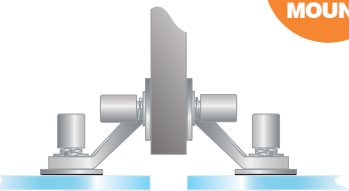

CRL Regular Spider Fixings

Grade 316 Stainless steel

CODE

DESCRIPTION



FMR2VBS
Brushed Stainless

FMR2VPS
Polished Stainless

CRL Double Arm "V" Regular Duty Wall/Fin Mount Fitting

- For use with glass up to 12mm
- Complete with hardware to mount to wall or structural fin
- 316 stainless steel

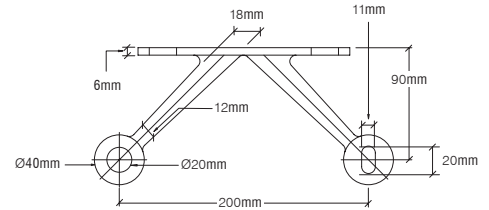
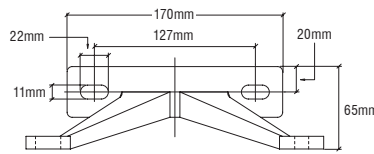
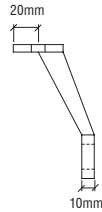
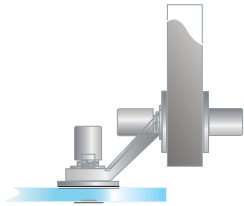

FMR4BS
Brushed Stainless

FMR4PS
Polished Stainless

CRL Four Arm "V" Regular Duty Wall/Fin Mount Fitting

- For use with glass up to 12mm
- Complete with hardware to mount to wall or structural fin
- 316 stainless steel

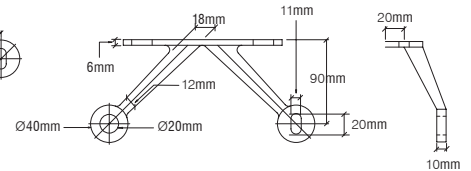
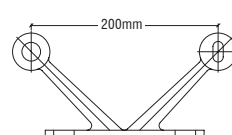
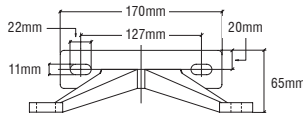

PMR1BS
Brushed Stainless

PMR1PS
Polished Stainless

CRL Single Arm Regular Duty Post Mount Fitting

- For use with glass up to 12mm
- Complete with hardware to mount to post or column
- 316 stainless steel

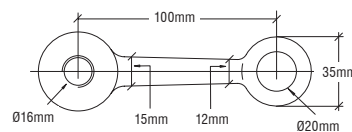
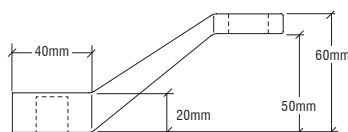
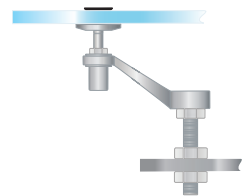

Glass attachments must be ordered separately (see page 89)



CODE

DESCRIPTION



PMR1LBS
Brushed Stainless

PMR1LPS
Polished Stainless

CRL Single Long Arm Regular Duty Post Mount Fitting

- For use with glass up to 12mm
- Complete with hardware to mount to post or column
- 316 stainless steel

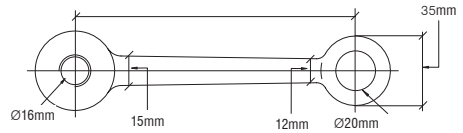
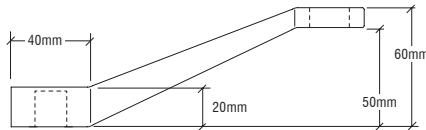
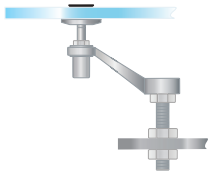

PMR2BS
Brushed Stainless

PMR2PS
Polished Stainless

CRL Double Arm Regular Duty Post Mount Fitting

- For use with glass up to 12mm
- Complete with hardware to mount to post or column
- 316 stainless steel

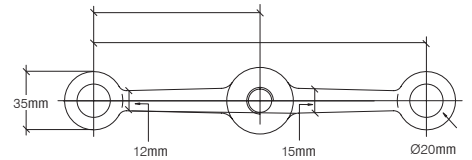
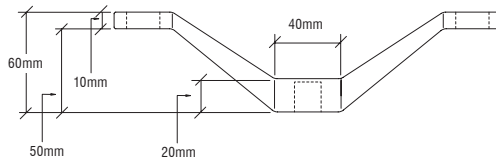
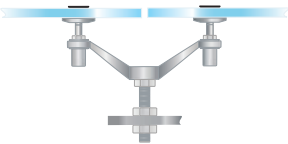

PMR2VBS
Brushed Stainless

PMR2VPS
Polished Stainless

CRL Double Arm "V" Regular Duty Post Mount Fitting

- For use with glass up to 12mm
- Complete with hardware to mount to post or column
- 316 stainless steel

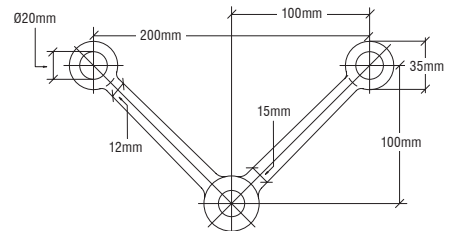
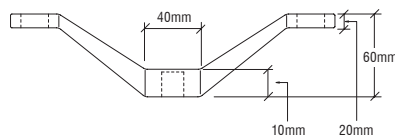
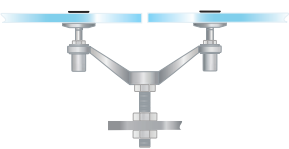

CRL Regular Spider Fixings

Grade 316 Stainless steel

CODE

DESCRIPTION



PMR2V90BS
Brushed Stainless

PMR2V90PS
Polished Stainless

CRL Double Arm "V" 90 Degree Regular Duty Post Mount Fitting

- For use with glass up to 12mm
- Complete with hardware to mount to post or column
- 316 stainless steel



**REGULAR
POST
MOUNT**

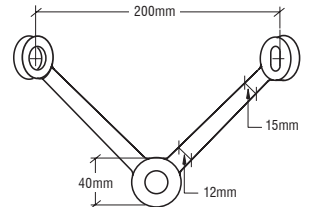
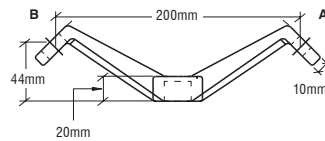
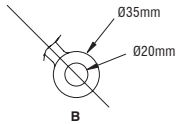
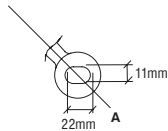
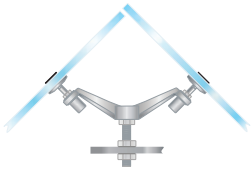

PMR3BS
Brushed Stainless

PMR3PS
Polished Stainless

CRL Three Arm Regular Duty Post Mount Fitting

- For use with glass up to 12mm
- Complete with hardware to mount to post or column
- 316 stainless steel



**REGULAR
POST
MOUNT**

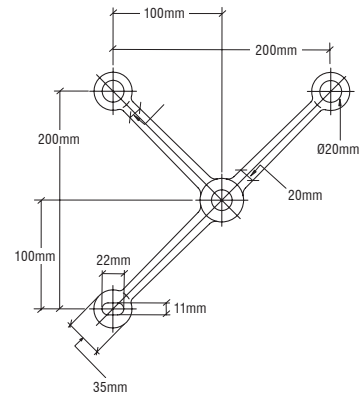
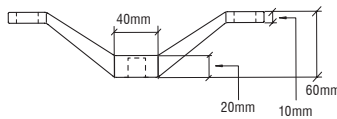
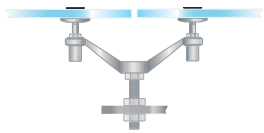

PMR4BS
Brushed Stainless

PMR4PS
Polished Stainless

CRL Four Arm Regular Duty Post Mount Fitting

- For use with glass up to 12mm
- Complete with hardware to mount to post or column
- 316 stainless steel



**REGULAR
POST
MOUNT**

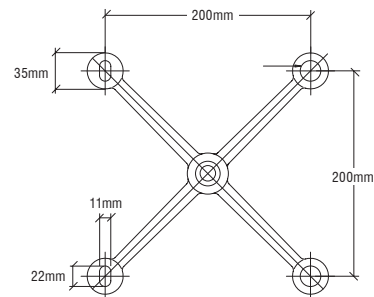
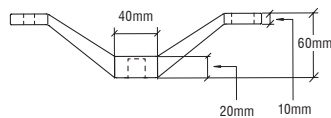
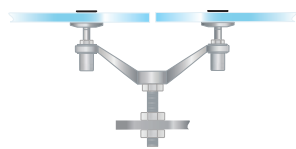

CODE

DESCRIPTION



PMR490BS
Brushed Stainless

PMR490PS
Polished Stainless

CRL Four Arm 90 Degree Regular Duty Post Mount Fitting

- For use with glass up to 12mm
- Complete with hardware to mount to post or column
- 316 stainless steel



**REGULAR
POST
MOUNT**

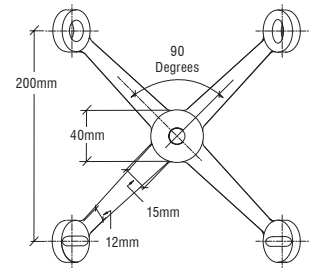
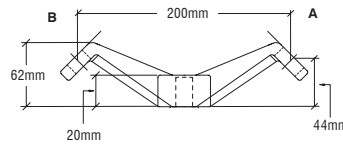
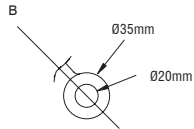
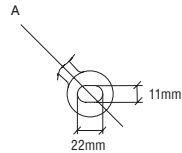
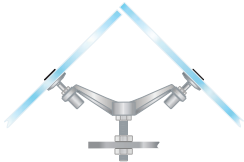

RRF10BS
Brushed Stainless

RRF10PS
Polished Stainless

CRL Rigid Head Combination Glass Attachment

- For use with 10mm to 12mm tempered glass
- 316 stainless steel



REGULAR

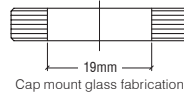
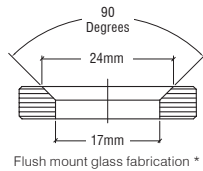

RSF10BS
Brushed Stainless

RSF10PS
Polished Stainless

CRL Swivel Head Combination Glass Attachment

- For use with 10mm to 12mm tempered glass
- 316 stainless steel



REGULAR

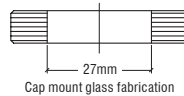
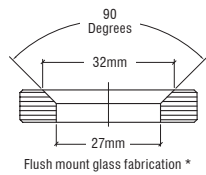

CRL Heavy Duty Spider Fixings

Heavy Duty Fittings - up to 27mm Glass

Grade 316 Stainless steel



FMH1LHBS
Brushed Stainless

FMH1LHPS
Polished Stainless

CRL Left Hand Single Arm Heavy-Duty Wall/Fin Mount Fitting

- For use with glass up to 27mm
- Complete with hardware to mount to wall or structural fin
- 316 stainless steel



HEAVY DUTY FIN MOUNT

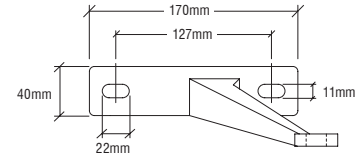
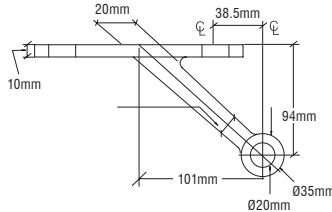
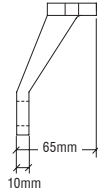
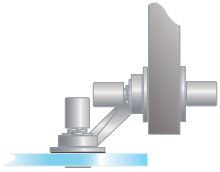

FMH1RHBS
Brushed Stainless

FMH1RHPS
Polished Stainless

CRL Right Hand Single Arm Heavy-Duty Wall/Fin Mount Fitting

- For use with glass up to 27mm
- Complete with hardware to mount to wall or structural fin
- 316 stainless steel



HEAVY DUTY FIN MOUNT

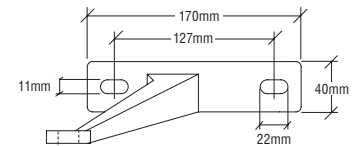
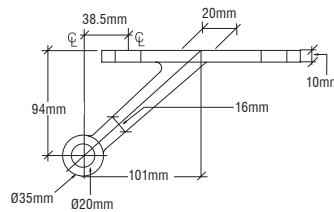
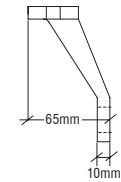
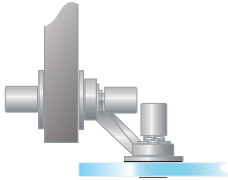

FMH1BS
Brushed Stainless

FMH1PS
Polished Stainless

CRL Single Arm Heavy-Duty Wall/Fin Mount Fitting

- For use with glass up to 27mm thick to attach a single glass panel to a wall or structural fin
- Complete with two threaded studs and two matching cap nuts with washers
- Brushed or polished stainless steel finishes
- 316 stainless steel



HEAVY DUTY FIN MOUNT

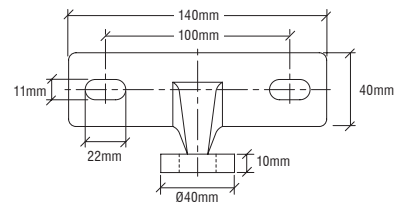
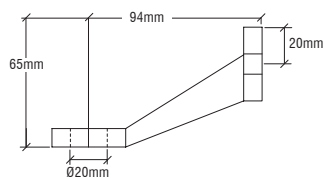
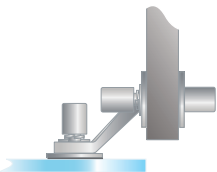

Glass attachments must be ordered separately (see page 95)



CODE

DESCRIPTION



FMH2BS
Brushed Stainless
FMH2PS
Polished Stainless

CRL Double Arm Heavy-Duty Wall/Fin Mount Fitting

- For use with glass up to 27mm thick to attach two inline glass panels to a structural fin
- Complete with two threaded studs and two matching cap nuts with washers
- Brushed or polished stainless steel finishes
- 316 stainless steel

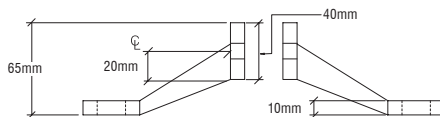
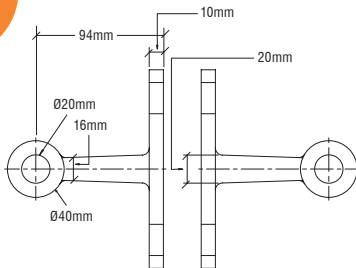
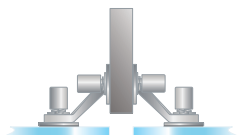

FMH2VBS
Brushed Stainless
FMH2VPS
Polished Stainless

CRL Double Arm "V" Heavy-Duty Wall/Fin Mount Fitting

- For use with glass up to 27mm
- Complete with hardware to mount to wall or structural fin
- 316 stainless steel

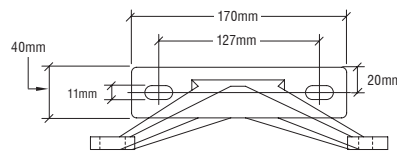
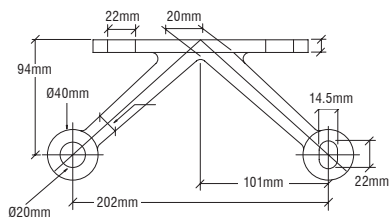
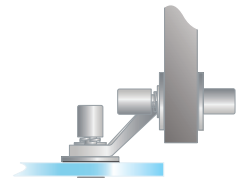

FMH4BS
Brushed Stainless
FMH4PS
Polished Stainless

CRL Four Arm "V" Heavy-Duty Wall/Fin Mount Fitting

- For use with glass up to 27mm thick to attach two inline glass panels to a structural center fin
- Complete with two threaded studs and four matching cap nuts with washers
- Brushed or polished stainless steel finishes
- 316 stainless steel

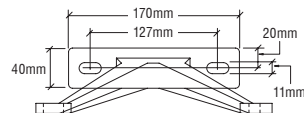
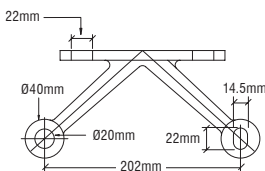
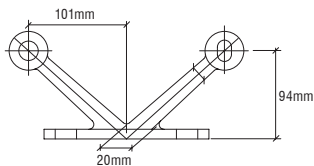
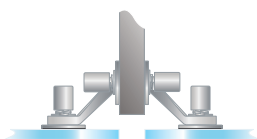

CRL Heavy Duty Spider Fixings

Grade 316 Stainless steel

CODE

DESCRIPTION



PMH1BS
Brushed Stainless
PMH1PS
Polished Stainless

CRL Single Arm Heavy-Duty Post Mount Fitting

- For use with glass up to 27mm thick to attach a single glass panel to a structural end post
- Complete with hardware to mount to post or column
- Brushed or polished stainless steel finishes
- 316 stainless steel



HEAVY DUTY POST MOUNT

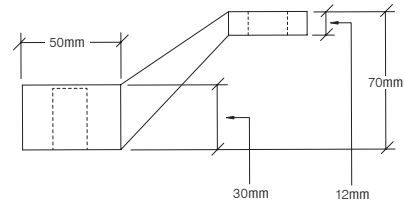
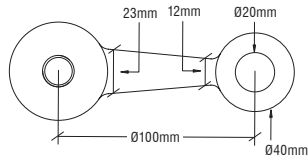
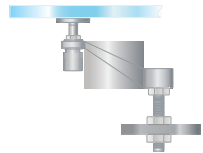

PMH1LBS
Brushed Stainless
PMH1LPS
Polished Stainless

CRL Single Long Arm Heavy-Duty Post Mount Fitting

- For use with glass up to 27mm
- Complete with hardware to mount to post or column
- 316 stainless steel



HEAVY DUTY POST MOUNT

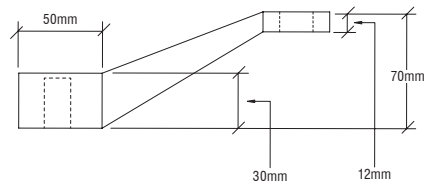
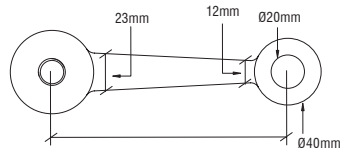
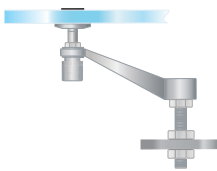

PMH2BS
Brushed Stainless
PMH2PS
Polished Stainless

CRL Double Arm Heavy-Duty Post Mount Fitting

- For use with glass up to 27mm thick to attach two inline glass panels to a structural center post
- Complete with hardware to mount to post or column
- Brushed or polished stainless steel finishes
- 316 stainless steel



HEAVY DUTY POST MOUNT

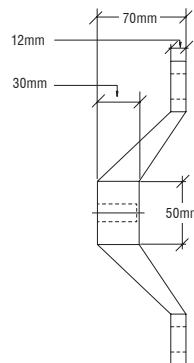
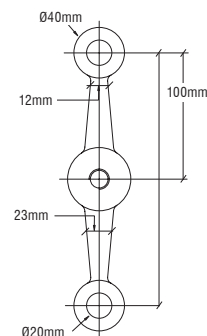
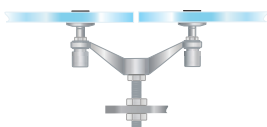

Glass attachments must be ordered separately (see page 95)



CODE

DESCRIPTION



PMH2V90BS
Brushed Stainless

PMH2V90PS
Polished Stainless

CRL Double Arm "V" 90 Degree Heavy-Duty Post Mount Fitting

- For use with glass up to 27mm
- Complete with hardware to mount to post or column
- 316 stainless steel

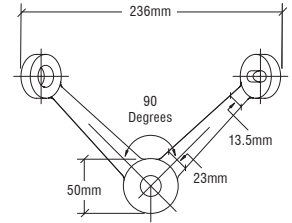
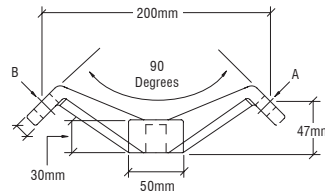
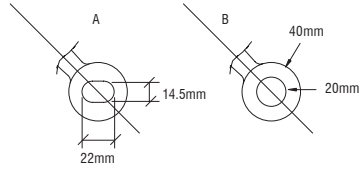
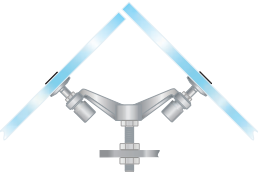

PMH3BS
Brushed Stainless

PMH3PS
Polished Stainless

CRL Three Arm Heavy-Duty Post Mount Fitting

- For use with glass up to 27mm
- Complete with hardware to mount to post or column
- 316 stainless steel

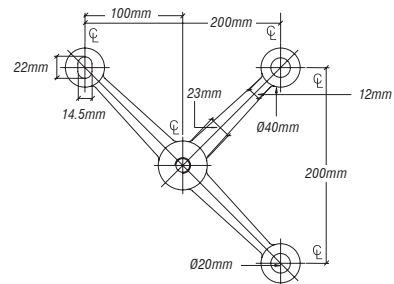
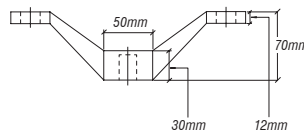
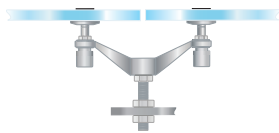

CRL Heavy Duty Spider Fixings

Grade 316 Stainless steel

CODE **DESCRIPTION**



PMH4BS
Brushed Stainless

PMH4PS
Polished Stainless

CRL Four Arm Heavy-Duty Post Mount Fitting

- For use with glass up to 27mm thick to attach two inline glass panels to a structural center post
- Complete with hardware to mount to post or column
- Brushed or polished stainless steel finishes
- 316 stainless steel

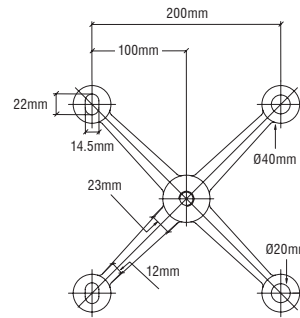
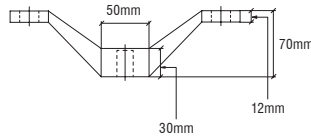
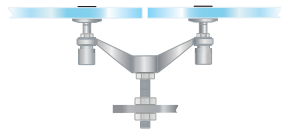

PMH490BS
Brushed Stainless

PMH490PS
Polished Stainless

CRL 4-Way Arm 90 Degree Heavy-Duty Post Mount Fitting

- For use with glass up to 27mm
- Complete with hardware to mount to post or column
- 316 stainless steel

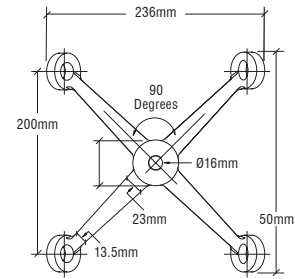
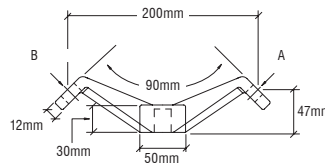
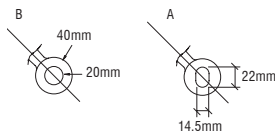
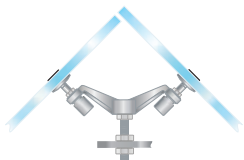

CODE

DESCRIPTION



HRF14BS
Brushed Stainless

HRF14PS
Polished Stainless

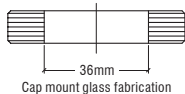
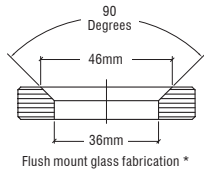

CRL Rigid Head Combination Glass Attachment

- One fitting for either flush or surface mount installations
- For use with 12mm to 27mm toughened or laminated glass
- Typically used only for interior applications
- Can be used with all Heavy-Duty Spider Fittings
- 316 stainless steel



HSF14BS
Brushed Stainless

HSF14PS
Polished Stainless

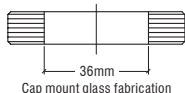
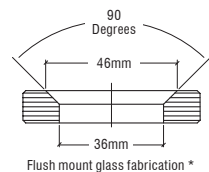

CRL Swivel Head Combination Glass Attachment

- One fitting for either flush or surface mount installations
- Head can swivel up to 6 degrees in any direction on its ball and socket joint
- For use with 12mm to 27mm toughened or laminated glass
- Can be used with all Heavy-Duty Spider Fittings
- 316 stainless steel



HS1GF14BS
Brushed Stainless

HS1GF14PS
Polished Stainless



CRL Brushed Stainless Swivel Heavy Duty Insulating Glass Fastener

- Designed for the "all glass" look
- For use with 32mm insulated glass unit
- Tilts up to 6 degrees in any direction on its wall and socket joint. This allows for any stress applied to the glass to be more evenly distributed across the entire panel of glass rather than concentrating at the hole
- 316 stainless steel



HSFE14BS
Brushed Stainless



CRL Brushed Stainless Heavy-Duty Exterior Swivel Fastener

- Designed for the "all glass" look
- For use with 12mm to 22mm tempered glass
- 316 stainless steel



CRL Spider Fixings

Grade 316 Stainless steel

CODE

DESCRIPTION



FTF12BS

For Fin Size 305mm
Brushed Stainless

FTF16BS

For Fin Size 406mm
Brushed Stainless

FTF12PS

For Fin Size 305mm
Polished Stainless

FTF24BS

For Fin Size 610mm
Brushed Stainless

CRL Fin Top/Bottom Shoe Fittings for 19mm Glass

- Fin Top/Bottom Shoe Fittings are used to connect the glass fins to the structure of the floor or ceiling
- 316 stainless steel

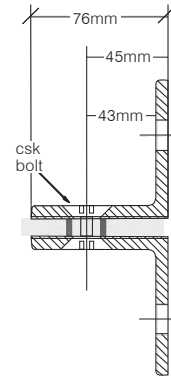

FSF12BS

For Fin Size 305mm
Brushed Stainless



FSF16BS

For Fin Size 406mm
Brushed Stainless

CRL Fin Splice Fittings for 19mm Glass

- Fin Splice Fittings are used to stack multiple pieces of glass to construct extra tall fins used to stabilize the glass facade.
- 316 stainless steel

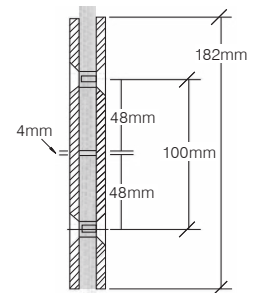

CODE

DESCRIPTION

AMS0B112CBS
Regular Duty 38mm
Brushed Stainless

AMS0B2CBS
Heavy-Duty 51mm
Brushed Stainless

AMS0B112CPS
Regular Duty 38mm
Polished Stainless

AMS0B2CPS
Heavy-Duty 51mm
Polished Stainless

CRL Spider Fitting Post Adapters (Custom Length)

- Available for Round or Flat Posts
- Custom Length to Your Specifications
- 316 stainless steel

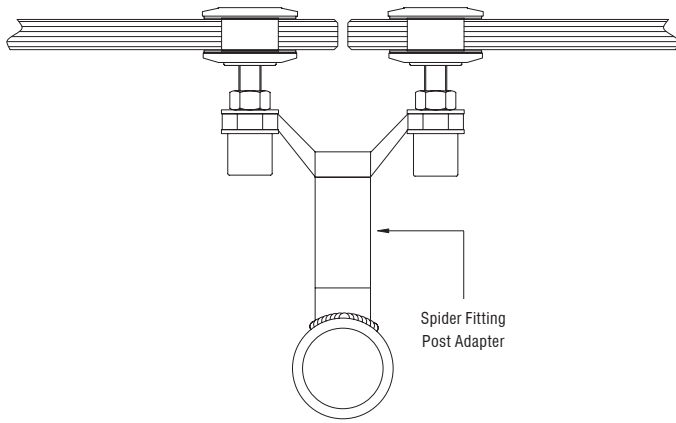

FSFHDBS
316 Stainless Steel

CRL Splice Fitting for Curtainwall Fin

- Use to stabilise glass facade
- For use on 19mm tempered glass
- Made of 316 alloy stainless steel
- Tested to meet ASTM E283, E331, E330, AAMA 501



CBP90BS
Brushed Stainless

CRL 90 Degree Corner Bracket

- Used to secure glass at 90 degree corners
- Supplied with four rigid countersunk glass connecting screws
- 316 stainless steel

CBP90PS
Polished Stainless

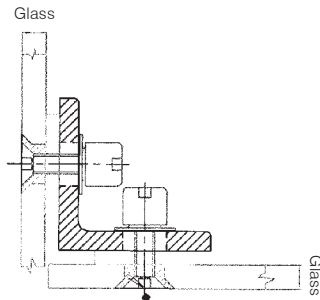
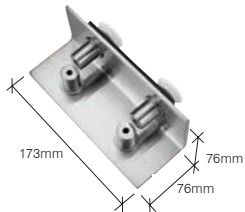
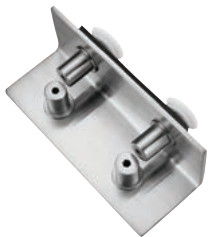

CRL Spider Fixings

Grade 316 Stainless steel

CODE

DESCRIPTION

CBP135BS
Brushed Stainless

CBP135PS
Polished Stainless

CRL 135 Degree Corner Bracket

- Used to secure glass at 135 degree corners
- Supplied with four rigid countersunk glass connecting screws
- 316 stainless steel

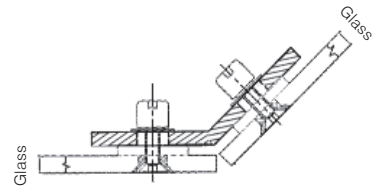
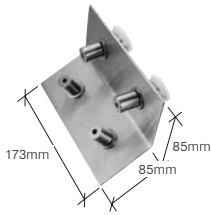

CCB2BS
Brushed Stainless

CCB2PS
Polished Stainless

CRL 2-Way Glass/ 1-Way Wall Circular Bracket

- Used to link two inline panels of glass to a fin support behind
- Used to connect one or two inline panels to a fin support or, when split apart they can be used to connect one panel to a wall
- Supplied with two rigid countersunk glass connecting screws and one fin securing bolt
- 316 stainless steel

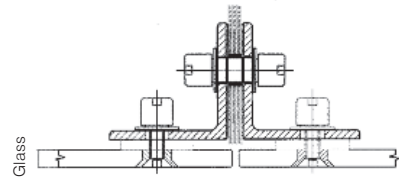

CCB4BS
Brushed Stainless

CRL 4-Way Glass/ 2-Way Wall Circular Bracket

- Used to link two or four inline panels of glass to a fin support behind
- Used to connect two or four inline panels to a fin support or, when split apart they can be used to connect one or two panels to a wall
- Supplied with four rigid countersunk glass connecting screws and two fin securing bolt
- 316 stainless steel

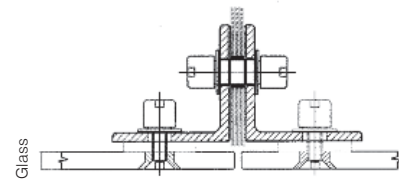
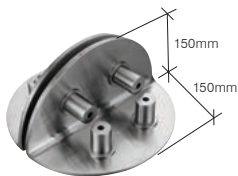

CODE

DESCRIPTION



CLB1BS
Brushed Stainless

CLB1PS
Polished Stainless

CRL Link Bracket

- Used to connect two 12mm inline glass panels together to reduce differential deflection
- Supplied with two glass connecting screws

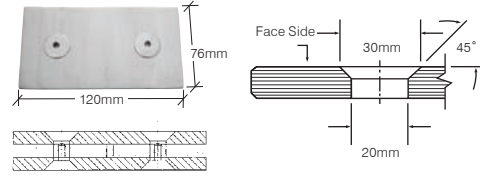

M8SBSS
Brushed Stainless

**CRL Stainless Steel Sex Bolt**

- Countersunk head
- For use with Cat. No. FTF12, FTF16, FTF20, FTF24, FSF12, FSF16, FSF20, FSF24 and CLB1 Fittings and Brackets.
- Sold per package which contains 10 sets

USW10

**CRL Universal Spanner Wrench Kit**

- Adjustable universal wrench
- Includes metric and fractional spanner pin sets
- Fits CRL brand Laguna Series brackets and spider fittings to glass
- Quick and efficient method of attaching or loosening spanners



GET YOUR G&G CATALOGUE

TOOLS & ACCESSORIES FOR GLASS



+ MANY MORE

CALL FREE ON 00 800 0421 6144 TO REQUEST YOUR FREE COPY

CRL Glass Awning Wall Mounted Brackets



- Used on flat or curved top segmented glass
- Fabricated from 304 alloy stainless steel
- Available in brushed or polished stainless
- Custom angles or 45 degree corner brackets are available on special order
- Requires 13.52mm thick toughened laminated glass

These universal wall mounted glass awning brackets have really become popular, not just for their looks but also their versatility.

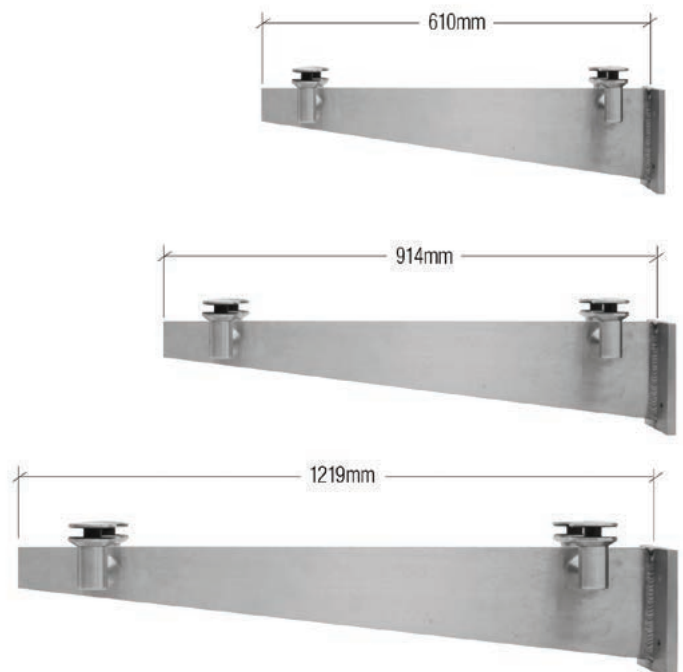

CODE	DESCRIPTION
GAB24BS	CRL universal wall mounted brushed stainless 610mm glass awning bracket
GAB36BS	CRL universal wall mounted brushed stainless 914mm glass awning bracket
GAB48BS	CRL universal wall mounted brushed stainless 1219mm glass awning bracket

Also available in polished stainless finish. See crlaurence.co.uk for details. Wall Mounted Bracket includes 2x Arm Fittings, Swivel or Fixed upon request

CRL Glass Awning Wall Mounted Brackets

CODE

DESCRIPTION

RB50FBS

CRL Double Arm Fixed Fitting Set

RB50FPS

- Fabricated from 316 alloy stainless steel
- Available in brushed or polished stainless

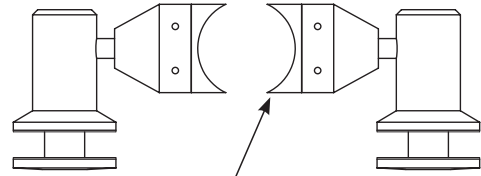

Fixed Fitting

Designed for mounting to 38mm schedule 40 post, column, or flat wall.

RB50SBS

CRL Double Arm Swivel Fitting Set

RB50SPS

- Fabricated from 316 alloy stainless steel
- Available in brushed or polished stainless

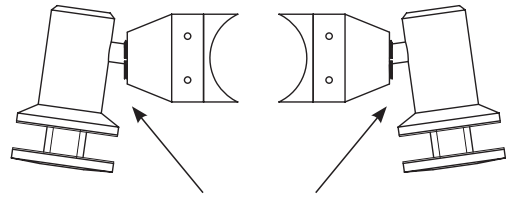

Swivel Fitting

Designed for segment applications. Each Swivel Fitting is adjustable up to 8 degrees.

CRL Installation



- High grade 316 stainless steel for durability in even the harshest of environments
- Complete hardware system for 13.52mm toughened laminated glass awnings
- Provides protection from the weather without obstructing the view
- Adjustable slope for most weather conditions
- All high grade 316 alloy stainless steel components for panel sizes up to 1219mm wide and 1829mm long with two rods and mounting kits
- Easy Installation

The CRL Glass Awning Support System will give any entrance an uncomplicated, graceful look, enhancing the design of any building.

With the use of toughened laminated glass you can add a range of glass colours, textures, and special effects not available with typical monolithic glass. This complements and enhances the design of any building.

The use of eye and fork connections makes the installation of our Awning System quick and easy. The Connecting Rods are designed to make field adjustments on varying job conditions a snap. All components are 316 alloy stainless steel for durability in even the harshest of environments.

Specifications

Material: All 316 alloy stainless steel construction.

Typical Panel: 13.52mm thick toughened laminated glass comprised of 6mm toughened glass, 1.52mm interlayer, and 6mm toughened glass.

Glass Fabrication Required: Two 16mm and two 27mm diameter holes per panel.

Ordering Tip: Though sold individually, two Connecting Rods and two Mounting Kits are required for each panel.

See crlaurence.co.uk for glass fabrication details

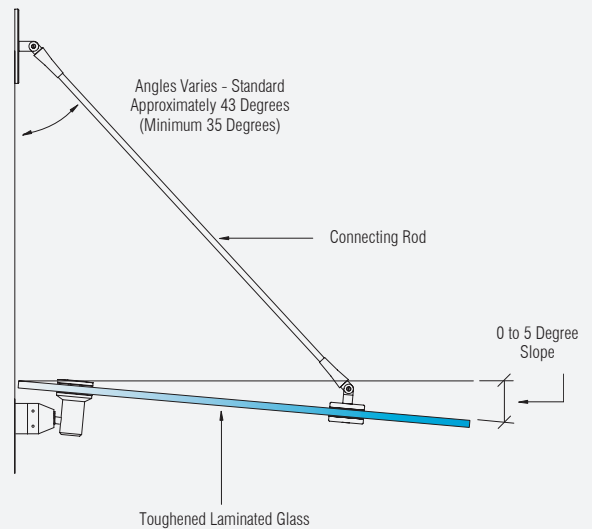

System Components

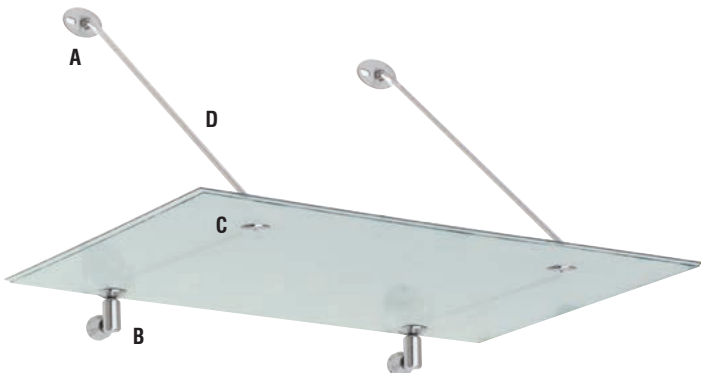

Stainless Steel Mounts (A and B) and Pivots (C) are contained in the GAS190BS Mounting Kit. Order Connecting Rods (D) to suit panel width and application conditions. These are contained in GAS137BS, GAS145BS and GAS154BS.

NOTE: Glass panel not included.

CRL Langle Mounting Kit

Oval top mounting bracket and pivot for edge of glass furthest from building are connected by one of three available rod lengths.

Bottom Mount and Pivot are connected to each other to support edge of glass nearest the building.

Grade 316 Stainless steel



CODE	DESCRIPTION
GAS190BS	<p>CRL Langle mounting kit</p> <ul style="list-style-type: none"> • High grade 316 stainless steel for durability in even the harshest of environments • Complete hardware system for 13.52mm toughened laminated glass awnings • Provides protection from the weather without obstructing the view • Adjustable slope for most weather conditions • All high grade 316 alloy stainless steel components for panel sizes up to 1219mm wide and 1829mm long with two rods and mounting kits • Easy installation allows an economical and elegant solution for both commercial and residential applications

Connecting Rods

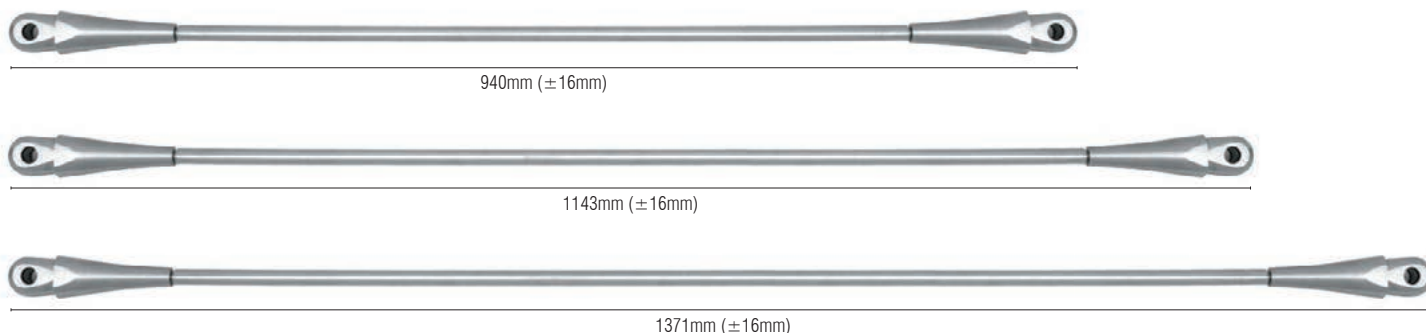

CODE	DESCRIPTION
GAS137BS	CRL Langle 940mm glass awning system connecting rod for 914mm wide panels
GAS145BS	CRL Langle 1143mm glass awning system connecting rod for 1067mm wide panels
GAS154BS	CRL Langle 1372mm glass awning system connecting rod for 1219mm wide panels

CRL Double Plate Glass Awning Pivot

- Fabricated from 316 alloy stainless steel
- Available in brushed or polished stainless

This CRL Double Plate Glass Awning Pivot is for use with our Glass Awning System Support Rods. The Pivot allows for two awning panels to be attached in-line using only one Tension Rod at the connection point instead of two.



CODE	DESCRIPTION
GAS122BS	<p>CRL Langle double plate glass awning pivot</p> <ul style="list-style-type: none"> • Complete hardware system for 13.52mm toughened laminated glass awnings • Provides protection from the weather without obstructing the view • Adjustable slope for most weather conditions • All high grade 316 alloy stainless steel components for panel sizes up to 1219mm wide and 1829mm long with two rods and mounting kits • Easy installation allows an economical and elegant solution for both commercial and residential applications



CRL Glass Awning Systems

CRL Glass Awning Support System

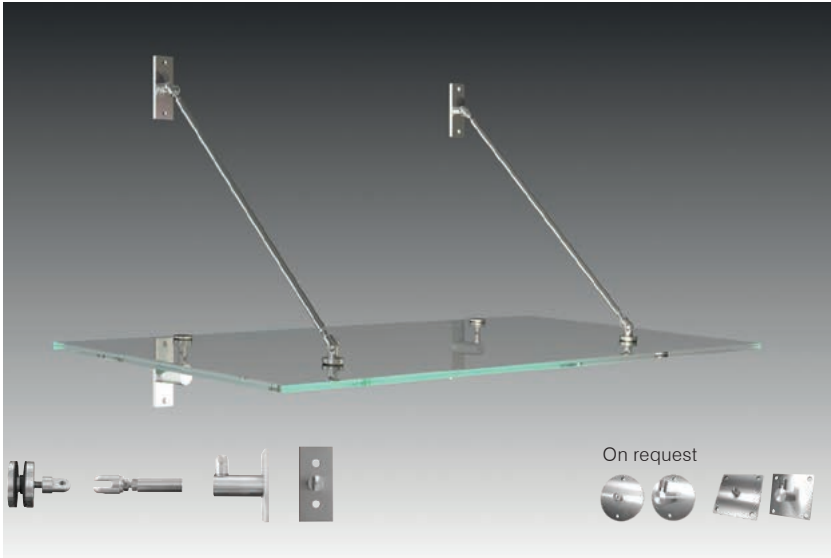

- AbZ Certified
- Sold as set
- AISI 304 Grade Stainless Steel
- Brushed Stainless Steel finish
- Corrosion protection class 2, DIN EN 10088
- Glass thickness range 17.52mm to 21.52mm
- Material Grade 316 Stainless Steel available on request

Set consisting of:

- 4 point fittings Ø 45mm with mounting link
- 2 upper fastening plates
- 2 lower fastening plates
- 2 tie rods with yoke
- without glass

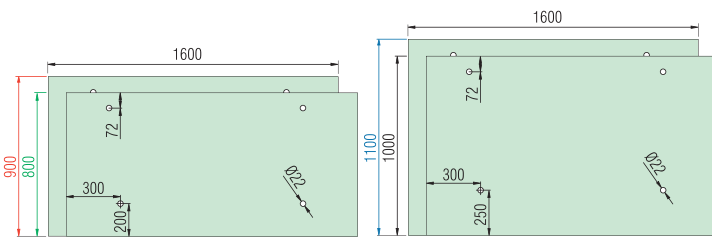

Glass: laminated safety glass consisting of heat strengthened glass with quadruple foil 8/1.52/8mm or 10/1.52/10mm

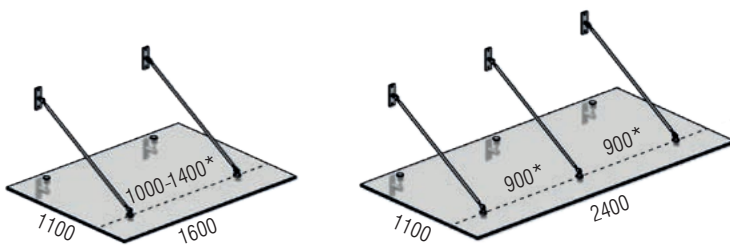
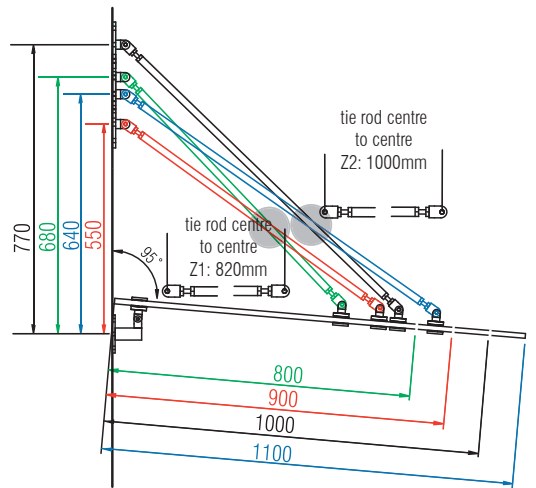

* max. tie rod distance

Tie rods	Fittings	Glass thickness	Max. design load
2	4	2 x 8mm	2.16 kN/m ²
2	4	2 x 10mm	3.43 kN/m ²
3	6	2 x 8mm	1.84 kN/m ²
3	6	2 x 10mm	2.95 kN/m ²

Please order for 3ea rod additional CAT.NO. EUGAS9001BS / EUGAS11001BS.

CAT. NO.	FASTENING PLATES	DESCRIPTION	OVERHANG	TIE ROD	CANOPY SLOPE
EUGAS900BS	Rectangular	CRL Awning Kit for 900mm	800 - 900mm	Z1 (820mm)	max. 10°
EUGAS1100BS	Rectangular	CRL Awning Kit for 1100mm	1000 - 1100mm	Z2 (1000mm)	max. 10°

CRL Awning Kit for 1300mm Projection Glass Canopy

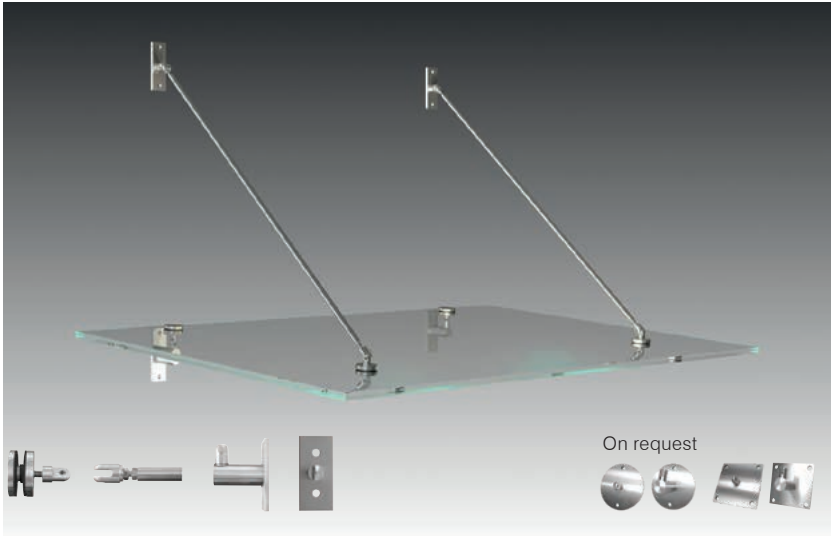

- AbZ Certified
- Sold as set
- AISI 304 Grade Stainless Steel
- Brushed Stainless Steel finish
- Corrosion protection class 2, DIN EN 10088
- Glass thickness range 21.52mm to 25.52mm
- Material Grade 316 Stainless Steel available on request

Set consisting of:

- 4 point fittings Ø 60mm with mounting link
- 2 upper fastening plates
- 2 lower fastening plates
- 2 tie rods with yoke
- Without glass

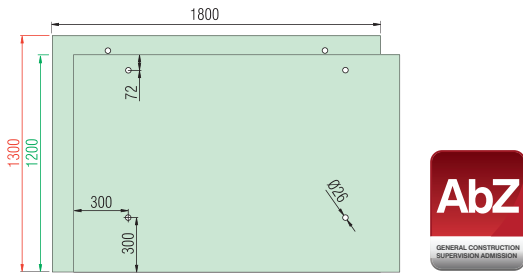

Glass: laminated safety glass consisting of heat strengthened glass with quadruple foil 10/1.52/10mm or 12/1.52/12mm

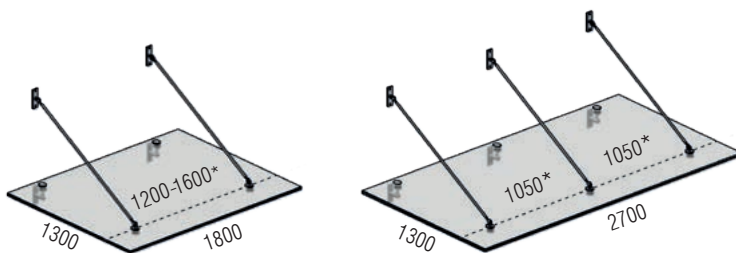
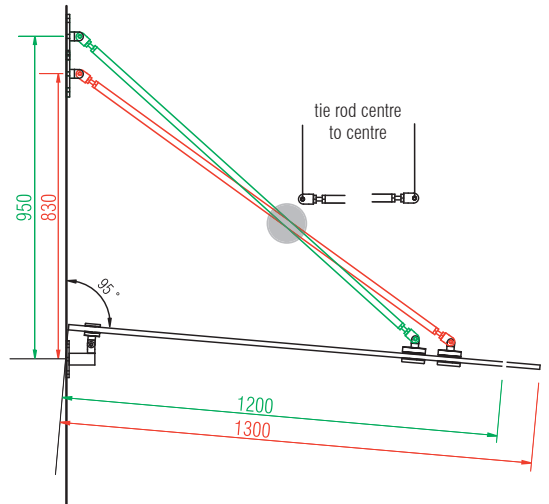

* max. tie rod distance

Tie rods	Fittings	Glass thickness	Max. design load
2	4	2 x 10mm	3.01 kN/m ²
2	4	2 x 12mm	4.43 kN/m ²
3	6	2 x 10mm	2.55 kN/m ²
3	6	2 x 12mm	3.89 kN/m ²

Please order for 3ea rod additional CAT.NO. EUGAS13001BS.

CAT. NO.	FASTENING PLATES	DESCRIPTION	OVERHANG	TIE ROD	CANOPY SLOPE
EUGAS1300BS	Rectangular	CRL Awning Kit for 1300mm	1200 - 1300mm	Z3 (1250mm)	max. 10°

CRL Awning Kit for 1600/2000mm Projection Glass Canopy

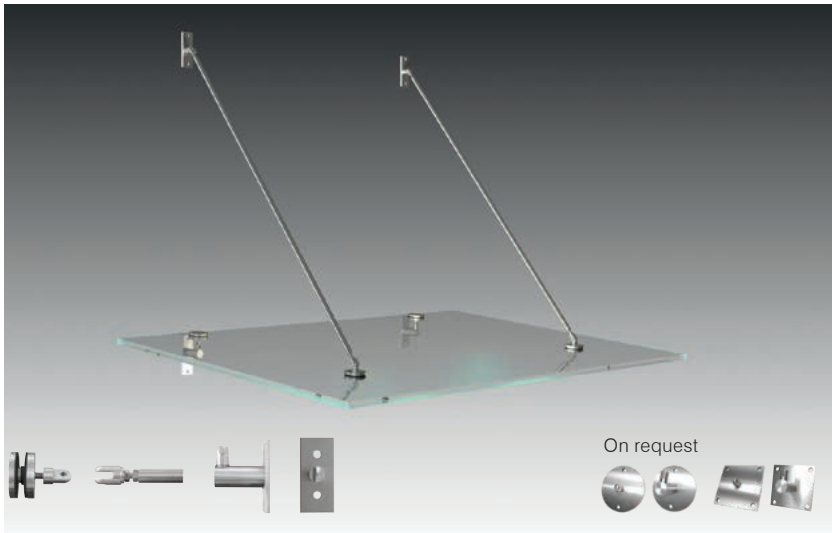

- AbZ Certified
- Sold as set
- AISI 304 Grade Stainless Steel
- Brushed Stainless Steel finish
- Corrosion protection class 2, DIN EN 10088
- Glass thickness range 21.52mm to 25.52mm
- Material Grade 316 Stainless Steel available on request

Set consisting of:

- 4 point fittings Ø 80mm with mounting link
- 2 upper fastening plates
- 2 lower fastening plates
- 2 tie rods with yoke
- Without glass

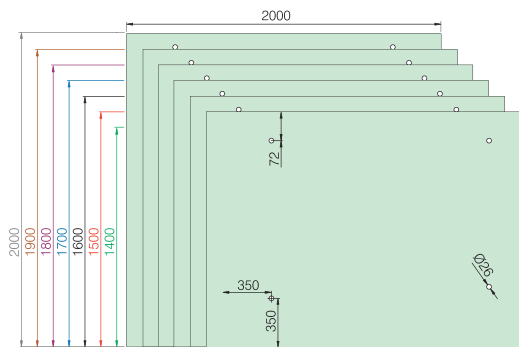

Glass: laminated safety glass consisting of heat strengthened glass with quadruple foil 10/1.52/10mm or 12/1.52/12mm

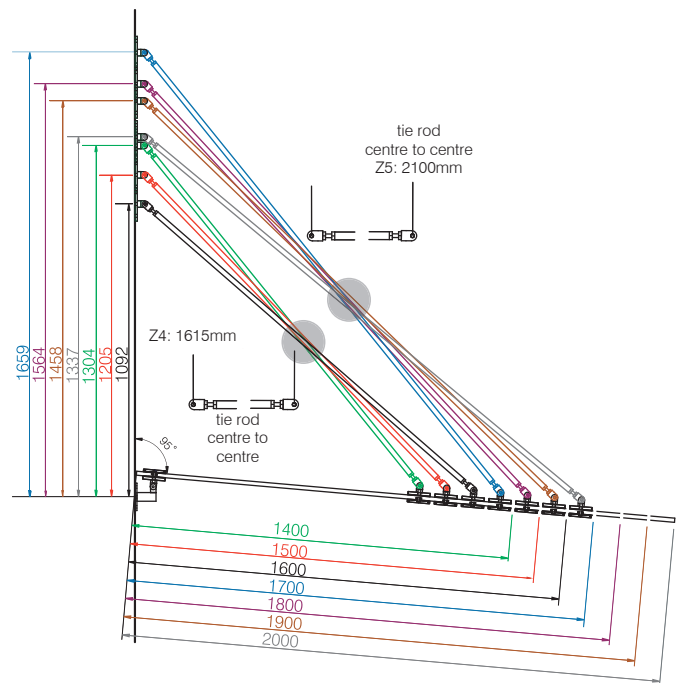

Tie rods	Fittings	Glass thickness	max. design load
2	4	2 x 10mm	2,07 kN/m ²
2	4	2 x 12mm	3,09 kN/m ²
3	6	2 x 10mm	1,27 kN/m ²
3	6	2 x 12mm	1,83 kN/m ²

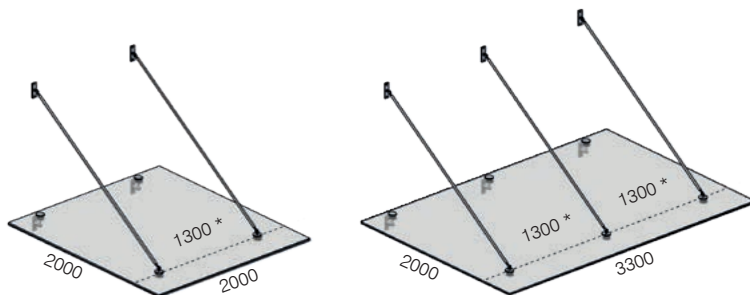

* max. tie rod distance

Please order for 3ea rod additional CAT.NO. EUGAS16001BS / EUGAS20001BS.

CAT. NO.	FASTENING PLATES	DESCRIPTION	OVERHANG	TIE ROD	CANOPY SLOPE
EUGAS1600BS	Rectangular	CRL Awning Kit for 1600mm	1400 - 1600mm	Z4 (1615mm)	max. 10°
EUGAS2000BS	Rectangular	CRL Awning Kit for 2000mm	1700 - 2000mm	Z5 (2100mm)	max. 10°

CRL Awning Brackets for 785mm Projection Glass Canopy

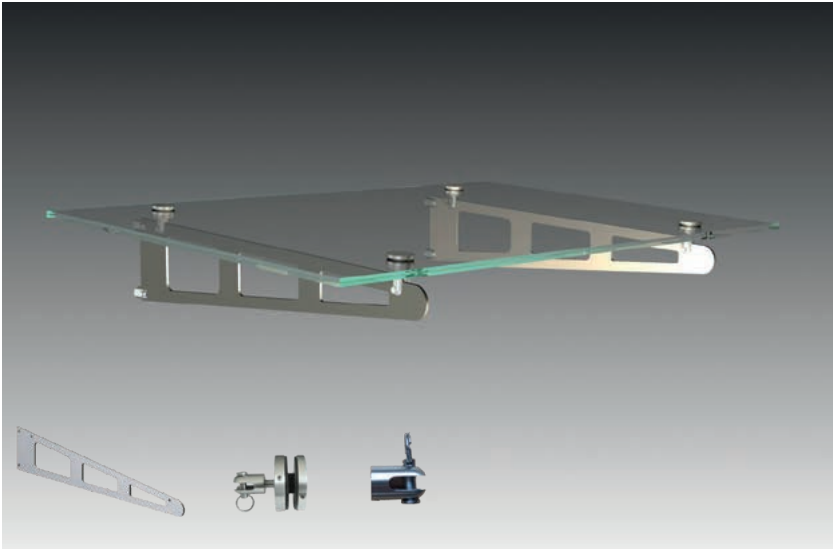

- Sold as set
- Proven static available
- AISI 304 Grade Stainless Steel
- Corrosion protection class 2, DIN EN 10088
- Glass thickness range 13.52mm to 17.52mm
- Material grade 316 stainless steel available on request

Set consisting of:

- 2 blades
- 4 point fittings Ø 60mm with yoke
- Without glass

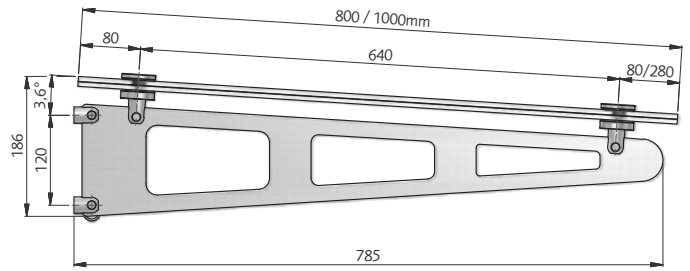
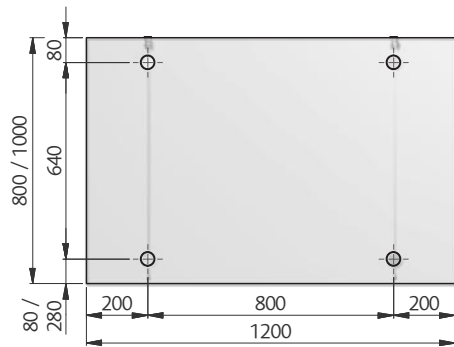

Glass: laminated safety glass consisting of heat strengthened glass with quadruple foil 6/1.52/6 mm or 8/1.52/8 mm

Blades	Overhang	Glass thickness	CRL Awning Brackets for 774mm
2	800	2 x 6mm	1.98 kN/m ²
2	800	2 x 8mm	4.14 kN/m ²
2	1000	2 x 6mm	1.34 kN/m ²
2	1000	2 x 8mm	2.70 kN/m ²
3	800 x 2300	2 x 6mm	1.50 kN/m ² (850)
3	800 x 2500	2 x 8mm	2.00 kN/m ² (950)
3	1000 x 2050	2 x 6mm	1.50 kN/m ² (725)
3	1000 x 2450	2 x 8mm	1.50 kN/m ² (925)

** max. charact. load

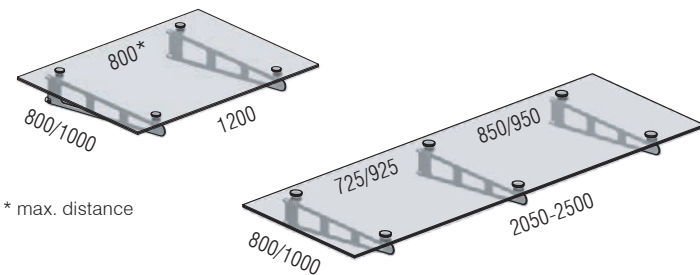

* max. distance

Please order for 3ea blade additional CAT.NO. EUGAB10001BS.

CAT. NO.	DESCRIPTION	OVERHANG	BLADE	OVERHANG	CANOPY SLOPE
EUGAB1000BS	CRL Awning Brackets for 785mm Projection Glass Canopy	Ø 60mm	785mm	800-1000mm	max. 3.6°

For a single bracket use CAT.NO. EUGAB10001BS

CRL Awning single components



YOU MAY ALSO NEED...

	CAT. NO.	OPTION	DESCRIPTION
	EUGAS45PF	Ø 45mm	Point fitting with link
	EUGAS60PF	Ø 60mm	
	EUGAS80PF	Ø 80mm	
	EUGAS820R0D	Z1 820mm (Small)	Tie rod with yoke
	EUGAS1000R0D	Z2 1000mm (Small)	
	EUGAS1250R0D	Z3 1250mm (Medium)	
	EUGAS1615R0D	Z4 1615mm (Large)	
	EUGAS2100R0D	Z5 2100mm (Large)	
	EUGASU	Rectangular	Upper fastening plate
	EUGASL	Rectangular	Lower fastening plate
	EUGASRDU	Round	Upper fastening plate
	EUGASRDL	Round	Lower fastening plate
	EUGASSQU	Square	Upper fastening plate
	EUGASSQL	Square	Lower fastening plate
	EUGASWRENCH45	Ø 45 - 60mm	Hook wrench for point fittings
	EUGASWRENCH80	Ø 80mm	
	EUGAS45DPF	Ø 45mm	Point fitting with spider 200 - glass connector for lower fastening plate and tie rod
		Ø 60mm	

	CAT. NO.	DESCRIPTION
 <div data-bbox="359 436 494 571" style="background-color: red; color: white; border-radius: 50%; padding: 10px; display: inline-block; text-align: center;"> STAGE ONE PRE-CLEAN </div>	<p>PC6010 100ml PC6025 250ml PC6050 500ml PC6100 1 Litre</p>	<p>CRL 6K Hydrophobic Surface Protection System for Glass and Stainless Steel</p> <div data-bbox="1268 257 1520 324" style="background-color: #0056b3; color: white; padding: 5px; text-align: right;"> Own Label Version Available </div> <ul style="list-style-type: none"> Stage one - Pre-clean Thoroughly cleans glass or stainless steel ready for the protection stage Ideal for shower screens and glass railings Recommended for use with the crl Pre-cleaning Cloth (red) Dries streak-free Conforms to EN 45001
 <div data-bbox="359 851 494 985" style="background-color: #0056b3; color: white; border-radius: 50%; padding: 10px; display: inline-block; text-align: center;"> STAGE TWO PROTECT </div>	<p>6K6010 100ml 6K6025 250ml 6K6050 500ml 6K6100 1 Litre</p>	<p>CRL 6K Hydrophobic Surface Protection System for Glass and Stainless Steel</p> <div data-bbox="1268 694 1520 761" style="background-color: #0056b3; color: white; padding: 5px; text-align: right;"> Own Label Version Available </div> <ul style="list-style-type: none"> Stage two - Protect 3 year protection lifespan Protects glass or stainless steel Ideal for shower screens and glass railings Nano-technology Long lasting - wide coverage Conforms to EN 45001
	<p>PCCL0TH Red - Pre clean 6KCL0TH Blue - Protect</p>	<p>CRL Cloths for the 6K Hydrophobic Surface Protection System</p> <ul style="list-style-type: none"> Red cloth to be used with CRL6K Pre-clean products Blue cloth to be used with CRL6K Protect products
	<p>AC6050 500ml</p>	<p>CRL 6K Aftercare Glass Cleaner</p> <div data-bbox="1284 1568 1520 1635" style="background-color: #0056b3; color: white; padding: 5px; text-align: right;"> Recommended for use with 6K </div> <ul style="list-style-type: none"> Non-silicone based glass cleaner Leaves glass clear and smear-free Ideal for shower screens

CAT. NO.**DESCRIPTION**

EUCRL7528 660ml

**CRL Acetone Surface Cleaner**

- Cleans surfaces for UV adhesives
- Removes all traces of grease and oils and leaves no residue
- Evaporates quickly
- Contains no ozone depleting chemicals

CRLSSR010 100ml

CRLSSR025 250ml







**CRL Refresh - Stainless Steel Refresher/Cleaner**







- Semi-permanent anti-finger print effect and stain elimination
- Removes grease and finger prints
- Coats the surface to help conceal against further every day marking
- Can be used as a cleaner (for pre-cleaning) and coating (for overlaying stains)
- For structured or brushed stainless steel

CRLSSC600 600ml

**CRL Stainless Steel Cleaner**

- Cleans and polishes stainless steel
- Food Safe – Ideal for use in food preparation areas
- Excellent for restoring shine to railings, shop cabinets, lift doors and stainless steel equipment
- Helps retain surface gloss
- Ideal for plastic and chrome surfaces

	CAT. NO.	DESCRIPTION
 <p>EB1701 EB1701T</p>	<p>EB1701 660ml can EB1701A 100ml can EB1701T 1 Litre trigger spray</p>	<p>CRL Glass & Mirror Cleaner</p> <ul style="list-style-type: none"> • A long time favourite of the glass industry • Ammoniated formula with a pleasant aroma <p style="text-align: right; background-color: #4F81BD; color: white; padding: 5px;">Own Label Version Available</p>
	<p>1550</p>	<p>CRL Lint Free Glass Wipes</p> <ul style="list-style-type: none"> • New, convenient pop-up dispenser box • Strong, four-ply white paper wipes are virtually lint-free • Reinforced nylon scrim in both directions so they work great wet or dry • Six pop-up boxes in each case
	<p>EU33SC</p>	<p>CRL Acetic Cure Silicone Sealant</p> <ul style="list-style-type: none"> • Acetic cure formula • Plastic cartridges with screw-on nozzles • High modulus • 300ml cartridge • 12 per case • Special countertop display box
	<p>EUCCS</p>	<p>CRL Crystal Clear Silicone</p> <ul style="list-style-type: none"> • High clarity when cured • Applications include shower enclosures and speciality glass assemblies • 310ml cartridge • 12 per case • Special countertop display box
	<p>EURTV408C Clear EURTV408W White EURTV408BL Black EURTV408BR Brown EURTV408G Grey EURTV408A Anthracite EURTV408R Rosewood</p>	<p>CRL Neutral Cure Low Modulus Silicone</p> <ul style="list-style-type: none"> • Low odour, neutral cure formula • Compatible with insulating glass glazing • Excellent adhesion to most surfaces • High grade formula - low shrinkage • 300ml cartridge, 12 per case • Special countertop display box • Conforms to ISO 11600
	<p>EG310ULTRA White colour</p>	<p>CRL EG310Ultra Complete Adhesive</p> <ul style="list-style-type: none"> • MS polymer based • Neutral curing and odourless • Cures with atmospheric moisture • Super-fast bonding of mirrors, glass, wood, composite panels, and metal, to a range of substrates • Free of silicone and isocyanides • 290ml cartridge
	<p>ER3</p>	<p>CRL Standard Smooth Rod Caulking Gun</p> <ul style="list-style-type: none"> • Thumb pressure release button • Our best seller is also great value • Perfect for low viscosity materials

	CAT. NO.	DESCRIPTION
	55BSS	CRL Sealant Finishing Tool <ul style="list-style-type: none"> • Lightweight and flexible, simplifies tooling of sealants • Titanium catalyst material will not stick to silicone or other sealants • Measure approximately 83mm x 89mm • 5mm thick
	S338	CRL S338 Sure-Grip 203mm Vacuum Lifter <ul style="list-style-type: none"> • Greatest lifting capacity of any 203mm pump activated vacuum lifter • One hand pump and attachment for safety when needed • Superior "press-and-pump" attachment feature • Built-in vacuum loss indicator • Soft contoured sure-grip handle for comfort • Sturdy moulded carrying case
	N4000	CRL Wood's Powr-Grip® 203mm ABS Handle Vacuum Cup <ul style="list-style-type: none"> • 203mm diameter pad • Lightweight, heavy-duty ABS handle • Check valve allows re-pumping without loss of remaining vacuum • Release valve lever permits quick and complete release • Fast attachment on smooth, non-porous flat surfaces • Red-line indicator warns user of any vacuum loss • Supplied with protective carrying case
	N4950	CRL Wood's Powr-Grip® 203mm Metal Handle Vacuum Lifter <ul style="list-style-type: none"> • 203mm diameter pad • Durable metal handle • Check valve allows re-pumping without loss of remaining vacuum • Fast attachment on smooth, non-porous flat surfaces • Red-line indicator warns user of any vacuum loss • Release valve lever permits quick, complete release
	05062	CRL Aluminium Double Pad Vacuum Lifter <ul style="list-style-type: none"> • 60kg lifting capacity • 114mm diameter pads • Sturdily built traditional design aluminium frame • Each suction pad operates separately • Strong, lightweight aluminium
	VR04	CRL Standard 25mm Vinyl Roller Tool <ul style="list-style-type: none"> • Ideal for inserting all types of flat spline and roll-in gaskets • Made from solid aluminium with a hard coat anodised finish • Knurl diamond grip and a ball bearing wheel
	GT02	CRL Glasstrax Glass Dolly <ul style="list-style-type: none"> • Safe glass transport with large 272kg capacity • Self clamping action locks loads up to 50.8mm thick • One person can load and manoeuvre

GET YOUR G&G CATALOGUE

THE COMPLETE COLLECTION!

CALL FREE ON 00 800 0421 6144
TO REQUEST YOUR FREE COPY



CAT. NO. GG2014A



THE TOOLS AND ACCESSORIES FOR GLASS AND GLAZING CATALOGUE

Glass cutting, glass processing, glass handling tools, silicones, sealants and caulking tools, mirror products, mastics and adhesives, cleaning and surface protection, glazing accessories, safety - Personal Protection Equipment, architectural and glass hardware.

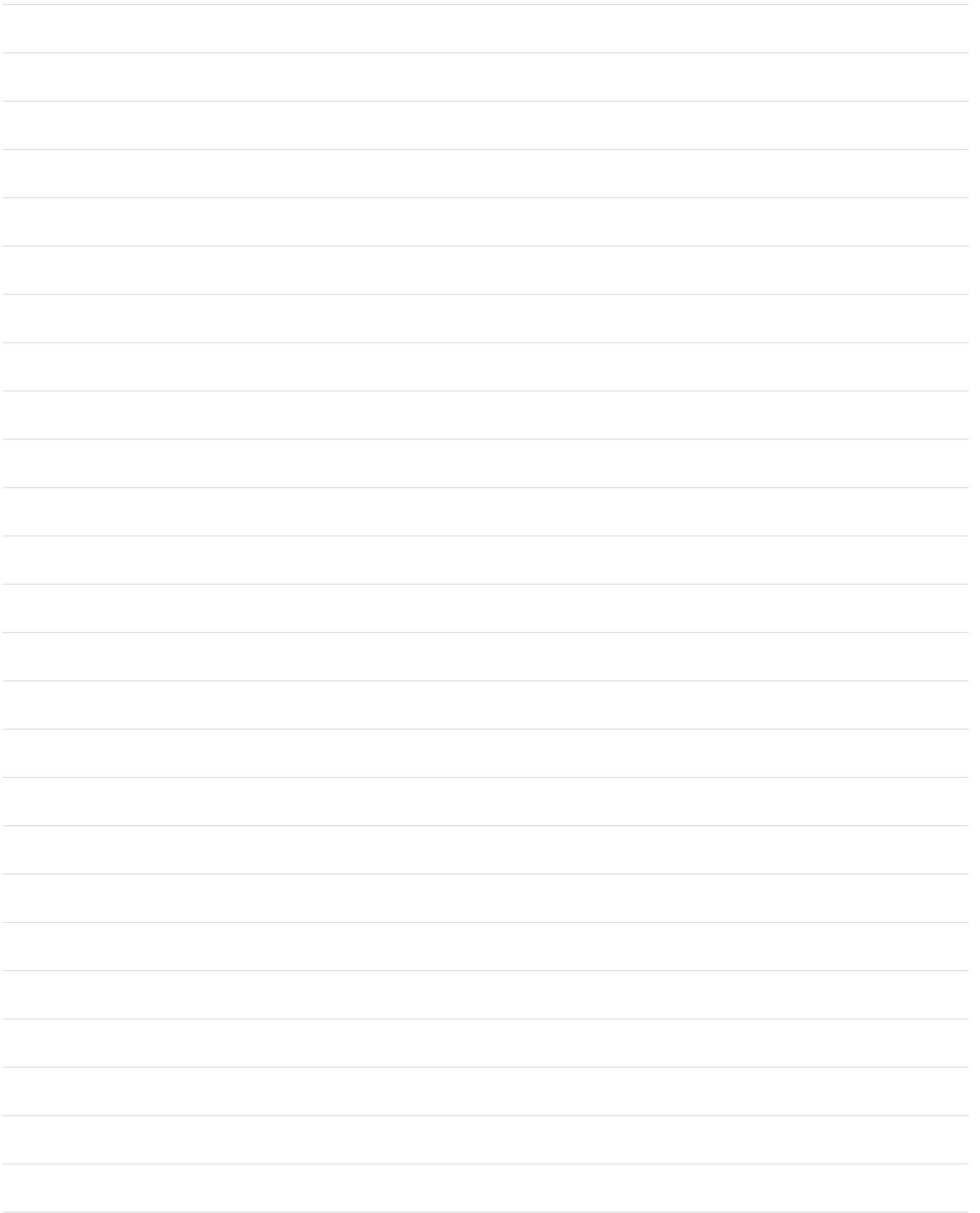

Call FREE on 00 800 0421 6144

Fax FREE on 00 800 0262 3299



Manchester

Charles Babbage Avenue
Kingsway Business Park,
Rochdale, OL16 4NW, England
Tel: +44 (0) 1706 863 600
Fax: +44 (0) 1706 869 860
crlaurence.co.uk



Stuttgart

Boschstrasse 7
D-74360 Ilsfeld
Germany
Tel: +49 (0) 7062 915 93 15
Fax: +49 (0) 7062 915 93 16
crlaurence.de



Copenhagen

Stamholmen 70 Unit B,
DK-2650 Hvidovre
Denmark
Tel: +45 36 72 09 00
Fax: +45 36 70 33 35
crlaurence.dk



France

Boschstrasse 7
D-74360 Ilsfeld
Germany
Tel: +49 (0) 7062 915 93 12
Fax: +49 (0) 7062 915 93 16
crlaurence.fr