

CRL®

Big discounts on our
most popular products

News & Spring Offers

PRICES VALID UNTIL 30TH JUNE 2024

Frame System for Interior Partitioning

see pages 4 & 5 for more details

Prices held for 2024

No general price increases with
permanent reductions on many items.

For all the latest offers,
sign up to our newsletter
at crlnews.co.uk

CRL Large D Shape Flat Back Glass Clamps

- For use on mezzanines, partitions, railings and windbreaks
- For 8 to 12.76 mm toughened or laminated glass
- Steel pin included for additional glass support
- Size 63 x 45 x 30 mm
- Sold individually
- 316 Grade Stainless Steel
- Matching flat rubber gaskets available, sold as a pair

Also available in radius back. Other gaskets available for other glass thicknesses



WAS £3.10
NOW FROM ONLY
£2.79*
EACH



Cat. No.	Description	Finish	For Use	1	50	100	500	1000
EUZFBBN	Large D Shape Flat Back Glass Clamp	Brushed Nickel	Internally	£4.26	£3.82	£3.47	£3.10	£2.79
EUZFBBS	Large D Shape Flat Back Glass Clamp	Brushed Stainless	Externally	£7.60	£6.75	£6.08	£5.40	-
EUZFBCH	Large D Shape Flat Back Glass Clamp	Chrome	Internally	£4.18	£3.80	£3.47	£3.10	£2.79
EUZFBPS	Large D Shape Flat Back Glass Clamp	Polished Stainless	Externally	£8.71	£7.75	£6.98	£6.19	-
NEW EUZFBSS	Large D Shape Flat Back Glass Clamp	Satin Brass	Internally	£4.49	£4.02	£3.66	£3.27	£2.94
EUZ10G	Rubber Gaskets - 8 mm Glass Thickness	-	-	£0.49	£0.40	£0.37	£0.35	£0.28
EUZ12G	Rubber Gaskets - 8 mm Glass Thickness	-	-	£0.49	£0.40	£0.37	£0.35	£0.28
EUZ8G	Rubber Gaskets - 8 mm Glass Thickness	-	-	£0.49	£0.40	£0.37	£0.35	£0.28

*Price based on an order quantity of 1000 (EUZFBBN).

CRL Square Type Flat Back Glass Clamps

- For use on mezzanines, partitions, railings and windbreaks
- For 6 to 10.76 mm glass
- Safety pin not included
- Size 45 x 45 x 27 mm
- Sold individually
- Matching flat rubber gaskets available, sold as a pair

Also available in radius back. Other gaskets available for other glass thicknesses



WAS £3.32
NOW FROM ONLY
£2.99*
EACH



Cat. No.	Description	Finish	Glass Thickness	For Use	1	50	100	500
EUZSFBBN	Square Type Flat Back Glass Clamp	Brushed Nickel	-	Internally	£3.48	£3.13	£2.99	-
EUZSFBCH	Square Type Flat Back Glass Clamp	Chrome	-	Internally	£3.97	£3.56	£3.33	£2.99
EUZS8G	Rubber Gaskets	-	8 mm	-	£0.22	£0.20	£0.18	-
EUZS10G	Rubber Gaskets	-	10 mm	-	£0.22	£0.20	£0.18	-

*Price based on an order quantity of 500 (EUZSFBCH).

CRL Refresh - Stainless Steel Refresher/Cleaner

- Semi-permanent anti-finger print effect and stain elimination
- Removes grease and finger prints
- Coats the surface to help conceal against further every day marking
- Can be used as a cleaner (for pre-cleaning) and coating (for overlaying stains)
- For structured or brushed stainless steel

WAS £9.52
NOW ONLY
£5.70*
EACH



Cat. No.	Bottle Size	1
CRLSSR025	250 ml	£5.70

*Price based on an order quantity of 1.

CRL Glass Rail Standoff Fittings Standard 51 mm Diameter Caps

- For use with 12 mm and 19 mm monolithic toughened glass or 13.5 mm and 21.5 mm laminated toughened glass using DuPont™ SentryGlas® Interlayers
- Two 19 mm diameter holes per fitting
- Full engineering data available at crlaurence.co.uk

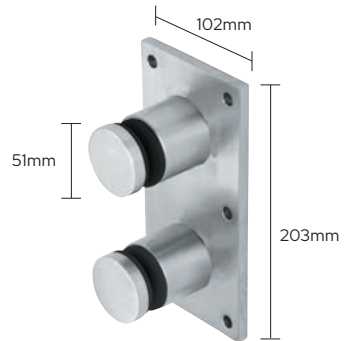

Cat. No.	Finish	1	20
RSOB20BS	Brushed Stainless Steel	£50.76	£46.53

*Price based on an order quantity of 20.

WAS £51.70
NOW FROM ONLY
£46.53*
EACH

CRL Glass Rail Standoff Base and Cap

- For use with 12 mm and 19 mm monolithic toughened glass or 13.5 mm and 21.5 mm laminated toughened glass using DuPont™ SentryGlas® Interlayers
- Designed for steel, wood and concrete substrates
- One 19 mm diameter hole per fitting
- 51 mm diameter caps
- 316 grade stainless finish



Cat. No.	Finish	1	20
RSOB2134BS	Brushed Stainless Steel	£30.89	£28.31

*Price based on an order quantity of 20.

WAS £31.46
NOW FROM ONLY
£28.31*
EACH

CRL Hydraulic Patch Door Set

- Includes a hydraulic patch fitting with backcheck, top door patch fitting and top centre-hung free swing pivot
- For 10 to 12 mm glass
- Visit crlaurence.co.uk for details of other finishes

~~WAS £111.94~~
NOW FROM ONLY
£95.15*
 EACH



Cat. No.	Description	Finish	1	6
CRL380MBLSET	No Hold Open	Matte Black	£107.04	£95.15
CRL380HMBLSET	Hold Open	Matte Black	£119.53	£106.24

*Price based on an order quantity of 6 (CRL380MBLSET).

CRL Patch Lock

- Euro profile cylinders to be ordered separately
- For 10 or 12 mm glass
- Visit crlaurence.co.uk for details of other finishes

~~WAS £17.18~~
NOW FROM ONLY
£14.60*
 EACH

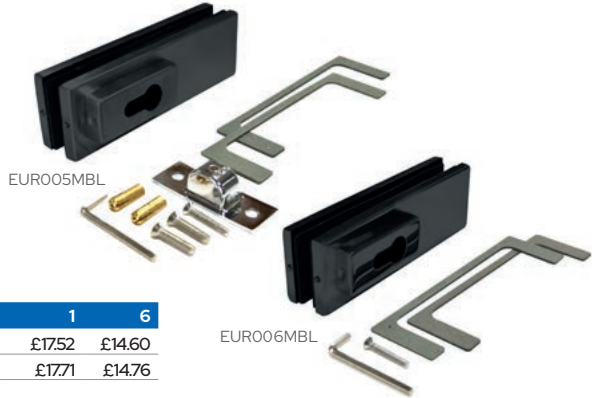

Cat. No.	Description	Finish	1	6
EURO05MBL	Corner Patch Lock	Matte Black	£17.52	£14.60
EURO06MBL	Centre Patch Lock	Matte Black	£17.71	£14.76

*Price based on an order quantity of 6 (EURO05MBL).

CRL Centre Patch Lock Keeper

- To be used with EURO06
- For 10 or 12 mm glass
- Visit crlaurence.co.uk for details of other finishes

~~WAS £10.93~~
NOW FROM ONLY
£9.29*
 EACH



Cat. No.	Finish	1	6
EURO06KMBL	Matte Black	£11.15	£9.29

*Price based on an order quantity of 6.

CRL Keyed Extended Length Cylinder

- For use with PTH311 Series lever latch installation and euro style patch locks EURO05 and EURO06
- Available in cylinder/thumbturn and cylinder/cylinder
- 60 mm length
- Visit crlaurence.co.uk for details of other finishes

~~WAS £8.20~~
NOW FROM ONLY
£6.97*
 EACH



Cat. No.	Finish	1	6
EC5MBL	Matte Black	£7.84	£6.97

*Price based on an order quantity of 6.

CRL Aluminium U-Channel for 10 mm Glass

- Wet glazed with clear silicone to secure glass
- Available in 2.49 m and 3.65 m stock lengths
- Available in up to 17 finishes - see crlaurence.co.uk

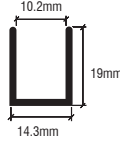

WAS £15.30
NOW FROM ONLY
£13.01*
EACH

Cat. No.	Finish	Length	Depth	1	10	40	80	120
SDCD38MBL	Matte Black	2.49 m	19 mm	£16.71	£15.72	£14.14	£13.42	£13.01

*Price based on an order quantity of 120.

CRL Corner Profile

- To be used with 10 mm thick toughened glass
- 90 degree aluminium corner profile to be used with SDCD38 U-channel
- Wet glazed with clear silicone to secure glass
- None structural framing
- Used to create a complete frame look when using SDCD38 U-channel
- Used with EUFB19 flat bar for a stylistic appearance
- 2410 mm long

WAS £20.35
NOW FROM ONLY
£17.30*
EACH



Cat. No.	Finish	1	10	20
SDCP38MBL	Matte Black	£22.49	£19.56	£17.30

*Price based on an order quantity of 20.

CRL Matte Black Aluminium Profile

- Flat aluminium profile
- Ideal for creating lattices on all-glass partition walls (loft-style)
- 19 mm wide, 1.5 mm thickness
- Visit crlaurence.co.uk for details of other finishes

WAS £5.16
NOW FROM ONLY
£4.39*
EACH



Cat. No.	Finish	1	10	20
EUFB19MBL	Matte Black	£6.16	£5.13	£4.39

*Price based on an order quantity of 20.

CRL T-Style Door Pull Handles

- Grade 316 Stainless Steel
- Sold per pair
- For 10 to 12 mm glass
- Visit crlaurence.co.uk for details of other finishes and lengths

WAS £44.05
NOW FROM ONLY
£37.44*
EACH



Cat. No.	Length	Diameter	Centre-to-Centre	Finish	1	5
EULP50019MBL	500 mm	19 mm	350 mm	Matte Black	£43.68	£37.44
EULP60032MBL	600 mm	32 mm	450 mm	Matte Black	£43.68	£37.44

*Price based on an order quantity of 5 (EULP50019MBL).

CRL Cut Resistant Level 5 Wrist Guards

- Our best value wrist guard
- Can be worn on either arm
- Loop and hook fastening
- Durable and comfortable
- BS EN 388 X-5-X-3
- Sold by the pair

WAS ~~£16.66~~
NOW FROM ONLY
£14.16*
EACH



Cat. No.	Length	1	12
0601	152 mm	£15.94	£14.16
06012	203 mm	£16.89	£15.01

*Price based on an order quantity of 12 (0601).

CRL Premium Latex Coated Cut Level E Glove Made With Kevlar® & Steel

- Extremely high ISO Cut level E
- Premium textured latex palm coating offers excellent grip in dry and wet applications
- Protection against abrasion and puncture
- Sanitised® hygiene function
- Made with DuPont™ Kevlar® & Steel
- EN407 tested and achieves contact heat level 2 (250 degrees)
- EN388-2016 rating 4X43E

WAS ~~£5.90~~
NOW FROM ONLY
£5.31*
EACH



Cat. No.	Size	1	20
0625A	Small	£6.21	£5.31
0626A	Medium	£6.21	£5.31
0627A	Large	£6.21	£5.31
0628A	Extra Large	£6.21	£5.31

*Price based on an order quantity of 20.

CRL Sandblast Kits for Safety Glass Marking

WAS £47.34
NOW FROM ONLY
£42.61*
EACH

Make sure your safety glass is marked as European standard requirements with our sandblasting kits. Significantly faster than using transfers and etching methods.

CRL Blast Pack Safety Marking Kit

- For sandblasting safety glass lettering
- Custom stencils made to own design
- Pistol requires compressed air
- Recommended blasting grit 80/120 grit (product code 1512)
- Lettering contained in 25 mm circle
- Kit comes complete with blast pistol, one custom made brass stencil, stencil holder, retaining ring, grit collection bag and 2.5 kgs of blasting agent
- Parts can also be ordered separately



15075B



15060

Cat. No.	Description	1	5
15075B	Blast kit complete with one custom stencil	£230.81	-
15060	Custom brass stencil	£52.00	£42.61

*Price based on an order quantity of 5 (15060).

CRL Detailed Safety Blasting Machine

- For sandblasting safety glass lettering
- Custom made stencils made to own design
- Kit requires compressed air
- Recommended blasting grit 220 grit (product code 2211)
- Lettering contained in 20 mm circle
- Detailed lettering with logo possible in your custom design

WAS £131.54
NOW FROM ONLY
£111.81*
EACH



2202

22021

Cat. No.	Description	1	6
2202	Detailed safety blasting machine	£940.82	-
22021	Custom made stencils (pack of 5)	£191.36	-
22025	One off initial die charge per design	£297.68	-
2211	220 grit blasting agent 25 kgs	£130.48	£111.81

*Price based on an order quantity of 6 (2211).

CRL Aluminium Tape with Liner

- Protects the back of the mirror against moisture ingress

WAS ~~£37.31~~
NOW FROM ONLY
£33.58*
EACH



Cat. No.	Description	Size	1	10	25
2108600	Standard - 30 Micron	600 mm x 45 m	£39.18	£36.16	£33.58

*Price based on an order quantity of 25.

CRL Mirabac Polypropylene Mirror Backing

- Keeps glass fragments together should mirror accidentally break, reducing the chance of personal injury
- Ready to use and easy-to-apply
- Tested to BS EN 12600
- Class 2B2
- 60 Micron

WAS ~~£20.96~~
NOW FROM ONLY
£18.86*
EACH



Cat. No.	Roll Size	1	10
21051	300 mm x 100 m	£21.13	£18.86
21052	450 mm x 100 m	£31.39	£28.03
21053	604 mm x 100 m	£41.92	£37.42

*Price based on an order quantity of 10 (21051).

CRL Sealant Finishing Tool

- Lightweight and flexible, simplifies tooling of sealants
- Titanium catalyst material will not stick to silicone or other sealants
- 83 mm x 89 mm x 5 mm

WAS ~~£2.90~~
NOW ONLY
£2.47*
EACH



Cat. No.	Description	1
55BSS	Sealant Finishing Tool	£2.47

*Price based on an order quantity of 1.

CRL MS Polymer Mirror Fix

- High quality professional mirror and painted glass adhesive developed with MS Polymer hybrid technology
- Adheres without the use of primer to most non-porous substrates
- Free of isocyanates, solvents, silicones and plasticiser
- No shrinkage
- UV, water, weather and mould resistant
- Mirrors should be mechanically supported while the adhesive is curing
- Colour: White
- 290 ml cartridge
- 12 per case



~~WAS £4.07~~
NOW FROM ONLY
£3.45*
 EACH

Cat. No.	Colour	1	60	120
EGMSF1X	White	£4.22	£3.81	£3.45

*Price based on an order quantity of 120.

CRL EG310ULTRA Complete Adhesive

- MS Polymer based
- Neutral curing and odourless
- Cures with atmospheric moisture
- Super-fast bonding of mirrors, glass, wood, composite panels and metal to a range of substrates
- Free of silicone and isocyanides
- 290 ml cartridge
- 12 per case



~~WAS £4.01~~
NOW FROM ONLY
£3.60*
 EACH

Cat. No.	Description	1	120
EG310ULTRA	Complete Adhesive	£3.94	£3.60

*Price based on an order quantity of 120.

CRL Neutral Cure Construction Silicone

- Neutral cure, low modulus silicone
- Versatile sealant
- Cures under the influence of humidity to form a durable elastic rubber seal
- Specifically developed for durable elastic sealing of expansion joints in concrete, brickwork, curtain wall constructions, kitchens, bathrooms, showers, industrial applications and glazing systems
- UV, water, weather and mould resistant
- Available in clear, black and white
- 300 ml cartridge
- 12 per case



~~WAS £3.58~~
NOW ONLY
£2.69*
 EACH

Cat. No.	Colour	1
CRLNCSC	Clear	£2.69
CRLNC SW	White	£2.69

*Price based on an order quantity of 1.

CRL Blue Transport Pads

- Medium density
- Low-tack, pressure sensitive, adhesive
- Leaves no adhesive residue or ghosting marks
- 23 mm x 17 mm x 3 mm

~~WAS £9.04~~
NOW FROM ONLY
£7.68*
 EACH

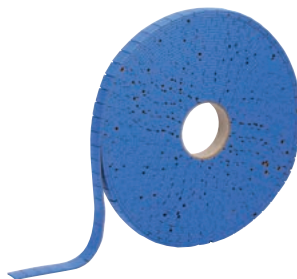

Cat. No.	Quantity	1	5	12	24
1407E	1,000 Roll	£8.18	-	£7.91	£7.68
1407LOG10	10,000 Roll	£60.32	£54.84	-	-

*Price based on an order quantity of 24 (1407E).

CRL Large Red Transport Pads

- Only 2 mm thick but highest density of all pads 600 kgs/M³
- Low-tack, pressure sensitive, adhesive
- U.V. and temperature resistant
- 50mm x 25 mm

~~WAS £29.13~~
NOW ONLY
£19.90*
 EACH

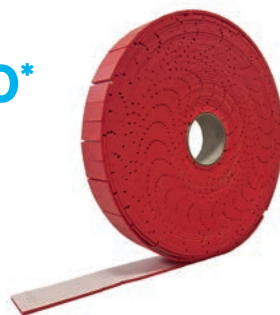

Cat. No.	Quantity	1
1407R4MM5025	1,000 Roll	£19.90

*Price based on an order quantity of 1.

CRL Glass and Mirror Cleaner

- A long time favourite of the glass industry
- Pleasant aroma
- 600 ml can

~~WAS £2.15~~
NOW FROM ONLY
£1.94*
 EACH



Cat. No.	Description	12	24	60
EB1701	Glass Cleaner	£2.48	£2.21	£1.94

*Price based on an order quantity of 60.

CRL Blue Surface Protection Film

- 40 micron blue film
- Adhesive free
- No residue
- Static hold
- Prevents scratches
- 1,000 m length

~~WAS £210.85~~
NOW ONLY
£189.77*
 EACH



Cat. No.	Width	1
21S1800B	1,800 mm	£189.77

*Price based on an order quantity of 1.

CRL Cerium Oxide

- Premium cerium oxide for fast stock removal
- Use with Felt Polishing Bobs 1323 (pictured below) in a power drill for scratch removal



~~WAS £24.51~~
NOW FROM ONLY
£22.06*
 EACH

Cat. No.	Contents	1	20
1222A	1 kg	£28.80	£22.06

*Price based on an order quantity of 20.

CRL Polishing Bob

- Will remove light scratches and water deposits from glass using any electric drill or power tool with a standard chuck



~~WAS £47.64~~
NOW FROM ONLY
£42.88*
 EACH

Cat. No.	Description	1	10
1323	Polishing Bob	£52.25	£42.88

*Price based on an order quantity of 10.

CRL Complete Polishing Head Assembly

- Used for light scratch removal
- Can be used with a cordless drill
- Consists of a 38.1 mm thick x 76 mm diameter wool felt wheel, aluminium adapter plate, and a 6 mm diameter shank



~~WAS £46.76~~
NOW ONLY
£42.08*
 EACH

Cat. No.	Description	1
5703	Complete Polishing Head Assembly	£42.08

*Price based on an order quantity of 1.

CRL Lifting Grab

- Glass sheet lifting pincer grab
- Capable of lifting individual glass sheets between 3 mm to 18 mm thickness
- Operated by over head crane
- 500 kg lifting capacity

~~WAS £1570.00~~

NOW ONLY

£1413.00*

EACH



Cat. No.	Description	1
5940	Lifting Grab	£1413.00

*Price based on an order quantity of 1.

CRL Wood's Powr-Grip® Vacuum Cup

- 203 mm diameter pad
- Check valve allows re-pumping without loss of remaining vacuum
- Release valve lever permits quick and complete release
- Fast attachment on smooth, non-porous flat surfaces
- Red-line indicator warns user of any vacuum loss
- Supplied with protective carrying case
- 57 kg lifting capacity

~~WAS £38.96~~

NOW FROM ONLY

£35.06*

EACH



N4950

N4000

Cat. No.	Description	1	4
N4000	ABS Handle Vacuum Cup	£38.25	£35.06
N4950	Metal Handle Vacuum Cup	£72.84	£66.76

*Price based on an order quantity of 4 (N4000).



CRL OTTOVAC Battery Operated Suction Cup

- Portable electric vacuum cup
- 1 Step push button operation
- Automatic on/off sensor
- Uses 4 "AA" 1.5V Alkaline batteries
- Parallel and perpendicular holding force of up to 150kg
- Service life: 10,000 times or 800 hours
- Net weight with battery: 1.2 kg
- Working temperature 0-60 C (32-140 F)



~~WAS £128.22~~

NOW ONLY

£110.00*

EACH

Cat. No.	Description	1
CRLOTTOVAC	Battery Operated Suction Cup	£110.00

*Price based on an order quantity of 1.

CRL 203 mm Pump-Action Vacuum Lifter For Curved Glass

- Designed primarily for lifting curved architectural glass
- Excellent also for thin, flexible materials
- Red-line indicator warns user of any vacuum loss
- 56 kg lifting capacity

~~WAS £31.33~~
NOW FROM ONLY
£28.20*
 EACH



Cat. No.	Description	1	4	20
S109	Vacuum Lifter For Curved Glass	£33.83	£30.75	£28.20

*Price based on an order quantity of 20.

CRL Aluminium Triple Pad Suction Lifter

- 114 mm diameter pads
- Sturdily built traditional design aluminium frame
- Three suction pads individually operated
- 100 kg lifting capacity



~~WAS £35.12~~
NOW ONLY
£29.85*
 EACH

Cat. No.	Description	1
05063PL	Triple Pad Suction Lifter	£29.85

*Price based on an order quantity of 1.

CRL Octopus Lifter with Gauge

- 150W Single pad suction lifter
- Built in pressure gauge
- Includes plastic carrying case
- 150 kg lifting capacity



~~WAS £110.14~~
NOW FROM ONLY
£49.99*
 EACH

Cat. No.	Description	1
0510	Octopus Lifter with Gauge	£49.99

*Price based on an order quantity of 1.

CRL Wood's Powr-Grip® Vacuum Lifting Frames

- Cord-free operation with on-board gel cell battery
- 280 mm diameter lipped pads
- Locks in place every quarter turn
- Three configurations all from the same unit
- Load movement: manual rotation 360° edgewise with automatic locking at each 1/4 revolution, assisted manual tilt 90° between upright and flat
- Dual vacuum system
- 12V DC
- 320 kg lifting capacity

See more details at crlaurence.co.uk



EUMRTA811LDC3



EUMRTA811LDC3



EUMRT411LDC2

WAS £5993.54
NOW FROM ONLY
£5394.19*
EACH



Cat. No.	Description	Lifting Capacity	1
EUMRT411LDC3	D.C. Manual Rotator/Tilter - 4 pads	320 kg	£5394.19
EUMRTA811LDC3	High-Flow D.C. Quadra Tilt Rotator - 8 pads	635 kg	£7357.43

*Price based on an order quantity of 1 (EUMRT411LDC3).

CRL Wood's Powr-Grip® Single Channel D.C. Vacuum Lifting Frame

- Four 280 mm diameter lipped pads
- 180° edgewise rotation
- 90° tilt, vertical to flat
- Automatic 'self-test' function ensures that the cups are safely loaded
- High holding strength and safe to use due to the dual-circuit suction system
- 12V DC
- 320 kg lifting capacity

See more details at crlaurence.co.uk



WAS £3686.01
NOW ONLY
£3317.41*
EACH



Cat. No.	Description	1
EUP11104DCO	Single Channel D.C. Vacuum Lifting Frame	£3317.41

*Price based on an order quantity of 1.



CRL Single Edge Razor Blades

- Our most popular single edge blade
- Precision honed surgical steel edges
- Individually wrapped to protect the edge
- Multiple uses
- 100 per box

~~WAS £4.50~~
NOW FROM ONLY
£3.80*
EACH



PRICE PER BOX OF 100 BLADES

Cat. No.	Description	1	5	10	50	100
51S	Single Edge Razor Blades	£6.80	£6.00	£5.00	£4.20	£3.80

*Price based on an order quantity of 100 boxes.

CRL Standard Vinyl Roller Tool

- Ideal for inserting all types of flat spline and roll-in gaskets
- Made from solid aluminium with a hard coat anodised finish
- Knurl diamond grip and a ball bearing wheel

~~WAS £9.90~~
NOW ONLY
£8.91*



Cat. No.	Length	1
VR04	279 mm	£8.91

*Price based on an order quantity of 1.

CRL Aluminum No-Draft Speak-Thru

- Eliminates drafts
- Theft-proof locking device
- Easy-to-install
- Designed to allow audible transmission of voice requests at ticket windows, box offices, and more
- Prevent tampering from the outside, and stop drafts to the interior
- Each unit is individually boxed with gaskets and mounting screws for installation on glass from 6 mm to 12 mm thick
- 127 mm diameter

~~WAS £30.28~~
NOW FROM ONLY
£25.74*
EACH



Cat. No.	Finish	1	5	10
834A	Satin Anodised	£29.33	£26.92	£25.74

*Price based on an order quantity of 10.

CRL Alcohol Sanitiser

- Protective against harmful virus and bacteria
- Fast drying
- Proven hygiene aid for instant protection and safety

~~WAS £5.98~~
NOW FROM ONLY
£3.89*
EACH



OB1HS

OB1SS

Cat. No.	Description	1
OB1HS	500 ml Sanitiser Bottle	£3.98
OB1SS	400 ml Sanitiser Spray	£3.89

*Price based on an order quantity of 1 (OB1SS).

CRL Habit Fit Sintered Diamond Drill

- 85 mm Long
- More robust but slower cutting than electroplated type of drill
- European manufactured



WAS £27.42
NOW FROM ONLY
£21.94*
EACH

Cat. No.	Hole Diameter	1	5	10
100306H	6 mm	£28.33	£24.71	£21.94
100307H	7 mm	£32.00	£27.92	£24.78
100308H	8 mm	£32.00	£27.92	£24.78
100310H	10 mm	£35.55	£31.05	£27.55
100312H	12 mm	£42.94	£37.30	£32.96
100313H	13 mm	£39.22	£34.24	£30.37
100314H	14 mm	£39.22	£34.24	£30.37
100315H	15 mm	£48.50	£42.11	£37.24
100316H	16 mm	£43.67	£37.94	£33.52
100318H	18 mm	£44.26	£38.65	£34.26
100326H	26 mm	£56.62	£49.42	£43.82
100337H	37 mm	£74.40	£64.94	£57.63
100338H	38 mm	£74.40	£64.94	£57.63
100342H	42 mm	£73.41	£64.09	£56.85
100345H	45 mm	£81.74	£71.34	£63.29
100346H	46 mm	£81.74	£71.34	£63.29
100350H	50 mm	£108.30	£94.53	£83.86
100351H	51 mm	£88.05	£76.83	£68.16
100354H	54 mm	£92.49	£80.70	£71.62
100356H	56 mm	£66.55	£58.98	£52.97
100357H	57 mm	£68.17	£60.42	£54.26
100359H	59 mm	£71.90	£63.72	£57.22
100363H	63 mm	£78.58	£69.66	£62.54
100364H	64 mm	£115.97	£101.24	£89.82
100375H	75 mm	£138.79	£121.15	£107.47
100380H	80 mm	£144.42	£126.03	£111.78

*Price based on an order quantity of 10 (100306H).

CRL Diamond Drill Continental Fit

- European manufactured
- Belgian type 1/2" gas shank sintered
- 75 mm long



WAS £26.07
NOW FROM ONLY
£20.86*
EACH

Cat. No.	Hole Diameter	1	5	10
100605C	5 mm	£26.93	£23.50	£20.86
100606C	6 mm	£32.98	£28.64	£25.31
100607C	7 mm	£32.00	£27.92	£24.78
100608C	8 mm	£32.00	£27.92	£24.78
100609C	9 mm	£33.81	£29.51	£26.15
100610C	10 mm	£35.58	£31.07	£27.57
100612C	12 mm	£37.09	£32.38	£28.73
100614C	14 mm	£39.22	£34.24	£30.37
100615C	15 mm	£41.75	£36.42	£32.34
100616C	16 mm	£41.75	£36.42	£32.34
100618C	18 mm	£44.23	£38.62	£34.26
100620C	20 mm	£47.23	£41.19	£36.56
100622C	22 mm	£57.72	£50.12	£44.30
100623C	23 mm	£49.74	£43.43	£38.54
100625C	25 mm	£65.81	£57.15	£50.50
1006265C	26.5 mm	£62.22	-	-
100626C	26 mm	£65.81	£57.15	£50.50
100627C	27 mm	£56.54	£49.34	£43.78
100628C	28 mm	£59.54	£51.95	£46.07
100629C	29 mm	£60.64	£52.94	£46.99
100630CK	30 mm	£53.04	£46.41	£41.25
100631C	31 mm	£61.90	£54.04	£47.93
100637C	37 mm	£70.66	£61.69	£54.74
100639C	39 mm	£72.79	£63.52	£56.37
100642C	42 mm	£77.29	£67.46	£59.86
100643C	43 mm	£77.29	£67.46	£59.86
100647C	47 mm	£61.05	£53.28	£47.77
100648C	48 mm	£128.68	£112.30	£100.70
100649C	49 mm	£64.14	£56.12	£49.88
100650C	50 mm	£89.42	£78.07	£69.24
100658C	58 mm	£89.95	£80.96	£73.57
100661C	61 mm	£83.70	£73.23	£65.10
100662C	62 mm	£83.70	£73.23	£65.10
100663C	63 mm	£87.57	£76.62	£68.11
100664C	64 mm	£87.57	£76.62	£68.11

*Price based on an order quantity of 10 (100605C).

CRL Altea Series Shower Hinges

- Cover plates hide fixing screws for a sleek, modern appearance
- Square corner hinge design
- Self closes from approximately 60°
- Solid brass
- For 6 to 10 mm toughened safety glass

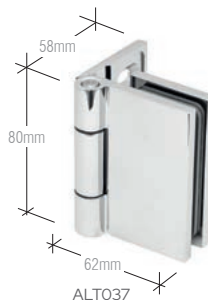

ALTO92



ALTI35



ALT180

~~WAS £31.84~~
NOW FROM ONLY
£27.06*
EACH

Maximum Capacities	6 mm to 10 mm glass	
	Weight	Door Width
Using two hinges	36 kg	710 mm
Using Three Hinges	54 kg	810 mm

Cat. No.	Description	Finish	1	18	54
ALTO37CH	Hinge, 90° Glass-Wall	Chrome	£35.11	£2787	£2706
ALTO37MBL	Hinge, 90° Glass-Wall	Matte Black	£37.09	£30.86	£28.59
ALTO92CH	Hinge, 90° Glass-to-Glass	Chrome	£51.47	£42.82	£39.60
ALT135CH	Hinge, 135° Glass-to-Glass	Chrome	£38.34	£31.93	£29.55
ALT180CH	Hinge, 180° Glass-to-Glass	Chrome	£46.74	£39.95	£35.94
ALT180MBL	Hinge, 180° Glass-to-Glass	Matte Black	£41.75	£34.80	£32.16

*Price based on an order quantity of 54 (ALTO37CH).

CRL Milano Hinges

- Precise closing feature to zero degrees
- Suitable for 6 to 8 mm toughened safety glass



MIL037CH



MIL045CH

~~WAS £20.22~~
NOW FROM ONLY
£17.19*
EACH

Cat. No.	Description	1	16
MIL037CH	Wall Mount Full Back Plate	£18.62	£1719
MIL045CH	135° Glass-to-Glass	£47.97	£44.29

*Price based on an order quantity of 16 (MIL037CH).

CRL Geneva Series Shower Hinges

- For 8 to 12 mm toughened safety glass
- Our most popular hinge series
- Square corner hinge design
- Self-centering when within 15° of closed position
- Construction: solid brass

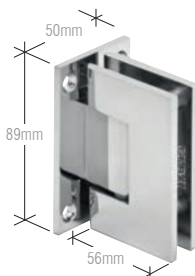

GEN037



GEN044



GEN180



GEN092CH

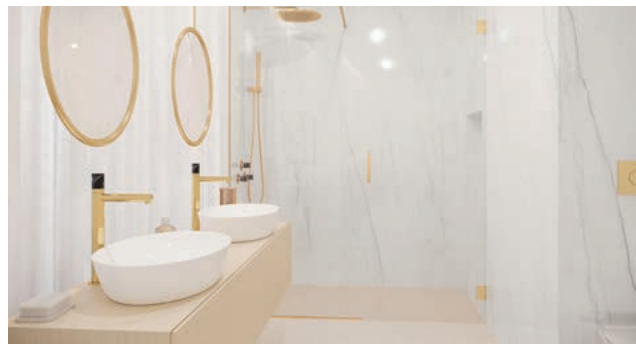

Maximum Capacities	8 mm to 12 mm glass	
	Weight	Door Width
Using Two Hinges	36 kg	711 mm
Using Three Hinges	54 kg	813 mm

~~WAS £34.97~~
NOW FROM ONLY
£29.72*
EACH

NOTE: Do not exceed maximum door weight or width when choosing proper quantity of hinges.

Cat. No.	Description	Finish	1	16
GEN037CH	Wall Mount Full Back Plate Hinge	Chrome	£32.55	£29.72
GEN037BN	Wall Mount Full Back Plate Hinge	Brushed Nickel	£32.55	£29.72
GEN037MBL	Wall Mount Full Back Plate Hinge	Matte Black	£43.77	£39.82
GEN037SB	Wall Mount Full Back Plate Hinge	Satin Brass	£42.95	£39.02
GEN044CH	Wall Mount Offset Back Plate Hinge	Chrome	£32.55	£29.72
GEN044BN	Wall Mount Offset Back Plate Hinge	Brushed Nickel	£32.55	£29.72
GEN044MBL	Wall Mount Offset Back Plate Hinge	Matte Black	£45.97	£41.79
GEN044SB	Wall Mount Offset Back Plate Hinge	Satin Brass	£39.02	£35.45
GEN180CH	180 Degree Glass-to-Glass Hinge	Chrome	£43.94	£39.92
GEN180BN	180 Degree Glass-to-Glass Hinge	Brushed Nickel	£43.94	£39.92
GEN180MBL	180 Degree Glass-to-Glass Hinge	Matte Black	£53.69	£48.78
GEN180SB	180 Degree Glass-to-Glass Hinge	Satin Brass	£52.63	£47.85
GEN092CH	90 Degree Glass-to-Glass Hinge	Chrome	£51.73	£46.94
GEN092BN	90 Degree Glass-to-Glass Hinge	Brushed Nickel	£69.16	£62.84
GEN092MBL	90 Degree Glass-to-Glass Hinge	Matte Black	£49.61	£45.09
GEN092SB	90 Degree Glass-to-Glass Hinge	Satin Brass	£77.59	£70.56

*Price based on an order quantity of 16 (GEN037CH).

CRL Altea Range Door Knobs

- 28 x 28 mm square door knob
- 12 mm diameter hole required
- Suitable for 6 mm to 10 mm toughened safety glass

~~WAS £6.45~~
NOW FROM ONLY
£5.48*
 EACH



Cat. No.	Description	Finish	1	10
ALTSDK1CH	Single Sided	Chrome	£6.09	£5.48
ALTSDK2BN	Back-to-Back	Brushed Nickel	£7.38	£6.64
ALTSDK2CH	Back-to-Back	Chrome	£7.62	£6.86

*Price based on an order quantity of 10 (ALTSDK1CH).

CRL Back-to-Back 40 mm Diameter Door Knob

- For use with 6-12 mm glass
- Brass body
- Chrome finish
- 12 mm diameter hole required

~~WAS £12.67~~
NOW FROM ONLY
£10.77*
 EACH

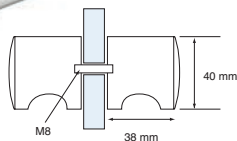

Cat. No.	Description	1	6
SDK140CHEU	Back-to-Back 40 mm Diameter Door Knob	£11.97	£10.77

*Price based on an order quantity of 6.

CRL Shower Door Knobs

- For 6 to 12 mm toughened safety glass
- 12 mm diameter hole required
- Available in several finishes

~~WAS £11.82~~
NOW FROM ONLY
£10.05*
 EACH



SDK140CH

SDK106CH

Cat. No.	Description	Finish	1	10	50
SDK140CH	Back-to-Back E-Z Grip Style	Chrome	£12.25	£11.00	£10.05
SDK140BN	Back-to-Back E-Z Grip Style	Brushed Nickel	£12.25	£11.00	£10.05
SDK140MBL	Back-to-Back E-Z Grip Style	Matte Black	£14.76	£13.23	£12.07
SDK140SB	Back-to-Back E-Z Grip Style	Satin Brass	£15.65	£13.80	£12.47
SDK106CH	Back-to-Back Contemporary Style Knob	Chrome	£17.88	£15.88	£14.33
SDK106BN	Back-to-Back Contemporary Style Knob	Brushed Nickel	£19.62	£17.43	£15.65
SDK106MBL	Back-to-Back Contemporary Style Knob	Matte Black	£24.46	£21.79	£19.57
SDK106SB	Back-to-Back Contemporary Style Knob	Satin Brass	£18.39	£16.37	£14.72

*Price based on an order quantity of 50 (SDK140CH).

CRL Euro Style Door Knobs

- For 8 to 10 mm toughened safety glass
- 10 mm hole required
- Available in solid brass or plated aluminium

~~WAS £14.13~~
NOW FROM ONLY
£12.01*
 EACH



Cat. No.	Finish	Material	1	60	120
EUSDK1CH	Chrome	Solid Brass	£16.96	£15.20	£12.06
EUSDK1BN	Brushed Nickel	Solid Brass	£18.60	£16.68	£13.24
EUSDK1MBL	Matte Black	Solid Brass	£15.05	£14.03	£12.01
EUSDK1SB	Satin Brass	Solid Brass	£14.42	£12.81	-

*Price based on an order quantity of 120 (EUSDK1MBL).

CRL SQ Series Square Back-To-Back Pull Handle

- For use with 6 to 12 mm toughened safety glass
- Features square tubing mitred corner to match with Geneva hinge style
- 203 mm centre-to-centre
- Without washers

Cat. No.	Finish	1	10	50
SQ8X8CH	Chrome	£45.35	£40.79	£37.14
SQ8X8BN	Brushed Nickel	£45.35	£40.79	£37.14
SQ8X8MBL	Matte Black	£49.24	£44.33	£40.31
SQ8X8SB	Satin Brass	£42.50	£38.25	£35.59

*Price based on an order quantity of 50 (SQ8X8SB).

WAS £41.87
NOW FROM ONLY
£35.59*
EACH



CRL SQ Series Square Back-To-Back Pull Handle

- For use with 6 to 12 mm toughened safety glass
- Square corners make this towel bar the ideal choice to match square cornered hinges
- 457 mm centre-to-centre
- No metal washers allows continuity of square profile

Cat. No.	Finish	1	10	50
SQ18X18CH	Chrome	£84.01	£74.73	£67.21
SQ18X18BN	Brushed Nickel	£84.01	£74.73	£67.21
SQ18X18MBL	Matte Black	£91.50	£81.42	£73.23
SQ18X18SB	Satin Brass	£143.18	£119.32	£102.29

*Price based on an order quantity of 50 (SQ18X18CH).

WAS £79.07
NOW FROM ONLY
£67.21*
EACH



CRL BM Series Back-To-Back Pull Handle

- For use with 6 to 12 mm toughened safety glass
- Our most popular back-to-back towel bar series
- 203 mm centre-to-centre
- Decorative metal washers also serve to cover any defect in hole in glass

Cat. No.	Finish	1	10	50
BM8X8CH	Chrome	£24.88	£22.27	£20.34
BM8X8BN	Brushed Nickel	£24.88	£22.27	£20.34
BM8X8MBL	Matte Black	£25.33	£22.79	£20.70
BM8X8SB	Satin Brass	£24.58	£22.14	£20.14

*Price based on an order quantity of 50 (BM8X8SB).

WAS £23.69
NOW FROM ONLY
£20.14*
EACH



CRL BM Series Back-to-Back Towel Bar

- For use with 6 to 12 mm toughened safety glass
- Our most popular back-to-back towel bar series
- 457 mm centre-to-centre
- Decorative metal washers also serve to cover any defect in hole in glass

Cat. No.	Finish	1	10	50
BM18X18CH	Chrome	£48.14	£43.38	£39.43
BM18X18BN	Brushed Nickel	£48.14	£43.38	£39.43
BM18X18MBL	Matte Black	£57.71	£52.02	£47.18
BM18X18SB	Satin Brass	£54.00	£51.30	£46.15

*Price based on an order quantity of 50 (BM18X18CH).

WAS £46.39
NOW FROM ONLY
£39.43*
EACH



CRL Clear Vinyl Bulb Seal

- Can be used on inswing and outswing doors
- Suggested gap: 6 to 8 mm
- 2.49 m stock length

~~WAS £4.95~~
NOW FROM ONLY
£4.21*
 EACH



Cat. No.	Glass Thickness	1	10	40
PCR8	8 mm	£5.02	£4.58	£4.21
PCR10	10 mm	£9.72	£8.82	£8.08

*Price based on an order quantity of 40 (PCR8).

CRL Ultra Clear Vinyl Bulb Seal

- Can be used on inswing and outswing doors
- Suggested gap: 6 to 8 mm
- 2.49 m stock length

~~WAS £11.44~~
NOW FROM ONLY
£4.90*
 EACH



Cat. No.	Glass Thickness	1
PCR10UC	10 mm	£4.90

*Price based on an order quantity of 1.

CRL Clear 'Y' Jamb Seal With Soft Leg

- Soft vinyl leg for quieter door closure
- For glass to glass applications
- 2.41 m stock length

~~WAS £7.69~~
NOW FROM ONLY
£6.54*
 EACH

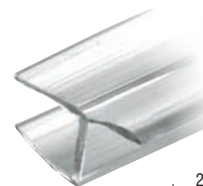

Cat. No.	Glass Thickness	1	10	40
PCC8	8 mm	£7.72	£7.20	£6.54
PCC10	10 mm	£11.95	£10.87	£10.20

*Price based on an order quantity of 40 (PCC8).

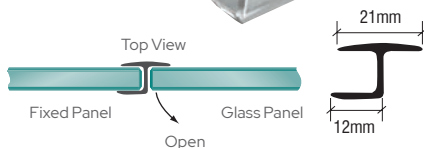

CRL Clear Co-Extruded Bottom Wipe with Drip Rail

- Length: 2.49 m
- Our most popular bottom sweep
- Snaps on bottom of door
- 45° drip rail assists in deflecting water back into the enclosure
- Suggested gap 8 mm
- Use monolithic toughened glass

~~WAS £5.73~~
NOW FROM ONLY
£4.87*
 EACH

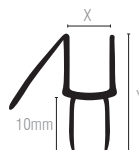

Cat. No.	Glass Thickness	1	10	40
P956WS	8 mm	£6.00	£5.34	£4.87
P990WS	10 mm	£7.93	£7.06	£6.45

*Price based on an order quantity of 40 (P956WS).

CRL Wall Mount Brackets

- Component to provide fixed panel support for enclosures not going to the ceiling
- Compatible with CRL support bars
- Several finishes available



WAS £6.43
NOW FROM ONLY
£5.47*
EACH

Cat. No.	Finish	1	6
S12CH	Chrome	£6.45	£5.87
S12BN	Brushed Nickel	£6.38	£5.77
S12MBL	Matte Black	£6.54	£5.47
S12SB	Satin Brass	£7.33	£6.57

*Price based on an order quantity of 6 (S12MBL).

CRL Support Bar U-Bracket

- Component to provide fixed panel support for enclosures not going to the ceiling
- Compatible with CRL support bars
- For use with S1, S2, or S80 Support Bar
- Use Monolithic Tempered Glass
- Several finishes available



Cat. No.	Finish	Glass Thickness	1	6
S4CH	Chrome	6-8 mm	£20.86	£18.86
S4BN	Brushed Nickel	6-8 mm	£21.80	£19.73
S4MBL	Matte Black	6-8 mm	£22.36	£18.67
S4SB	Satin Brass	6-8 mm	£18.73	£16.93
S5CH	Chrome	10-12 mm	£26.23	£23.72
S5BN	Brushed Nickel	10-12 mm	£21.82	£19.76
S5MBL	Matte Black	10-12 mm	£22.34	£18.64
S5SB	Satin Brass	10-12 mm	£33.07	£27.55

*Price based on an order quantity of 6 (S4SB).

WAS £19.92
NOW FROM ONLY
£16.93*
EACH

CRL Vertical Support Bracket

- Component to provide fixed panel support for floor to ceiling mount applications
- Compatible with CRL support bars
- For use with S1, S2, or S80 Support Bar
- Use Monolithic Tempered Glass
- Several finishes available



WAS £12.49
NOW FROM ONLY
£10.62*
EACH

Cat. No.	Finish	Glass Thickness	1	6
S910CH	Chrome	10-12 mm	£11.87	£10.80
S910BN	Brushed Nickel	10-12 mm	£11.87	£10.77
S910MBL	Matte Black	10-12 mm	£12.75	£10.62
S910SB	Satin Brass	10-12 mm	£13.56	£12.27

*Price based on an order quantity of 6 (S910MBL).

CRL Round Support Bar

- Component to provide fixed panel support
- Compatible with a large range of CRL brackets to meet your needs
- Size: 19 mm
- Length: 1 m



WAS £22.33
NOW FROM ONLY
£18.98*
 EACH

Cat. No.	Description	Finish	1	6
SICH	1 m Round Support Bar	Chrome	£21.27	£19.20
SIBN	1 m Round Support Bar	Brushed Nickel	£21.11	£19.13
SIMBL	1 m Round Support Bar	Matte Black	£22.67	£18.98
SISB	1 m Round Support Bar	Satin Brass	£24.29	£21.80

*Price based on an order quantity of 6 (SIMBL).

CRL Top Mount Clamps – Fixed Panel Square Clamp

- Made of duplex 2205 stainless steel
- Does not require holes in the glass
- Clamps contribute to 'all-glass' appearance
- Perfect for bracing glass partitions, windscreens, sound walls, and pool fencing panels
- For 10 to 12 mm monolithic toughened glass
- Larger leg version covers more wall surface

WAS £15.02
NOW FROM ONLY
£12.77*
 EACH



SGC037CH

Cat. No.	Description	Finish	1	10	50
SGC037CH	With Small Leg	Chrome	£15.94	£14.20	£12.77
SGC037BN	With Small Leg	Brushed Nickel	£15.94	£14.20	£12.77
SGC037MBL	With Small Leg	Matte Black	£19.86	£17.63	£15.93
SGC037SB	With Small Leg	Satin Brass	£20.48	£18.23	£16.41
SGC039CH	With Large Leg	Chrome	£22.92	£20.03	£17.83
SGC039BN	With Large Leg	Brushed Nickel	£23.95	£20.98	£18.66
SGC039MBL	With Large Leg	Matte Black	£23.77	£21.12	£19.27
SGC039SB	With Large Leg	Satin Brass	£24.61	£21.85	£19.65

*Price based on an order quantity of 50 (SGC037CH).



SGC039CH

CRL Aluminium Recessed U-Channel

- Available in 2.49 m lengths
- For 8 to 10 mm glass
- Ideal for recessing glass and creating the "all-glass" appearance
- Top of channel angled to assist with water deflection
- Top lip helps cover edge of tile



WAS £16.64
NOW FROM ONLY
£14.14*
 EACH

Cat. No.	Finish	1	10	40	80	120
SDCF38BA	Bright Anodised	£18.93	£17.70	£16.60	£15.61	£14.14
SDCF38BN	Brushed Nickel	£19.38	£18.06	£17.07	£15.93	£14.45

*Price based on an order quantity of 120 (SDCF38BA).

CRL Dry Glaze U-Channel With Vinyl for 8 and 10mm Glass

- Clear vinyls secure glass in channel and eliminate the need for messy silicone
- Recess in bottom channel hides caulk line
- DUC38 can be used with 8 mm glass where RV8DUC rigid vinyl is used (available separately)
- Individually packaged

~~WAS £23.49~~
NOW FROM ONLY
£19.97*
EACH

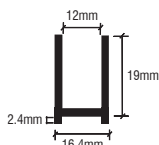

Complete by securing U-Channel



NOTE: glass is not included

Cat. No.	Finish	Length	Glass Thickness	1	10	50
DUC516BA	Bright Anodised	2.4 m	8 mm	£26.90	£24.23	£21.85
DUC516BN	Brushed Nickel	2.4 m	8 mm	£29.57	£26.86	£24.64
DUC516MBL9	Matte Black	2.5 m	8 mm	£30.74	£27.94	£25.64
DUC38BA	Bright Anodised	2.4 m	10 mm	£24.62	£22.15	£19.97
DUC38BN	Brushed Nickel	2.4 m	10 mm	£27.54	£25.07	£22.96
DUC38MBL9	Matte Black	2.5 m	10 mm	£27.54	£25.07	£22.96

*Price based on an order quantity of 50 (DUC38BA).

CRL Aluminium U-Channel for 6 to 8 mm Glass

- Available in 2.49 m lengths
- Wet glaze with clear silicone

~~WAS £11.91~~
NOW FROM ONLY
£10.12*
EACH

Cat. No.	Finish	1	10	40	80	120
SDCD516BA	Bright Anodised	£14.63	£13.20	£11.95	£11.32	£10.74
SDCD516BN	Brushed Nickel	£14.45	£13.57	£12.24	£11.63	£11.32
SDCD516MBL	Matte Black	£19.22	£17.34	£15.70	£14.86	£14.11
SDCD516SB	Satin Brass	£13.79	£12.44	£11.26	£10.67	£10.12
SDCD516BGA	Bright Gold Anodised	£25.53	£22.64	£20.41	£18.56	£17.03

*Price based on an order quantity of 120 (SDCD516SB).

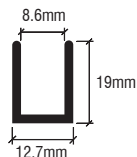
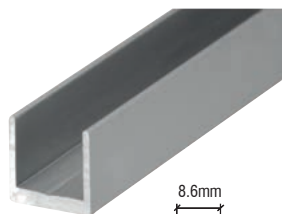

CRL Aluminium U-Channel for 10 mm Glass

- Wet glazed with clear silicone to secure glass
- Length: 2.49 m
- Depth: 19 mm

~~WAS £13.17~~
NOW FROM ONLY
£11.19*
EACH

Cat. No.	Finish	1	10	40	80	120
SDCD38BA	Bright Anodised	£14.76	£13.90	£12.51	£11.87	£11.50
SDCD38BN	Brushed Nickel	£15.84	£12.51	£11.87	£11.58	£11.25
SDCD38MBL	Matte Black	£16.71	£15.72	£14.14	£13.42	£13.01
SDCD38SB	Satin Brass	£17.54	£15.30	£13.66	£12.27	£11.19
SDCD38BGA	Bright Gold Anodised	£28.87	£25.64	£23.07	£21.00	£19.22

*Price based on an order quantity of 120 (SDCD38SB).

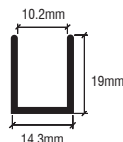
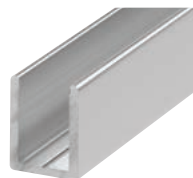

CRL Corner Profile

- To be used with 10 mm thick toughened glass
- 90 degree aluminium corner profile to be used with SDCD38 U-channel
- Wet glazed with clear silicone to secure glass
- None structural framing
- Used to create a complete frame look when using SDCD38 U-channel.
- Used with EUFB19 flat bar for a stylistic appearance.
- 2410 mm long

~~WAS £17.84~~
NOW FROM ONLY
£15.16*
 EACH

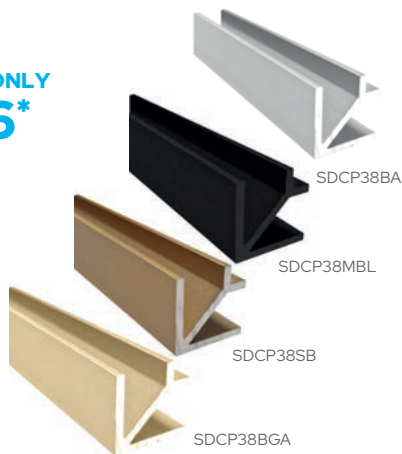

Cat. No.	Finish	1	10	20
SDCP38BA	Bright Anodised	£20.62	£17.94	£15.86
SDCP38MBL	Matte Black	£22.49	£19.56	£17.30
SDCP38SB	Satin Brass	£19.71	£17.14	£15.16
SDCP38BGA	Bright Gold Anodised	£21.00	£18.27	£16.16

*Price based on an order quantity of 20 (SDCP38SB).

CRL Aluminium Profile

- Flat aluminium profile
- Ideal for creating lattices on all-glass partition walls (loft-style)
- 19 mm wide, 1.5 mm thickness

~~WAS £4.33~~
NOW FROM ONLY
£3.68*
 EACH

Cat. No.	Finish	1	10	20
EUFB19MBL	Matte Black	£6.16	£5.13	£4.39
EUFB19SB	Satin Brass	£5.17	£4.31	£3.68
EUFB19BGA	Bright Gold Anodised	£5.45	£4.54	£3.88

*Price based on an order quantity of 20 (EUFB19SB).



CRL Wall Mounted Hinge Profile for 6 mm Toughened Glass

- Rise and fall hinge action
- Adjustable zero position
- No glass processing necessary
- Profile can be cut down to the required length
- Available with a wall; clearance of 55 mm or 74 mm
- Construction: Aluminium
- Hinge Swings: 90° in and 90° out (at factory set position)
- 2,200 mm length hinge profile
- Bright Anodised finish

~~WAS £98.52~~
NOW FROM ONLY
£83.74*
 EACH



Cat. No.	Description	Wall Clearance	Glass Thickness	1	6
WHP6CBA	Classic Wall Mounted Hinge	55 mm	6 mm	£91.36	£83.74
WHP6EBA	Expander Wall Mounted Hinge	74 mm	6 mm	£103.90	£95.24

*Price based on an order quantity of 6 (WHP6CBA).



CRL 6K Hydrophobic Surface Protection System for Glass and Stainless Steel

- Two Stage Process
- Nano-Technology
- Non-irritant
- UV stable for long life
- Abrasion resistant
- Long Lasting Coverage
- Hydrophobic protection
- Conforms to EN 45001



Stage one - pre-clean

Stage two - protect



Red pre-clean cloth

Blue protect cloth

Cat. No.	Description	Contents	1	6	10	50
PC6010	Stage one - pre-clean	100 ml	£4.92	£4.43		
PC6025	Stage one - pre-clean	250 ml	£9.08	£8.17		
PC6050	Stage one - pre-clean	500 ml	£12.66	£11.40		
PC6100	Stage one - pre-clean	1 Litre	£19.04	£17.14		
PCCL0TH	Red pre clean cloth	-	£1.37	-	£1.23	£1.13
6K6010	Stage two - protect	100 ml	£11.81	£10.63		
6K6025	Stage two - protect	250 ml	£26.29	£23.66		
6K6050	Stage two - protect	500 ml	£47.96	£42.36		
6K6100	Stage two - protect	1 Litre	£87.85	£79.07		
6KCL0TH	Blue protect cloth	-	£1.31	-	£1.17	£1.07

*Price based on an order quantity of 6 (PC6010).

WAS £4.92
NOW FROM ONLY
£4.43*
EACH

CRL TAPER-LOC® Square Base Shoe

- Surface mounted base shoe
- Safety-seal compatible
- Stock length: 3 m
- Depth: 12.7 mm
- Centre-to-Centre: 300 mm
- Pre-drilled
- Finish: Brushed Nickel

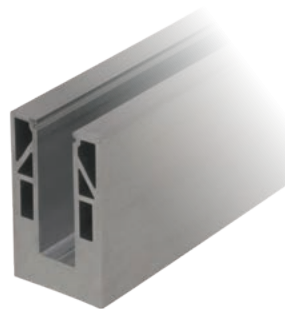

Cat. No.	Use	Glass Thickness	Hole Size	Counter Bore	1
9BL21DBN	Commercial	21.52 mm	20 mm	31.7 mm	£191.75
8B58DBN	Residential	15 mm	14.3 mm	22 mm	£194.58
9BL68DBN	Residential	17.52 mm	20 mm	31.7 mm	£249.39
8B34DBN	Commercial	19 mm	14.3 mm	22 mm	£153.81
9BL25DBN	Commercial	25.52 mm	20 mm	31.7 mm	£219.20

*Price based on an order quantity of 1 (8B34DBN).

~~WAS £170.90~~
NOW FROM ONLY
£153.81*
 EACH

CRL TAPER-LOC® Flange Fix Base Shoe

- Allows quick and easy slab edge installations
- Taper-Loc® can now be installed flush with the slab edge and from the safe side
- Uses existing innovative Taper-Loc® installation system, complete with safety side gasket
- Tested to 0.74KN With 21.52mm toughened laminated glass in accordance with BS6180-2011
- No need for cladding, supplied in a Brushed Nickel Anodised finish
- Safety seal gasket for safe side installations supplied on request



~~WAS £219.50~~
NOW FROM ONLY
£197.55*
 EACH

Cat. No.	Description	1	6
9BL21FLBN	Flange Fix Base Shoe	£215.51	£197.55

*Price based on an order quantity of 6.

CRL Kwixset® Expanding Cement

- Versatile high strength cement for setting glass panels in to base shoe as an alternative to using TAPER-LOC®
- Kwixset® for exterior and interior applications
- Great for setting core mount stanchions for vertical posts
- Expands as it sets
- Fast setting, they will not shrink or crack when used as directed
- Simply mix with water
- CRL recommends consulting with the glass fabricator prior to wet setting laminated toughened glass

~~WAS £73.64~~
NOW FROM ONLY
£66.28*
 EACH



Cat. No.	Size	1	4
KWX50	22.6 kg	£69.56	£66.28

*Price based on an order quantity of 4.

CRL 48.3 mm Diameter Cap Rail

- Connects to a variety of fabricated corners and end caps
- 316 grade stainless steel

WAS £60.82
NOW FROM ONLY
£54.74*
EACH

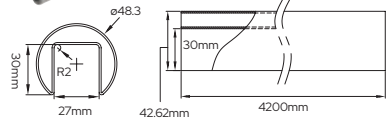

Cat. No.	Finish	Length	1	6
EUGR20BS	Brushed Stainless Steel	3 m	£59.72	£54.74
EUGR20BS14	Brushed Stainless Steel	4.2 m	£64.19	£58.83

*Price based on an order quantity of 6 (EUGR20BS).

CRL Vinyl Insert

- Use with 48.3 mm cap rail and CRL square cap rail
- Cap rail vinyl

Cat. No.	Glass Thickness	Length	1	6
EUGR6PV	15 mm	3 m	£15.14	£13.46
EUGR6PV14	15 mm	4.2 m	£27.45	£24.42
EUGR7PV	19 mm	3 m	£9.79	£8.69
EUGR7PV14	19 mm	4.2 m	£14.72	£12.91
EUGR68PV	17.52 mm	3 m	£13.18	£11.73
EUGR68PV14	17.52 mm	4.2 m	£17.61	£15.65
EUGR21PV	21.52 mm	3 m	£9.88	£8.80
EUGR21PV14	21.52 mm	4.2 m	£14.84	£13.19

*Price based on an order quantity of 6 (EUGR7PV).



WAS £9.65
NOW FROM ONLY
£8.69*
EACH

CRL 3 m Hand Rail Tubing

- For 50.8 mm post kits
- Sold per 3 metre length
- Used with European post kits
- 1.2 mm material thickness
- 316 grade stainless steel
- Available in brushed and polished stainless steel

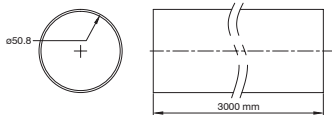

Cat. No.	Finish	Length	1	6
EUHR20BS	Brushed Stainless Steel	3 m	£48.52	£44.48
EUHR20BS14	Brushed Stainless Steel	4.2 m	£52.55	£48.17
EUHR20PS	Polished Stainless Steel	3 m	£55.22	£50.62

*Price based on an order quantity of 6 (EUHR20BS).



WAS £49.42
NOW FROM ONLY
£44.48*
EACH



For interior and exterior applications

CRL 50.8 mm Post Kits and Accessories

- 50.8 mm post kits
- 316 grade stainless steel
- Sold as a complete post kit
- Supplied with 8.76 mm, 10 mm, 10.76 mm and 12 mm gaskets and support plate
- Available in brushed and polished stainless steel
- 2.5 mm material thickness
- 12 mm gaskets pre-installed in clamps (not applicable to EUPR42BBS)
- Overall height including 50.8 mm diameter handrail is 1,105 mm

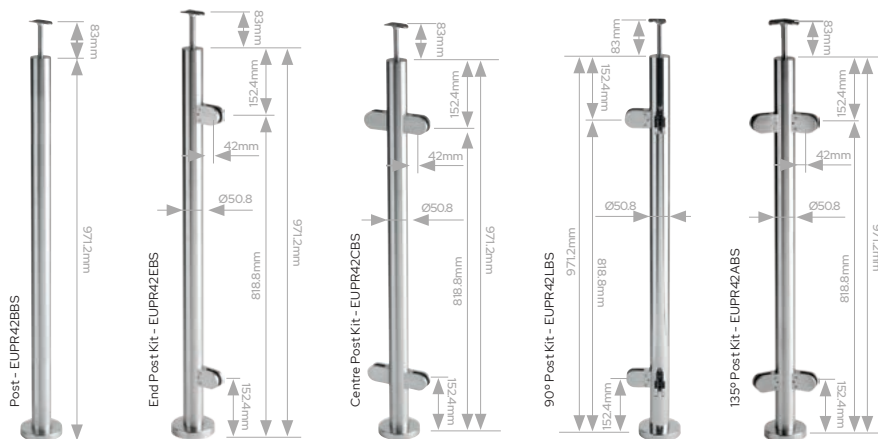

Cat. No.	Description	Finish	1
EUPR42ABS	135° Post Kit	Brushed Stainless Steel	£90.06
EUPR42APS	135° Post Kit	Polished Stainless Steel	£93.37
EUPR42BBS	Blank Post	Brushed Stainless Steel	£44.78
EUPR42CBS	Centre Post Kit	Brushed Stainless Steel	£86.18
EUPR42CPS	Centre Post Kit	Polished Stainless Steel	£95.20
EUPR42EBS	End Post Kit	Brushed Stainless Steel	£59.66
EUPR42EPS	End Post Kit	Polished Stainless Steel	£61.98
EUPR42LBS	90° Post Kit	Brushed Stainless Steel	£87.67
EUPR42LPS	90° Post Kit	Polished Stainless Steel	£85.81

*Price based on an order quantity of 1 (EUPR42BBS).

~~WAS £47.77~~
NOW FROM ONLY
£44.78*
EACH



CRL POSlone

One-Side-Fit Frameless Glass Balustrade System Designed With Installers In Mind

CRL POSlone is our most technically advanced one-side-fit aluminium balustrade system. POSlone has all the benefits and strength of Posiglaze but now it's easier and safer to install. The system is compatible with a large range of finishing accessories including 90° and 135° pre-fabricated corners and Balcony Seal.

It has been tested to BS6180:2011 up to 1.50kN suitable for residential and commercial applications.

- Tested with glass panels up to 1200 mm high.
- Available in Silver and Black.
- Tested to BS 6180:2011.



CRL POSlone is ideal for residential and commercial balustrade installations.

ONE-SIDE FIT

Simple to fit and adjust thanks to its patented screw-clamp technology. One-side-fit reduces cost and safety equipment and glass can easily be removed and replaced.

LIGHTWEIGHT AND STRONG

Precision engineered using extruded aluminium with a geometrically hollowed out core providing an incredible strength to weight ratio anodised to 25 microns.

APPROPRIATE FOR RESIDENTIAL AND COMMERCIAL

With 0.36kN to 1.50kN force loading capability, POSlone is suitable for a wide range of installations.

SUITABLE FOR USE ON UNEVEN SURFACES

The one-side-fit screw-clamp technology provides a 20 mm adjustment angle on both sides of the glass, enabling perfect alignment of each glass panel.

QUALITY ENGINEERING

Tested to BS6180:2011 - 1.50kN for private residential and small commercial applications.

GLASS THICKNESSES

- 12, 15 and 19 mm toughened monolithic glass.
- 13.5, 17.5 and 21.5 mm toughened laminated glass.
- To achieve 1.5 kN line load use 19 mm toughened glass or 21.5 mm Sentry Glass.



TESTED TO
BS 6180:2011

WAS £207.22
NOW FROM ONLY
£165.78*
EACH

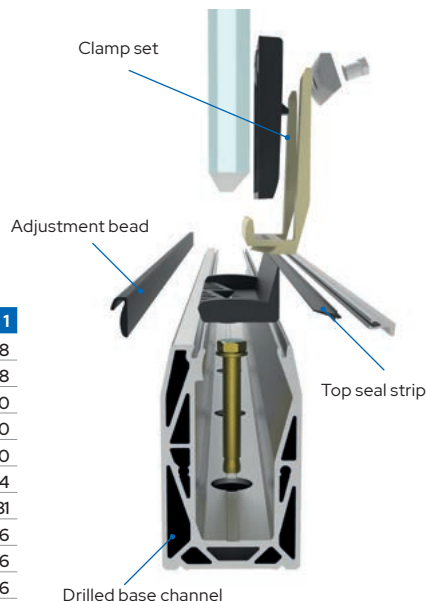

Cat. No.	Description	Colour	1
EPODSV	Drilled Base Channel	Silver	£165.78
EPODBL	Drilled Base Channel	Black	£172.98
EPO15SET	15 mm clamp set	-	£48.80
EPO17SET	17.52 mm clamp set	-	£48.80
EPO19SET	19 mm clamp set	-	£48.80
EPO21SET	21.52 mm clamp set	-	£46.84
EPOABL	Adjustment bead for 21.52-23 mm glass	-	£10.81
EPOABM	Adjustment bead for 19 mm glass	-	£11.26
EPOABS	Adjustment bead for 12-17.52 mm glass	-	£11.26
EPOTSBL	Top seal strip	Black	£8.66
EPOSSV	Top seal strip	Silver	£7.22

*Price based on an order quantity of 1 (EPODSV).



Manchester | Charles Babbage Avenue, Kingsway Business Park, Rochdale, OL16 4NW, England



Stuttgart | Boschstrasse 7 D-74360 Ilsfeld, Germany



With daily despatches from our 110,000 square foot facilities your order can be with you quicker than ever.

Orders are shipped daily from the CRL Warehouse via our trusted carriers. Orders are generally received next day.

See our service and shipping information at www.crlaurence.co.uk