



GREAT DEALS!

HURRY – ENDS 31st DECEMBER 2020

PROTECTIVE SCREEN AND TRANSACTION HARDWARE

SEE PAGES 2-7

FOR ALL THE LATEST OFFERS, SIGN UP TO OUR NEWSLETTER AT [CRLNEWS.CO.UK](https://www.crlnews.co.uk)

PROTECTIVE SCREENS | GLASS HANDLING | SEALANTS & ADHESIVES
SHOWER HARDWARE | RAILING HARDWARE & **MUCH MORE!**





CRL PPS SERIES

PORTABLE PARTITION SCREEN FITTING

PORTABLE PARTITION SCREEN FITTING

- Support for Tempered or Laminated Glass or Acrylic screens
- Adjustable thickness 6 mm – 10 mm
- Anti-slip base
- Recommended: 2 Fittings / metre, 3 Fittings / 1.5 metre

FROM ONLY

£18.15*
each

PPS1000
Screen Height
100 cm

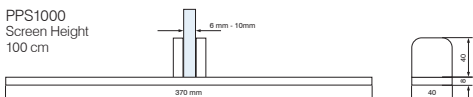

PPS800
Screen Height
80 cm

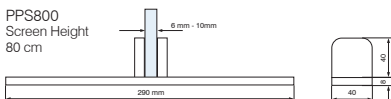

PPS600
Screen Height
60 cm

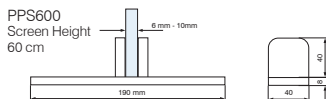

CAT. NO.	SCREEN HEIGHT	FINISH	1	10	40
PPS600MBL	Up to Max 600 mm	Matte Black	£21.45	£19.66	£18.15
PPS600BS	Up to Max 600 mm	Brushed Stainless	£23.04	£21.12	£19.49
PPS800MBL	Up to Max 800 mm	Matte Black	£24.59	£22.54	£20.81
PPS800BS	Up to Max 800 mm	Brushed Stainless	£25.74	£23.60	£21.78
PPS1000MBL	Up to Max 1000 mm	Matte Black	£26.46	£24.25	£22.39
PPS1000BS	Up to Max 1000 mm	Brushed Stainless	£26.89	£24.65	£22.76

*Minimum order: 1 each. Price based on an order quantity of 40 (PPS600MBL).

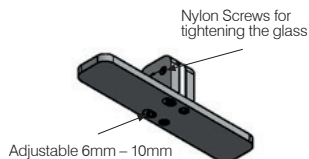



CRL FSMS SERIES

FLOOR SUPPORTED MOVEABLE SCREENS



FROM ONLY

£377.17*
each

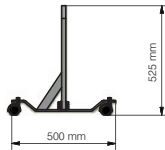

BASE SUPPORTED SCREEN FITTING

- Pivoting wheels for easier manoeuvrability
- Safety brake on wheels
- Supports glass widths of 1300 mm or 1800 mm
- For a glass thickness of 8 mm or 10 mm
- For glass with a maximum height of 1.8 m
- Suitable for Laminated Glass
- No fabrication required
- Matte silver, matte black and matte white lacquered finishes

CAT. NO.	DESCRIPTION	1	10	40
FSMS1300MW	White - 1300 mm Width	£445.91	£408.74	£377.17
FSMS1300MBL	Black - 1300 mm Width	£445.91	£408.74	£377.17
FSMS1300MS	Silver - 1300 mm Width	£445.91	£408.74	£377.17
FSMS1800MW	White - 1800 mm Width	£445.91	£408.74	£377.17
FSMS1800MBL	Black - 1800 mm Width	£445.91	£408.74	£377.17
FSMS1800MS	Silver - 1800 mm Width	£445.91	£408.74	£377.17

* Minimum order 1 each. Price based on an order quantity of 40.



FROM ONLY

£248.38*
each

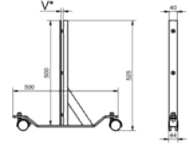

GLASS CLAMP SCREEN FITTING

- Pivoting wheels for easier manoeuvrability
- Safety brake on wheels
- For a glass thickness of 6 mm or 10 mm
- For glass with a maximum height of 1.8 m
- Supports maximum glass width of 2000 mm
- For Tempered or Tempered Laminated Glass
- Glass fabrication required
- Matte silver, matte black and matte white lacquered finishes

CAT. NO.	DESCRIPTION	1	10	40
FSMSGCMW	White - 1800 mm Height	£293.65	£269.17	£248.38
FSMSGCMBL	Black - 1800 mm Height	£293.65	£269.17	£248.38
FSMSGCMS	Silver - 1800 mm Height	£293.65	£269.17	£248.38

* Minimum order 1 each. Price based on an order quantity of 40.



ALUMINIUM PARTITION POSTS - 12"

- 5 standard configurations – end, centre, corner, 3-way, 4-way
- Aluminum tubing with full length channels for 6 mm thick glass
- Top cap and mounting base included
- Use Monolithic Toughened Glass

FROM ONLY

£25.94*

each



END



CENTRE



90°
CORNER



3-WAY



4-WAY

CAT. NO.	DESCRIPTION	1	12
D990A12E	Satin Anodised - End Part	£28.31	£25.94
D990BL12E	Matte Black - End Part	£42.80	£36.68
D990A12C	Satin Anodised - Centre Part	£32.73	£29.96
D990BL12C	Matte Black - Centre Part	£52.61	£45.10
D990A12CR	Satin Anodised - Corner Part	£32.73	£29.96
D990BL12CR	Matte Black - Corner Part	£52.61	£45.10
D990A123W	Satin Anodised - 3 Way Part	£37.22	£34.06
D990BL123W	Matte Black - 3 Way Part	£61.98	£53.12
D990A124W	Satin Anodised - 4 Way Part	£41.48	£38.01
D990BL124W	Matte Black - 4 Way Part	£71.94	£61.66

* Minimum order 1 each. Price based on an order quantity of 12 (D990A12E)

ALUMINIUM PARTITION POSTS - 18"

- 5 standard configurations – end, centre, corner, 3-way, 4-way
- Aluminum tubing with full length channels for 6 mm thick glass
- Top cap and mounting base included
- Use Monolithic Toughened Glass

CAT. NO.	DESCRIPTION	1	12
D990A18E	Satin Anodised - End Part	£31.21	£28.61
D990BL18E	Matte Black - End Part	£43.56	£37.33
D990A18C	Satin Anodised - Centre Part	£36.68	£33.61
D990BL18C	Matte Black - Centre Part	£53.95	£46.24
D990A18CR	Satin Anodised - Corner Part	£36.68	£33.61
D990BL18CR	Matte Black - Corner Part	£53.95	£46.24
D990A183W	Satin Anodised - 3 Way Part	£41.70	£38.24
D990BL183W	Matte Black - 3 Way Part	£63.89	£54.77
D990A184W	Satin Anodised - 4 Way Part	£46.78	£42.89
D990BL184W	Matte Black - 4 Way Part	£63.89	£54.77

* Minimum order 1. Price based on an order quantity of 12 (D990A18E)

FROM ONLY

£28.61*
each

ALUMINIUM PARTITION POSTS - 24"

- 5 standard configurations – end, centre, corner, 3-way, 4-way
- Aluminum tubing with full length channels for 6 mm thick glass
- Top cap and mounting base included
- Use Monolithic Toughened Glass

CAT. NO.	DESCRIPTION	1	12
D990A24E	Satin Anodised - End Part	£34.70	£31.84
D990BL24E	Matte Black - End Part	£39.51	£34.58
D990A24C	Satin Anodised - Centre Part	£40.57	£37.22
D990BL24C	Matte Black - Centre Part	£48.91	£42.80
D990A24CR	Satin Anodised - Corner Part	£40.57	£37.22
D990BL24CR	Matte Black - Corner Part	£48.91	£42.80
D990A243W	Satin Anodised - 3 Way Part	£46.28	£42.41
D990BL243W	Matte Black - 3 Way Part	£48.56	£42.49
D990BL244W	Matte Black - 4 Way Part	£56.54	£49.47

ALUMINIUM PARTITION POSTS - 30"

- 5 standard configurations – end, centre, corner, 3-way, 4-way
- Aluminum tubing with full length channels for 6 mm thick glass
- Top cap and mounting base included
- Use Monolithic Toughened Glass

CAT. NO.	DESCRIPTION	1	12
D990A30E	Satin Anodised - End Part	£38.95	£35.66
D990BL30E	Matte Black - End Part	£48.88	£42.77
D990A30C	Satin Anodised - Centre Part	£45.76	£41.98
D990BL30C	Matte Black - Centre Part	£58.77	£51.43
D990A30CR	Satin Anodised - Corner Part	£45.76	£41.98
D990BL30CR	Matte Black - Corner Part	£58.77	£51.43
D990A303W	Satin Anodised - 3 Way Part	£55.00	£50.00
D990BL303W	Matte Black - 3 Way Part	£48.88	£42.77
D990BL304W	Matte Black - 4 Way Part	£48.88	£42.77



CRL SCULPTURED SERIES ALUMINIUM PARTITION POSTS

CRL SCULPTURED SERIES ALUMINIUM PARTITION POSTS - 12"

- For use with 6 mm glazing
- Available in satin anodised, buffed brite anodised, duranodic bronze
- Use Monolithic Toughened Glass

CAT. NO.	DESCRIPTION	1	12
6406412	Satin Anodised - Centre Post	£12.53	£11.14
6409312	Matte Black - Centre Post	£14.58	£13.25
6406512	Satin Anodised - End Post	£12.11	£10.82
6409412	Matte Black - End Post	£14.59	£13.26
6406312	Satin Anodised - Corner Post	£12.38	£11.03
6409512	Matte Black - Corner Post	£14.23	£12.94

* Minimum order 1. Price based on an order quantity of 12 (6406512)

FROM ONLY

£10.82*

each

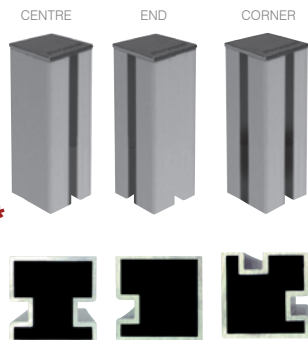

CRL SCULPTURED SERIES ALUMINIUM PARTITION POSTS - 18"

- For use with 6 mm glazing
- Available in satin anodised, buffed brite anodised, duranodic bronze
- Use Monolithic Toughened Glass

CAT. NO.	DESCRIPTION	1	12
6406418	Satin Anodised - Centre Post	£14.59	£12.46
6409418	Matte Black - Centre Post	£16.51	£15.01
6406518	Satin Anodised - End Post	£13.92	£11.92
6409518	Matte Black - End Post	£15.98	£14.53
6406318	Satin Anodised - Corner Post	£14.36	£12.21
6409318	Matte Black - Corner Post	£16.50	£15.00

* Minimum order quantity 1. Price based on an order quantity of 12 (6406518)

FROM ONLY

£11.92*

each

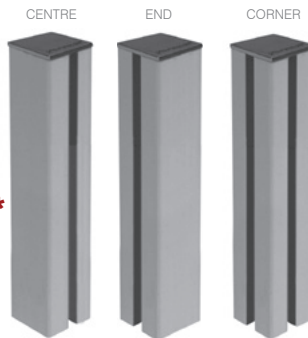

CRL SCULPTURED SERIES ALUMINIUM PARTITION POSTS - 24"

- For use with 6 mm glazing
- Available in satin anodised, buffed brite anodised, duranodic bronze
- Use Monolithic Toughened Glass

CAT. NO.	DESCRIPTION	1	12
6406424	Satin Anodised - Centre Post	£16.34	£13.84
6409424	Matte Black - Centre Post	£18.70	£17.00
6406524	Satin Anodised - End Post	£15.44	£13.15
6409524	Matte Black - End Post	£17.96	£16.33
6406324	Satin Anodised - Corner Post	£16.03	£13.54
6409324	Matte Black - Corner Post	£18.65	£16.95

* Minimum order quantity 1 Price based on an order quantity of 12 (6406524)

FROM ONLY

£13.15*

each





DESKTOP DESIGN SYSTEM

- A new and innovative range of desktop and countertop designs from CRL
- Using a modular system the installer can create glass screens of varying heights for either fixed or freestanding solutions
- A base profile with corner connectors provides one useful solution or the same profile can be used as post supports to be fixed back to the surface or to free standing feet

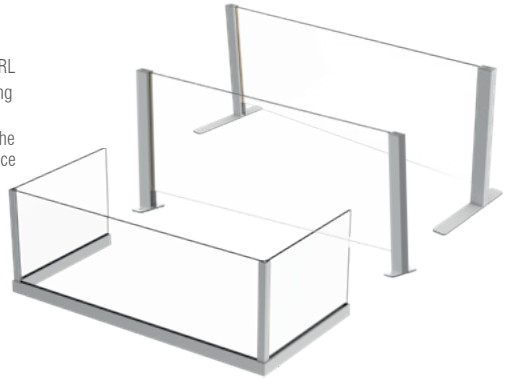

FROM ONLY

£17.30*

each

CAT. NO.	DESCRIPTION	1	6	12
DDSPROF1LESA	Satin Anodised - DDS profile, 3 m	£32.54	£29.83	£27.54
DDSLSA	Satin Anodised - DDS 90 deg. profile, 3 m	£20.45	£18.75	£17.30
DDSFSA	Satin Anodised - DDS base fixed flange, with top cap	£32.50	£29.79	£27.50
DDSFBSA	Satin Anodised - DDS free standing base plate, with top cap	£48.75	£44.68	£41.24
DDS2G	DDS 2 mm thickness gasket, 3 m	£1.95	£1.79	£1.65
DDS4G	DDS 4 mm thickness gasket, 3 m	£2.56	£2.34	£2.16
DDS6G	DDS 6 mm thickness gasket, 3 m	£3.50	£3.21	£2.96
DDSI CB	DDS Internal corner bracket	£4.28	£3.92	£3.62
DDSEC	DDS End caps (set of 2)	£8.60	£7.89	£7.28
DDSPS6	DDS Plastic support, for 6 mm glass	£0.77	£0.71	£0.65
DDSPS8	DDS Plastic support, for 9 mm glass	£0.77	£0.71	£0.65

* Minimum order 1. Price based on an order quantity of 12 (DDSLSA)

CRL WOOD'S POWR-GRIP® VACUUM CUP

- 203 mm diameter pad
- Check valve allows re-pumping without loss of remaining vacuum
- Release valve lever permits quick and complete release
- Fast attachment on smooth, non-porous flat surfaces
- Red-line indicator warns user of any vacuum loss
- Supplied with protective carrying case
- 57 kg lifting capacity

WAS £34.25

NOW FROM ONLY

£30.83*
each



N4950

N4000



CAT. NO.	DESCRIPTION	1	5	10
N4000	ABS Handle Vacuum Cup	£36.99	£33.62	£30.83
N4950	Metal Handle Vacuum Cup	£57.25	-	-

*Minimum order: 1 each. Price based on an order quantity of 10 (N4000).

CRL ALUMINIUM FRAME VACUUM LIFTERS

- Sturdily built traditional design plastic and aluminium frame
- Each suction pad operates separately
- 114 mm diameter suction pads

WAS £33.36

NOW FROM ONLY

£29.25*

each

CAT. NO.	DESCRIPTION	1	4
05062	2 Vacuum Pads - Aluminium	£34.20	£31.10
05062P	2 Vacuum Pads - Plastic	£32.15	£29.25
05063	3 Vacuum Pads - Aluminium	£39.85	£35.85
05063P	3 Vacuum Pads - Plastic	£44.70	£37.80

*Minimum order: 1. Price based on an order quantity of 4 (05062P).



05062

05063

05062P

05063P

CRL ALL TERRAIN DOLLY

- Exclusive to CRL
- Terrific for moving heavy glass panels around the job site
- Goes where other glass dollies won't
- Frame in solid aluminium
- Built-In 203 mm Wood's Powr-Grip® Vacuum Cup
- Includes a set of our RB200 Roller Blocks
- 181 kg load capacity

WAS £534.08

NOW ONLY

£388.00*

each



Included

CAT. NO.	DESCRIPTION	1
ATD1	All Terrain Dolly	£388.00

*Minimum order: 1. Price based on an order quantity of 1.

CRL ROLLER BLOCKS

- Roller design lets you rotate heavy glass panels with ease
- Turn them over to use as resting blocks
- Rubber base ensures traction

WAS £51.14

NOW FROM ONLY

£44.10*

per pair



CAT. NO.	DESCRIPTION	1
RB200	Roller Blocks	£44.10

*Minimum order: 1. Price based on an order quantity of 1.

CRL GLASSTRAX GLASS DOLLY

- Self clamping action locks loads up to 50.8 mm thick
- One person can load and manoeuvre
- Safe glass transport with large 272 kg capacity

FROM ONLY

£486.76*

each



CAT. NO.	DESCRIPTION	1
GT02	Glass Dolly	£486.76

*Minimum order: 1.

CRL CORNER PROTECTORS

- Designed to protect glass and mirror edges during shipping, handling or storing
- Will not scratch or damage glass or mirror surfaces, and help protect large cut-offs from breakage or becoming scrap
- Protectors are reusable, they simply slide on and off
- 1,000 per box



PRICE PER BOX OF 1000

CAT. NO.	GLASS THICKNESS	1	10
1463004K	4 mm	£56.50	£50.75
1463006K	6 mm	£51.10	£46.10
1463008K	8 mm	£46.10	£41.50
1463010K	10 mm	£52.80	£47.50
1463012K	12 mm	£53.90	£48.50

*Minimum order: 1 box. Price based on an order quantity of 10 boxes (1463008K).

NOW FROM ONLY

£41.50*
per box

CRL BLUE TRANSPORT PADS

- Medium density
- Low-tack, pressure sensitive adhesive
- Leaves no adhesive residue or ghosting marks

~~WAS £51.79~~

NOW FROM ONLY

£43.00*

each

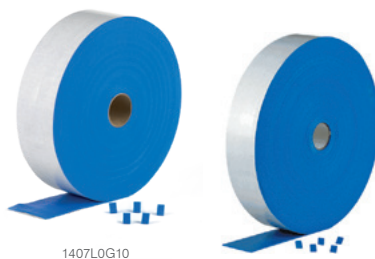

1407LOG10

1407LOG20

CAT. NO.	SIZE	QUANTITY	1	5
1407LOG10	24 x 19 x 4 mm	10,000 pads per roll	£47.00	£43.00
1407LOG20	21 x 18 x 4 mm	20,000 pads per roll	£79.00	£73.00

*Minimum order quantity: 1 roll. Price based on an order quantity of 5 rolls (1407LOG10)

CRL WOOD'S POWR-GRIP® VACUUM LIFTING FRAMES

- Cord-free operation with on-board gel cell battery
- 280 mm diameter lipped pads
- Locks in place every quarter turn
- Three configurations all from the same unit
- Load movement: manual rotation 360° edgewise with automatic locking at each 1/4 revolution, assisted manual tilt 90° between upright and flat
- Dual vacuum system
- 12V DC
- 320 kg lifting capacity

See more details at crlaurence.co.uk



EUMRTA811LDC3



EUMRTA811LDC3



EUMRT411LDC2

~~WAS £4134.43~~

NOW ONLY

£3,700.00*

each

CAT. NO.	DESCRIPTION	LIFTING CAPACITY	1
EUMRT411LDC2	D.C. Manual Rotator/Tilter - 4 pads	320 kg	£3,700.00
EUMRTA811LDC3	High-Flow D.C. Quadra Tilt Rotator - 8 pads	635 kg	£5,400.00

* Minimum order: 1 each. Price based on an order quantity of 1 (EUMRT411LDC2).

Wood's
Power-Grip



CRL WOOD'S POWR-GRIP® SINGLE CHANNEL D.C. VACUUM LIFTING FRAME

- Four 280 mm diameter lipped pads
- 180° edgewise rotation
- 90° tilt, vertical to flat
- Automatic 'self-test' function ensures that the cups are safely loaded
- High holding strength and safe to use due to the dual-circuit suction system
- 12V DC
- 320 kg lifting capacity

See more details at crlaurence.co.uk



~~WAS £3180.39~~

NOW FROM ONLY

£2,800.00*

each



CAT. NO.	DESCRIPTION	1
EUP11104DC0	Single Channel D.C. Vacuum Lifting Frame	£2,800.00

*Minimum order: 1 each. Price based on an order quantity of 1.

Wood's
Power-Grip



CRL ATLAS® CUT-RESISTANT KEVLAR® GLOVES

- Ergonomic fit as well as an outstanding grip
- The perfect glove for glass fabricators
- ANSI cut resistance: 3

~~WAS £9.94~~

NOW FROM ONLY

£7.66*

per pair



CAT. NO.	SIZE	1
300KVM	Medium	£7.66
300KVL	Large	£7.66
300KVXL	Extra Large	£7.66

*Minimum order: 1 pair. Price based on an order quantity of 1 pair (300KVM).

CRL CUT-RESISTANT POWERFLEX+ KEVLAR® GLOVES

- Excellent cut resistance and grip
- Protects against cuts, punctures, and slashes
- Cut Level 5
- Tested EN388 3444
- Sold by the pair

NOW FROM ONLY

£11.63*

per pair



CAT. NO.	SIZE	1	20
0626	Medium	£12.43	£11.63
0627	Large	£12.43	£11.63

* Minimum order: 1 pair. Price based on an order quantity of 20 pairs (0626).

CRL CUT RESISTANT LEVEL 5 WRIST GUARDS

- Our best value wrist guard
- Can be worn on either arm
- Loop and hook fastening
- Durable and comfortable
- BS EN 388 X-5-X-3
- Sold by the pair

~~WAS £13.17~~

NOW FROM ONLY

£11.80*

per pair



CAT. NO.	LENGTH	1	12	24
0601	152 mm	£13.50	£12.50	£11.80
06012	203 mm	£15.10	£13.90	£13.20

* Minimum order: 1 pair. Price based on an order quantity of 24 pairs (0601).

CRL TOYO® NOTCH WHEEL SUPERCUTTER®

- Achieve an ideal score with less pressure
- Excellent glass edge quality
- Longer wheel life
- Starting a score, notches "grip" the glass to eliminate slip
- Ideal for scoring large format glass
- Plastic handles
- Self-oiling cutter



~~WAS £15.37~~

NOW FROM ONLY

£13.30*
each

CAT. NO.	DESCRIPTION	1	6	12
TC70P	Patterned Head	£15.80	£14.20	£13.30
TC70HP	Replacement Cutting Head for TC70P	£10.90	£9.80	£9.10

*Minimum order: 1 each. Price based on an order quantity of 12 (TC70P).

CRL TOYO® ORIGINAL SUPERCUTTER®

- Brass or plastic straight end handles
- 140 degree hone angle carbide wheels
- For cutting 4 to 8 mm glass



~~WAS £15.75~~

NOW FROM ONLY

£12.40*
each

CAT. NO.	DESCRIPTION	1	6	12
TC17B	Brass Handle	£14.70	£13.90	£12.40
TC17P	Plastic Handle	£16.10	£14.05	£12.75
TC17H	Replacement Cutting Head - Wide	£10.30	£9.70	£8.90

*Minimum order: 1 each. Price based on an order quantity of 12 (TC17B).

CRL SINGLE EDGE RAZOR BLADES

- Our most popular single edge blade
- Precision honed, surgical steel edges
- Individually wrapped to protect the edge
- Multiple uses
- 100 per box

~~WAS £3.28~~

NOW FROM ONLY

£2.79*



PRICE PER BOX OF 100 BLADES

CAT. NO.	DESCRIPTION	1	2	5	50	100
51S	Single Edge Razor Blades	£3.53	£3.36	£3.14	£2.96	£2.79

*Minimum order: 1 box. Price based on an order quantity of 100 boxes.

BEST SELLER

CRL RAZOR BLADE HOLDER AND SCRAPER

- Safely holds single edge metal razor blades
- Comfortable handle for a sure grip
- Compatible with 51S and KKB12 razor blades

~~WAS £6.65~~

NOW ONLY

£5.20*
each



CAT. NO.	DESCRIPTION	1
RS65	Razor Blade Holder and Scraper	£5.20

*Minimum order: 1 each. Price based on an order quantity of 1.

CRL SEALANT FINISHING TOOL

- Lightweight and flexible, simplifies tooling of sealants
- Titanium catalyst material will not stick to silicone or other sealants
- 83 mm x 89 mm x 5 mm

WAS ~~£2.76~~

NOW FROM ONLY

£1.75*
each



55BSS

CAT. NO.	DESCRIPTION	1	6
55BSS	Sealant Finishing Tool	£2.65	£1.75

*Minimum order: 1. Price based on an order quantity of 6.

CRL PLASTIC STICK TOOL

- A very popular tool with limitless uses
- Perfect for tooling freshly applied sealants, pushing vinyl into window channels, mixing paint and setting or removing glass from rubber gaskets
- Made of special high strength, flexible plastic
- CRL216 tapered on both ends
- CRL220 tapered and chisel end on one tool
- Stick handle available, CRL216H

FROM ONLY

£0.47*
each

CRL216



CRL220



MULTI-USAGE

CAT. NO.	DESCRIPTION	1	10	50	100
CRL216	Tapered End	£0.76	£0.64	£0.55	£0.51
CRL220	Chisel End	£0.66	£0.58	£0.51	£0.47

*Minimum order: 1 each. Price based on an order quantity of 100 (CRL220).

CRL FACE CAP REMOVER

- For lifting and setting plate glass
- Helps prevent lifting related injuries
- Aids in storefront window installation
- Width: 273 mm

WAS ~~£29.14~~

NOW FROM ONLY

£19.20*
each



Tailor made for curtain wall installers!

CAT. NO.	DESCRIPTION	1	5	10
FCR1	Face Cap Remover	£25.60	£21.90	£19.20

*Minimum order: 1 each. Price based on an order quantity of 10.

CRL NOZZLE CUTTER

- Use on all plastic cartridges to cut nozzle tip and threaded tip then cut the nozzle tip to the desired opening size at the proper angle

WAS ~~£15.23~~

NOW FROM ONLY

£13.40*
each



CAT. NO.	DESCRIPTION	1	6
NC594	Nozzle Cutter	£14.60	£13.40

*Minimum order: 1. Price based on an order quantity of 6.



CRL NEUTRAL CURE CONSTRUCTION SILICONE

- Neutral cure, low modulus silicone
- Versatile sealant
- Cures under the influence of humidity to form a durable elastic rubber seal
- Specifically developed for durable elastic sealing of expansion joints in concrete, brickwork, curtain wall constructions, kitchens, bathrooms, showers, industrial applications and glazing systems
- UV, water, weather and mould resistant
- Available in clear, black and white
- 300 ml cartridge
- 12 per case

WAS £1.91

NOW FROM ONLY

£1.79*
each

CAT. NO.	COLOUR	1	12	120	240
CRLNCSC	Clear	£2.25	£2.08	£1.93	£1.79
CRLNCSDL	Black	£2.25	£2.08	£1.93	£1.79
CRLNCSSW	White	£2.25	£2.08	£1.93	£1.79

*Minimum order: 1 cartridge. Price based on an order quantity of 240 cartridges (CRLNCSC).



CRL MS POLYMER MIRROR FIX

- High quality professional mirror and painted glass adhesive developed with MS Polymer hybrid technology
- Adheres without the use of primer to most non-porous substrates
- Free of isocyanates, solvents, silicones and plasticiser
- No shrinkage
- UV, water, weather and mould resistant
- Mirrors should be mechanically supported while the adhesive is curing
- Colour: White
- 290 ml cartridge
- 12 per case



WAS £1.98

NOW FROM ONLY

£1.85*

each

CAT. NO.	COLOUR	1	12	60	120
EGMSF1X	White	£2.32	£2.14	£1.98	£1.85

*Minimum order: 1 cartridge. Price based on an order quantity of 120 cartridges.

CRL EG310ULTRA COMPLETE ADHESIVE

- MS Polymer based
- Neutral curing and odourless
- Cures with atmospheric moisture
- Super-fast bonding of mirrors, glass, wood, composite panels and metal to a range of substrates
- Free of silicone and isocyanides
- 290 ml cartridge
- 12 per case



WAS £5.09

NOW FROM ONLY

£3.90*

each

CAT. NO.	DESCRIPTION	PRICE PER CARTRIDGE			
		1	60	120	240
EG310ULTRA	Complete Adhesive	£5.10	£4.60	£4.15	£3.90

*Minimum order: 1 cartridge. Price based on an order quantity of 240 cartridges.

CRL EG310 EVERGRIP™ MIRROR ADHESIVE

- Extra fast grab mirror adhesive
- Extra strong holding capacity
- Fast curing, with skin formation in about five minutes
- Adhesion to almost all surfaces
- Low VOC, solvent free, low odour
- 310 ml cartridge



WAS £3.00

NOW FROM ONLY

£2.27*

each

CAT. NO.	DESCRIPTION	PRICE PER CARTRIDGE			
		12	60	120	240
EG310	Mirror Adhesive	£3.25	£2.95	£2.57	£2.27

*Minimum order: 12 cartridges. Price based on an order quantity of 240 cartridges.

CRL STANDARD SMOOTH ROD CAULKING GUN

- Our best seller is also great value
- Thumb pressure release button
- Perfect for low viscosity materials

~~WAS £3.96~~

FROM ONLY

£2.55*
each

BEST SELLER



CAT. NO.	DESCRIPTION	1	12
ER3	Standard Smooth Rod Caulking Gun	£2.75	£2.55

*Minimum order: 1 each. Price based on an order quantity of 12.

CRL 12:1 RATIO STRAP FRAME CAULKING GUN

- Holds standard caulking cartridges
- Best choice for low to medium viscosity materials
- Instant pressure release to prevent run-on

~~WAS £15.96~~

FROM ONLY

£10.20*
each



CAT. NO.	DESCRIPTION	1	12
GA1203	12:1 Ratio Strap Frame Caulking Gun	£12.60	£10.20

*Minimum order: 1 each. Price based on an order quantity of 12.

CRL BLUE SURFACE PROTECTION FILM

- 40 micron blue film
- Adhesive free
- No residue
- Static hold
- Prevents scratches
- 1,000 m length

~~WAS £95.88~~

FROM ONLY

£84.10*
each



CAT. NO.	WIDTH	1	10
21S600B	600 mm	£91.60	£84.10
21S1200B	1,200 mm	£183.20	£168.20
21S1800B	1,800 mm	£268.30	£246.10

*Minimum order: 1 roll. Price based on an order quantity of 10 rolls (21S600B).

CRL MIRABAC POLYPROPYLENE MIRROR BACKING

- Keeps glass fragments together should mirror accidentally break, reducing the chance of personal injury
- Ready to use and easy-to-apply
- Tested to BS EN 12600
- 60 Micron
- 290 ml cartridge
- 12 per case

~~WAS £14.70~~

FROM ONLY

£12.65*
each



CAT. NO.	ROLL SIZE	1	10	20
21051	300 mm x 100 m	£17.10	£14.40	£12.65
21052	450 mm x 100 m	£25.11	£21.40	£18.75
21053	604 mm x 100 m	£34.10	£31.30	£25.35
21054	604 mm x 250 m	£92.10	£82.50	£66.95

*Minimum order: 1 Roll. Price based on an order quantity of 20 rolls (21051).



CRL ED SERIES MIRROR MOUNTING SET

Press button mirror mounting set includes eccentric discs, press buttons, self adhesive pads, screws and wall plugs.

~~WAS £3.29~~

NOW FROM ONLY

£2.66*
each

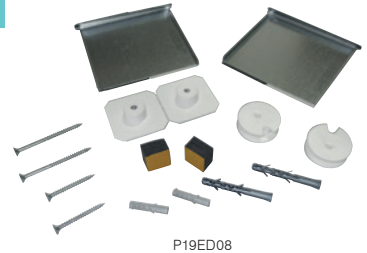

CAT. NO.	SIZE	1	24	48
P19ED08	For mirrors up to 0.8 m ²	£3.11	£2.88	£2.66
P19ED16	For mirrors up to 1.6 m ²	£4.24	£3.88	£3.59
P19ED26	For mirrors up to 2.6 m ²	£5.77	£5.29	£4.88

*Minimum order: 1 set. Price based on an order quantity of 48 (P19ED08)

CRL EM SERIES MIRROR MOUNTING SET

Magnetic mirror mounting set includes, eccentric discs, mirror adhesive, magnets, mirror plates, self adhesive pads and wall plugs.

~~WAS £4.49~~

NOW FROM ONLY

£3.82*
each

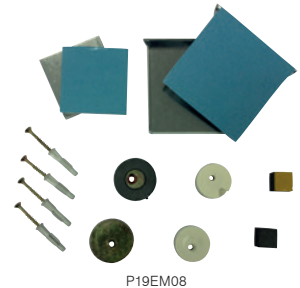

CAT. NO.	SIZE	1	24	48
P19EM08	For mirrors up to 0.8 m ²	£4.39	£4.08	£3.82
P19EM16	For mirrors up to 1.6 m ²	£5.39	£4.94	£4.56
P19EM26	For mirrors up to 2.6 m ²	£6.46	£5.96	£5.54

*Minimum order: 1 set. Price based on an order quantity of 48 (P19EM08)

CRL LD SERIES MIRROR MOUNTING SET

Simple mirror mounting bracket set includes press buttons, mounting brackets, mirror plates self adhesive pads, screws, washers and wall plugs.

~~WAS £3.34~~

NOW FROM ONLY

£2.81*
each

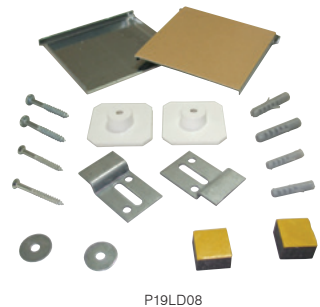

CAT. NO.	SIZE	1	24	48
P19LD08	For mirrors up to 0.8 m ²	£3.32	£3.04	£2.81
P19LD16	For mirrors up to 1.6 m ²	£4.29	£3.94	£3.63
P19LD26	For mirrors up to 2.6 m ²	£6.24	£5.72	£5.28

*Minimum order: 1 set. Price based on an order quantity of 48 (P19LD08)

CRL DEEP NOSE ALUMINIUM J-BAR FOR MIRROR

- Punched and slotted for easier installation
- 3.66 m stock lengths
- 40 per case

WAS £10.56

NOW FROM ONLY

£6.92*
each

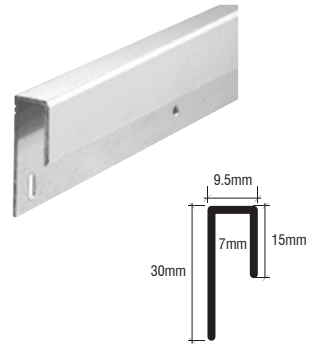

CAT. NO.	FINISH	1	10	40	80	120
D645BA	Bright Anodised	£12.74	£9.86	£8.73	£8.28	£8.04
D645BN	Brushed Nickel	£13.71	£10.61	£9.41	£8.65	£7.83
D645A	Satin Anodised	£12.11	£9.38	£8.31	£7.65	£6.92

*Minimum order: 1 length. Price based on an order quantity of 120 (D645A).

CRL STANDARD ALUMINIUM J-BAR FOR MIRROR

- Punched and slotted for easier installation
- 3.66 m stock lengths
- 50 per case

WAS £9.59

NOW FROM ONLY

£5.97*
each

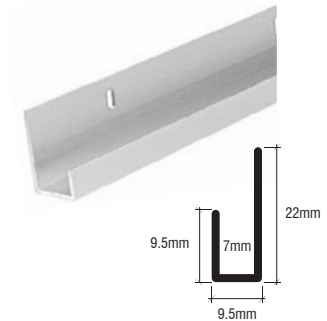

CAT. NO.	FINISH	1	10	40	80	120
D636BA	Bright Anodised	£11.95	£9.56	£7.97	£6.82	£5.97
D636BN	Brushed Nickel	£13.91	£11.02	£9.11	£8.02	£7.14
D636A	Satin Anodised	£10.37	£8.77	£7.61	£6.71	£6.01

*Minimum order: 1 length. Price based on an order quantity of 120 (D636BA).

CRL DEEP NOSE ALUMINIUM FACE L-BAR EXTRUSION

- 3.66 m stock lengths
- 50 per case

WAS £8.73

NOW FROM ONLY

£5.67*
each

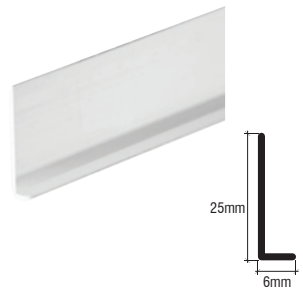

CAT. NO.	FINISH	1	10	50	100	150
L902BA	Bright Anodised	£22.54	£18.31	£15.42	£13.32	£11.72
L902BN	Brushed Nickel	£26.64	£20.93	£14.65	£12.21	£10.47
L902A	Satin Anodised	£10.27	£8.31	£7.19	£6.34	£5.67

*Minimum order: 1 length. Price based on an order quantity of 50 (L902A).

CRL STANDARD ALUMINIUM FACE L-BAR EXTRUSION

- 3.66 m stock lengths
- 50 per case

WAS £8.49

NOW FROM ONLY

£4.81*
each

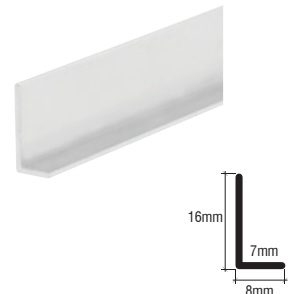

CAT. NO.	FINISH	1	10	50	100	150
L502BA	Bright Anodised	£11.78	£9.81	£8.41	£7.36	£6.32
L502BN	Brushed Nickel	£25.24	£16.06	£11.78	£9.31	£7.68
L502A	Satin Anodised	£8.66	£7.21	£6.18	£5.41	£4.81

*Minimum order: 1 length. Price based on an order quantity of 150 (L502A).

CRL GLASS AND MIRROR CLEANER

- A long time favourite of the glass industry
- Ammoniated formula with a pleasant aroma
- Available in 660 ml can or in 1 litre spray bottle

~~WAS £2.24~~

NOW FROM ONLY

£1.55*



**OWN LABEL
VERSIONS AVAILABLE**
CALL FREEPHONE 00 800 0421 6144
FOR MORE DETAILS



EB1701



EB1701T

CAT. NO.	CONTENTS	12	60	144
EB1701	660 ml can	£1.84	£1.68	£1.55
EB1701T	1 litre spray bottle	£2.04	£1.95	£1.79

*Minimum order: 12 each. Must be ordered in increments of 12 each. Price based on an order quantity of 144 (EB1701).



CRL EASI-CLEAN PRE-CLEAN SHOWER PROTECTOR

- Stage one - Pre-clean
- Non-irritant
- UV stable for long life
- Abrasion resistant
- Hydrophobic protection
- Permanent bond
- Recommended for use with Pre-Clean Cloth (red)

~~WAS £4.68~~

NOW FROM ONLY

£4.10*
each

STAGE ONE PRE-CLEAN

CAT. NO.	CONTENT	1	6
ECPC010	100 ml	£4.47	£4.10
ECPC025	250 ml	£8.25	£7.56
ECPC050	500 ml	£11.51	£10.55
ECPC100	1 Litre	£17.31	£15.86

*Minimum order: 1. Price based on an order quantity of 6 (ECPC010).

CAT. NO.	CONTENT	1	10	50
ECPCCLOTH	Red cloth - Pre Clean	£1.41	£1.27	£1.17



CRL EASI-CLEAN PROTECT SHOWER PROTECTOR

- Stage two - Protect
- Non-irritant
- UV stable for long life
- Abrasion resistant
- Hydrophobic protection
- Permanent bond
- Recommended for use with Protect Cloth (blue)

WAS £11.40

NOW FROM ONLY

£9.83*

each

STAGE TWO PROTECT



CAT. NO.	CONTENT	1	6
ECP010	100 ml	£10.72	£9.83
ECP025	250 ml	£23.89	£21.90
ECP050	500 ml	£42.80	£39.20
ECP100	1 Litre	£79.85	£73.25

*Minimum order: 1. Price based on an order quantity of 6 (ECP010).

CAT. NO.	CONTENT	1	10	50
ECPCLOTH	Blue Cloth - Protect	£1.41	£1.27	£1.17

CRL EASI-CLEAN AFTERCARE GLASS CLEANER

- Non-silicone based glass cleaner
- Leaves glass clear and smear free
- Ideal for shower screens

WAS £4.49

NOW FROM ONLY

£3.96*

each



CAT. NO.	CONTENT	1	10
ECAC6050	500 ml	£4.32	£3.96

*Minimum order: 1.

CRL WALL MOUNT BRACKETS

- Component to provide fixed panel support for enclosures not going to the ceiling
- Compatible with CRL support bars
- Chrome finish

~~WAS £5.00~~

NOW FROM ONLY

£4.32*

each

CAT. NO.	DESCRIPTION	1	6
SQ46CH	Square Wall Mount Bracket	£7.67	£6.94
SQJ46CH	Square Slimline Wall Mount Bracket	£5.37	£4.83
S12CH	Round Wall Mount Bracket	£4.77	£4.32

*Minimum order: 1. Price based on an order quantity of 6 (S12CH).



CRL BRACKETS

- For use with 6 to 8 mm glass
- Component to provide fixed panel support for enclosures not going to the ceiling
- No hole required in the glass
- Chrome finish

~~WAS £8.52~~

NOW FROM ONLY

£7.45*

each

CAT. NO.	DESCRIPTION	1	6
SQ41CH	Swivelling U-Bracket	£12.54	£11.66
SQJ41CH	Swivelling Slimline U-Bracket	£7.94	£7.45
S4VCH	Round Swivelling Stabiliser	£11.21	£10.18

*Minimum order: 1. Price based on an order quantity of 6 (SQJ41CH).

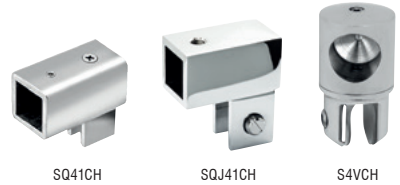

CRL SUPPORT BARS

- Component to provide fixed panel support for enclosures not going to the ceiling
- Compatible with a large range of CRL brackets to meet your needs
- Chrome finish

~~WAS £16.37~~

NOW FROM ONLY

£14.69*

each

CAT. NO.	DESCRIPTION	SIZE	1	6
S1CH	1 m Round Support Bar	19 mm	£15.86	£14.69
S2CH	1,295 mm Round Support Bar	19 mm	£20.59	£18.63
SQ39CH	1 m Square Support Bar	19 mm	£27.13	£25.24
SQJ39CH	1 m Square Slimline Support Bar	15 mm	£27.83	£25.84

*Minimum order: 1. Price based on an order quantity of 6 (S1CH).

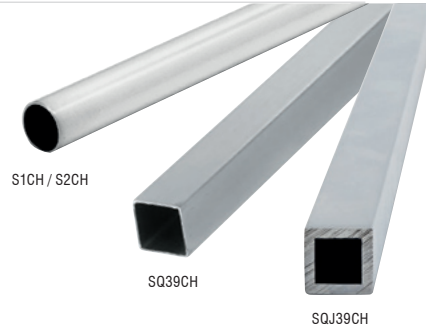

CRL ALUMINIUM U-CHANNEL FOR 6 TO 8MM GLASS

- Available in 2.49 m lengths
- Wet glaze with clear silicone
- Extremely versatile extrusion in up to 5 popular finishes - see crlaurence.co.uk

~~WAS 9.16~~

NOW FROM ONLY

£8.24*

each

CAT. NO.	FINISH	1	10	40	80	120
SDCD516BA	Bright Anodised	£10.99	£9.99	£9.16	£8.46	£8.24
SDCD516BN	Brushed Nickel	£10.85	£9.94	£9.18	£8.95	£8.53
SDCD516MBL	Matte Black	£24.86	£20.71	£17.75	£15.54	£13.82

*Minimum order: 1 each. Price based on an order quantity of 120 (CAT. NO. SDCD516BA).

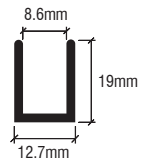
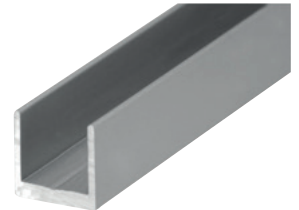

CRL ALUMINIUM U-CHANNEL FOR 10MM GLASS

- Wet glazed with clear silicone to secure glass
- Available in 2.49 m and 3.65 m stock lengths
- Available in up to 17 finishes - see crlaurence.co.uk

WAS ~~£9.80~~

NOW FROM ONLY

£8.82*
each

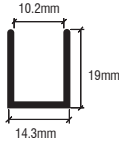
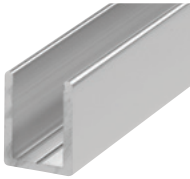

SDCD38

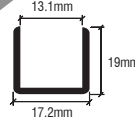
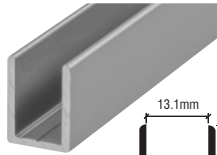

SDCD12

CAT. NO.	FINISH	LENGTH	DEPTH	1	10	40	80	120
SDCD38BA	Bright Anodised	2.49 m	19 mm	£11.32	£10.66	£9.59	£9.11	£8.82
SDCD38BN	Brushed Nickel	2.49 m	19 mm	£12.15	£9.59	£9.11	£8.87	£8.63
SDCD38MBL	Matte Black	2.49 m	19 mm	£23.77	£21.12	£19.01	£17.28	£15.84
SDCD3812BA	Bright Anodised	3.65 m	19 mm	£19.82	£17.84	£16.19	£14.90	£13.70
SDCD3812BN	Brushed Nickel	3.65 m	9.5 mm	£20.54	£18.22	£16.78	£15.38	£14.12
SDCD3812MBL	Matte Black	3.65 m	9.5 mm	£34.82	£29.01	£26.11	£23.74	£20.89
SDCD12BA	Bright Anodised	2.49 m	19 mm	£12.29	£10.81	£9.91	£9.39	£8.91
SDCD12BN	Brushed Nickel	2.49 m	19 mm	£12.91	£11.73	£10.75	£9.93	£9.21
SDCD12MBL	Matte Black	2.49 m	19 mm	£24.86	£20.94	£18.07	£15.91	£14.21

*Minimum order: 1 each. Price based on an order quantity of 120 (CAT. NO. SDCD38BA).

CRL DRY GLAZE U-CHANNEL WITH VINYL FOR 8 AND 10MM GLASS

- Clear vinyls secure glass in channel and eliminate the need for messy silicone
- Recess in bottom channel hides caulk line
- DUC38 can be used with 8mm glass where RV8DUC rigid vinyl is used (available separately)
- Individually packaged
- 2.49 m length

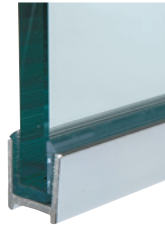

WAS ~~£18.60~~

NOW FROM ONLY

£14.07*
each

NOTE: glass is not included

CAT. NO.	FINISH	1	10	50
DUC516BA	Bright Anodised	£19.83	£17.01	£14.07
DUC516BN	Brushed Nickel	£22.05	£19.92	£18.19
DUC38BA	Bright Anodised	£18.02	£17.03	£16.11
DUC38BN	Brushed Nickel	£20.51	£19.66	£18.17

*Minimum order: 1 each. Price based on an order quantity of 50 (DUC516BA).

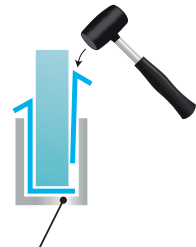
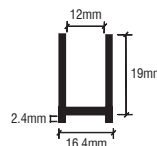

Complete by securing U-Channel

CRL CLEAR 'Y' JAMB SEAL WITH SOFT LEG

- Soft vinyl single leg for quieter door closure
- Snaps onto fixed panel
- For 180° inline glass-to-glass applications
- Suggested gap: 4.7 mm
- 2.49 m stock length

WAS £9.69

NOW FROM ONLY

£6.20*

each

CAT. NO.	GLASS THICKNESS	1	10	40
PCC10	10 mm	£7.88	£6.92	£6.20

*Minimum order: 1 each. Price based on an order quantity of 40.

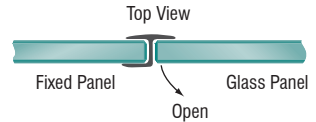
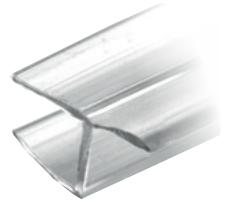
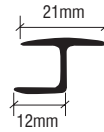

CRL CLEAR VINYL BULB SEAL

- Can be used on inswing and outswing doors
- Suggested gap: 6 to 8 mm
- 2.49 m stock length

WAS £6.42

NOW FROM ONLY

£6.15*

each

CAT. NO.	GLASS THICKNESS	1	10	40
PCR10	10 mm	£7.20	£6.50	£6.15

*Minimum order: 1 each. Price based on an order quantity of 40.



CRL CLEAR CO-EXTRUDED BOTTOM WIPE WITH DRIP RAIL

- Snaps on bottom of door
- 45° drip rail assists in deflecting water back into the enclosure
- Suggested gap: 11 mm
- 2.49 m stock length

WAS £5.50

NOW FROM ONLY

£5.14*

each

CAT. NO.	GLASS THICKNESS	1	10	40
P990WS	10 mm	£6.18	£5.60	£5.14

*Minimum order: 1 each. Price based on an order quantity of 40.

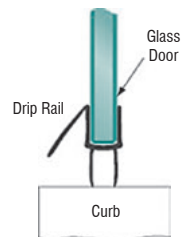
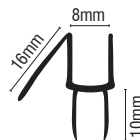

CRL GENEVA SERIES SHOWER HINGES

- For 8 to 12 mm toughened safety glass
- Our most popular hinge series
- Square corner hinge design
- Self-centering when within 15° of closed position
- Construction: solid brass



GEN037

GEN044

GEN180

CAT. NO.	DESCRIPTION	FINISH	1	16
GEN037CH	Wall Mount Full Back Plate Hinge	Chrome	£23.70	£22.32
GEN037BN	Wall Mount Full Back Plate Hinge	Brushed Nickel	£23.70	£22.32
GEN037MBL	Wall Mount Full Back Plate Hinge	Matte Black	£33.52	£30.12
GEN044CH	Wall Mount Offset Back Plate Hinge	Chrome	£24.06	£22.31
GEN044BN	Wall Mount Offset Back Plate Hinge	Brushed Nickel	£24.06	£22.31
GEN044MBL	Wall Mount Offset Back Plate Hinge	Matte Black	£32.65	£30.92
GEN180CH	180 Degree Glass-to-Glass Hinge	Chrome	£32.51	£30.85
GEN180BN	180 Degree Glass-to-Glass Hinge	Brushed Nickel	£32.51	£30.85
GEN180MBL	180 Degree Glass-to-Glass Hinge	Matte Black	£39.73	£37.01

*Minimum order: 1 each. Price based on an order quantity of 16 (GEN037CH).

Maximum Capacities	8 mm to 12 mm glass	
	Weight	Door Width
Using Two Hinges	36 kg	711 mm
Using Three Hinges	54 kg	813 mm

NOTE: Do not exceed maximum door weight or width when choosing proper quantity of hinges.

~~WAS £25.33~~

NOW FROM ONLY

£22.32*

each

CRL GENEVA CLAMPS

- For 8 to 12 mm toughened safety glass
- Clamps match configuration of our popular Geneva hinge plus many more
- Square corner clamp design
- Construction: solid brass

~~WAS £29.97~~

NOW FROM ONLY

£26.53*

each



GE90S

GE90B

CAT. NO.	DESCRIPTION	FINISH	1	10	50
GE90SCH	Wall Mount Geneva Glass Clamp	Chrome	£30.51	£28.38	£26.53
GE90SBN	Wall Mount Geneva Glass Clamp	Brushed Nickel	£31.98	£29.20	£27.99
GE90CH	90° Glass-to-Glass Geneva Clamp	Matte Black	£36.82	£33.40	£32.62
GE90BN	90° Glass-to-Glass Geneva Clamp	Brushed Nickel	£38.84	£36.11	£33.75

*Minimum order: 1 each. Price based on an order quantity of 50 (GE90SCH).

CRL PINNACLE SERIES SHOWER HINGES

- For 8 to 12 mm toughened safety glass
- Bevelled edge hinge design
- Self-centering when within 15° of closed position
- Construction: solid brass

~~WAS £27.74~~

NOW FROM ONLY

£24.99*
each

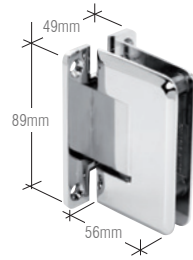

P1N037

CAT. NO.	DESCRIPTION	FINISH	1	16
P1N037CH	Wall Mount Full Back Plate Hinge	Chrome	£26.92	£24.99
P1N037BN	Wall Mount Full Back Plate Hinge	Brushed Nickel	£26.92	£24.99
P1N037MBL	Wall Mount Full Back Plate Hinge	Matte Black	£30.54	£28.31
P1N044CH	Wall Mount Offset Back Plate Hinge	Chrome	£26.92	£24.99
P1N044BN	Wall Mount Offset Back Plate Hinge	Brushed Nickel	£26.92	£24.99
P1N044MBL	Wall Mount Offset Back Plate Hinge	Matte Black	£36.22	£33.81
P1N180CH	180 Degree Glass-to-Glass Hinge	Chrome	£39.68	£36.71
P1N180BN	180 Degree Glass-to-Glass Hinge	Brushed Nickel	£39.68	£36.71
P1N180MBL	180 Degree Glass-to-Glass Hinge	Matte Black	£51.15	£47.32

*Minimum order: 1 each. Price based on an order quantity of 16 (P1N037CH).



P1N044



P1N180

Maximum Capacities	8 mm and 12 mm glass	
	Weight	Door Width
Using Two Hinges	36 kg	711 mm
Using Three Hinges	54 kg	813 mm

NOTE: Do not exceed maximum door weight or width when choosing proper quantity of hinges.

CRL PINNACLE CLAMPS

- For 8 to 12 m toughened safety glass
- Clamps match configuration of our popular Pinnacle hinge plus may more
- Bevelled corner clamp design
- Construction: solid brass

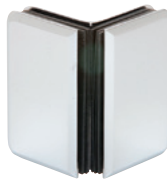

P1090



P190S

CAT. NO.	DESCRIPTION	FINISH	1	10	50
P190SCH	Wall Mount Pinnacle Glass Clamp	Chrome	£34.80	£32.35	£30.44
P190SBN	Wall Mount Pinnacle Glass Clamp	Brushed Nickel	£34.16	£31.26	£29.75
P1090CH	90° Glass-to-Glass Pinnacle Clamp	Chrome	£41.77	£37.53	£35.71
P1090BN	90° Glass-to-Glass Pinnacle Clamp	Brushed Nickel	£41.77	£37.53	£35.71

*Minimum order: 1 each. Price based on an order quantity of 50 (P190SBN).

~~WAS £32.86~~

NOW FROM ONLY

£29.75*
each

CRL ALTEA SERIES SHOWER HINGES

- For 6 to 10 mm toughened safety glass
- Cover plates hide fixing screws for a sleek, modern appearance
- Square corner hinge design
- Self closes from approximately 60°
- Construction: solid brass

~~WAS £18.21~~

NOW FROM ONLY

£17.77*
each



CAT. NO.	DESCRIPTION	FINISH	1	10	50
ALT037CH	Wall Mount Full Back Plate Hinge	Chrome	£21.32	£19.74	£17.77
ALT037MBL	Wall Mount Full Back Plate Hinge	Matte Black	£26.04	£23.43	£21.32
ALT180CH	180 Degree Glass-to-Glass Hinge	Chrome	£28.13	£23.53	£22.31
ALT180MBL	180 Degree Glass-to-Glass Hinge	Matte Black	£32.08	£27.43	£25.61

*Minimum order: 1 each. Price based on an order quantity of 16 (ALT037CH).

Maximum Capacities	6 mm to 10 mm glass	
	Weight	Door Width
Using Two Hinges	36 kg	710 mm
Using Three Hinges	54 kg	810 mm

NOTE: Do not exceed maximum door weight or width when choosing appropriate quantity of hinges.

CRL ALTEA CLAMPS

- For 6 to 10 mm toughened safety glass
- Clamps match configuration of Altea hinges
- Square corner clamp design
- Cover plates hides fixing screws for a sleek modern appearance
- Easy to install



CAT. NO.	DESCRIPTION	FINISH	1	10	50
ALTC90CH	90° Glass-to-Wall Clamp	Chrome	£12.77	£11.28	£10.57
ALTC90MBL	90° Glass-to-Wall Clamp	Brushed Nickel	£14.95	£13.91	£12.42
ALTC380CH	Adjustable Glass-to-Glass Clamp	Chrome	£17.01	£14.66	£13.72
ALTC380MBL	Adjustable Glass-to-Glass Clamp	Brushed Nickel	£20.48	£17.65	£16.52

*Minimum order: 1 each. Price based on an order quantity of 16 (ALTC90CH).

~~WAS £10.82~~

NOW FROM ONLY

£10.57*
each

CRL SHOWER DOOR KNOB

- For 6 to 12 mm toughened safety glass
- Attractive ribbed appearance
- 12 mm diameter hole required

~~WAS £12.21~~

NOW FROM ONLY

£10.96* each

CAT. NO.	DESCRIPTION	FINISH	1	10	50
SDK160CH	Back-to-Back Square Style Knob	Chrome	£16.68	£14.84	£13.36
SDK160BN	Back-to-Back Square Style Knob	Brushed Nickel	£16.68	£14.84	£13.36
SDK160MBL	Back-to-Back Square Style Knob	Matte Black	£19.62	£18.64	£16.57
SDK106CH	Back-to-Back Contemporary Style Knob	Chrome	£12.57	£11.87	£10.96
SDK106BN	Back-to-Back Contemporary Style Knob	Brushed Nickel	£13.99	£12.82	£11.84
SDK106MBL	Back-to-Back Contemporary Style Knob	Matte Black	£14.43	£14.07	£12.99

*Minimum order: 1 each. Price based on an order quantity of 50 (SDK106CH).



SDK160



SDK106

CRL BACK-TO-BACK PADDLE KNOB

- For 6 to 12 mm toughened safety glass
- Flat 'paddle' shape appearance with square corners
- Two 12 mm diameter holes required

~~WAS £31.49~~

NOW FROM ONLY

£27.72* each

CAT. NO.	DESCRIPTION	FINISH	1	10	50
SDK180CH	Back-to-Back Paddle Style	Chrome	£32.83	£29.71	£27.72
SDK180BN	Back-to-Back Paddle Style	Brushed Nickel	£41.61	£38.06	£33.75
SDK180MBL	Back-to-Back Paddle Style	Matte Black	£41.43	£36.38	£33.91

*Minimum order: 1 each. Price based on an order quantity of 50 (SDK180CH).



CRL LADDER STYLE BACK-TO-BACK PULL HANDLE

- For 8 to 12 mm toughened safety glass
- Mounting holes 152 and 203 mm centre-to-centre
- Two 12 mm diameter hole required

~~WAS £49.41~~

NOW FROM ONLY

£47.12* each

CAT. NO.	DESCRIPTION	FINISH	1	10	50
LP6X6CH	152 mm Handle	Chrome	£52.35	£49.61	£47.12
LP6X6BN	152 mm Handle	Brushed Nickel	£52.35	£49.61	£47.12
LP6X6MBL	152 mm Handle	Matte Black	£57.25	£52.53	£49.21
LP8X8CH	203 mm Handle	Chrome	£58.54	£54.81	£51.52
LP8X8BN	203 mm Handle	Brushed Nickel	£58.54	£54.81	£51.52
LP8X8MBL	203 mm Handle	Matte Black	£62.41	£57.70	£54.61

*Minimum order: 1 each. Price based on an order quantity of 50 (LP6X6CH).



LP6X6MBL

LP8X8MBL

CRL BM SERIES BACK-TO-BACK PULL HANDLE

- For 6 to 12 mm toughened safety glass
- Mounting holes 152 and 203 mm centre-to-centre
- With metals washers
- Two 12 mm diameter holes required

~~WAS £15.39~~

NOW FROM ONLY

£13.85* each

CAT. NO.	DESCRIPTION	FINISH	1	10	50
BM6X6CH	152 mm Handle	Chrome	£16.92	£15.24	£13.85
BM6X6BN	152 mm Handle	Brushed Nickel	£16.92	£15.24	£13.85
BM6X6MBL	152 mm Handle	Matte Black	£17.12	£15.63	£13.99
BM8X8CH	203 mm Handle	Chrome	£19.08	£17.08	£15.61
BM8X8BN	203 mm Handle	Brushed Nickel	£19.08	£17.08	£15.61
BM8X8MBL	203 mm Handle	Matte Black	£19.33	£17.54	£16.30

*Minimum order: 1 each. Price based on an order quantity of 50 (BM6X6CH).

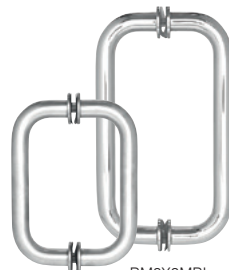

BM6X6MBL

BM8X8MBL

CRL HYDROSLIDE SERIES SLIDING SHOWER DOOR SYSTEM



- Excellent design for compact areas
- Quick and easy installation
- Clean, sleek lines
- Available in four stock finishes, custom finishes available
- Custom units available by special order
- Glass fabrication required
- For use with 8 mm to 10 mm monolithic toughened glass

Standard 180 Degree Kit Includes:

- 1 - Sliding glass door upper track
- 2 - Hangers for sliding glass door
- 2 - Sliding glass door rollers
- 2 - Sliding glass door roller stops
- 1 - Sliding glass door floor guide
- 2 - 90 degree wall-to-upper track connectors
- 2 - 180 degree glass-to-sliding track connectors
- 1 - 914 mm half-round SDT980 threshold
- 1 - 2489 mm DK98L L-seal for wall

NOTE: Bottom fixed glass attachments, handles or knobs must be ordered separately.

FROM ONLY
£181.00*

CAT. NO.	DESCRIPTION	FINISH	1	6
HYDK60CH	Standard 180 degree kit 1524 mm	Bright Anodised / Chrome	£196.00	£181.00
HYDK60BN	Standard 180 degree kit 1524 mm	Brushed Nickel	£218.00	£205.00
HYDK84CH	Standard 180 degree kit 2134 mm	Bright Anodised / Chrome	£212.00	£197.00
HYDK84BN	Standard 180 degree kit 2134 mm	Brushed Nickel	£233.00	£219.00
HYDA9CH	90 degree wall-to-glass accessory kit	Bright Anodised / Chrome	£53.91	£50.79
HYDA9BN	90 degree wall-to-glass accessory kit	Brushed Nickel	£63.03	£59.40

*Minimum order: 1 each. Price based on an order quantity of 6 (HYDK60CH).

90 Degree** Wall-to-Glass Accessory Kit Includes:

- 1 - 90 degree glass-to-sliding track connector
- 1 - 90 degree wall-to-glass bracket

**90 degree units require that you order one 180 degree Standard Kit plus one 90 degree Accessory Kit



Maximum Capacities	8 mm to 10 mm	
	Weight	Door Width
HYDK60	40 kg	1520 mm
HYDK84	40 kg	2130 mm

NOTE: Do not exceed maximum door weight or width.



Image shown here:
HYDA9

CRL DELUXE SERENITY SERIES SLIDING SHOWER DOOR SYSTEM

- Unique 180° system with rollers above and below the header bar
- System features one sliding door and one fixed panel
- Fixed and sliding glass panels are reversible for installation (glass not included)
- Use of minimal hardware gives door an almost floating appearance
- Glass fabrication required
- Accessory kit available for 90° return panels (SER90MBL)
- For use with 8 to 10 mm monolithic toughened glass

Deluxe 180 Degree Kit Includes:

- 1 - 2 m length header support bar
- 4 - Rollers
- 1 - Stopper
- 2 - Track holder fittings for wall
- 2 - Track holder fittings for fixed panel
- 1 - Thru-glass pull
- 1 - Door guide
- 1 - 2.16 m length clear L-jamb

Maximum Capacities	8 mm to 10 mm	
	Weight	Door Width
	40 kg	762 mm

CAT. NO.	DESCRIPTION	FINISH	1	6
SER78BS	Deluxe 180 Degree Kit	Brushed Stainless	£243.00	£218.00
SER78PS	Deluxe 180 Degree Kit	Polished Stainless	£257.00	£238.00
SER78MBL	Deluxe 180 Degree Kit	Matte Black	£262.00	£242.00
SER90BS	90 Degree Accessory Kit	Brushed Stainless	£7.33	£6.77
SER90PS	90 Degree Accessory Kit	Polished Stainless	£7.97	£7.58
SER90MBL	90 Degree Accessory Kit	Matte Black	£9.79	£8.77
SERAHW2BS	Track Holder Fittings for Wall	Brushed Stainless	£21.06	£19.19
SERAHW2PS	Track Holder Fittings for Wall	Polished Stainless	£26.72	£22.39
SERAHW2MBL	Track Holder Fittings for Wall	Matte Black	£27.76	£24.79

*Minimum order: 1 each. Price based on an order quantity of 6 (SER78BS).



Image shown here:
SER90BS



SDH17UKA

SEE THE COMPLETE RANGE

To request your free copy, call free on
00 800 0421 6144 or VISIT crlaurence.co.uk

CRL TPC SURFACE PROTECTOR

- Transparent polymer coating
- Water, soil and stain repellent
- Protects glass and many other surfaces
- Clear coating guards against the adhesion and build-up of dirt, grime, mould, mildew, rust and mineral deposits
- Suitable for clear and sandblasted glass surfaces

WAS £8.40

NOW FROM ONLY

£7.68*
each



CAT. NO.	CONTENTS	1	12
TPC16	473 ml bottle	£8.33	£7.68
TPC5GL	18.9 Litre tub	£214.88	-

*Minimum order: 1 each. Price based on an order quantity of 12 (TPC16).

CRL SUPERIOR SQUEEGEE WITH CHROME CAP

- Wipes water spots from glass, tile and marble surfaces
- 254 mm blade in a 203 mm handle

WAS 14.62

NOW FROM ONLY

£7.99*
each



CAT. NO.	COLOUR	1	12
SQWC1	White	£9.13	£7.99
SQBC1	Black	£9.13	£7.99

*Minimum order: 1 each. Price based on an order quantity of 12 (SQWC1).

CRL CHROME DELUXE SHOWER SQUEEGEE

- Chrome handle with 254 mm wide grey blade
- Includes vacuum cup hook that requires no drilling

WAS £19.23

NOW FROM ONLY

£15.67*
each



CAT. NO.	DESCRIPTION	1
17600	Chrome Deluxe Shower Squeegee	£15.67

* Minimum order: 1 each. Price based on an order quantity of 1.

CRL EASI-CLEAN GLASS PROTECTOR FOR SANDBLASTED GLASS

- 3 year protection lifespan
- Ideal for sandblasted glass
- Nano-technology
- Long lasting - wide coverage

FROM ONLY

£39.73*
each

PROTECT SANDBLASTED SURFACES FROM GREASE

CAT. NO.	DESCRIPTION	VOLUME	1	6
ECSBP050	Easi-Clean Glass Protector	500 ml	£43.04	£39.73
ECSBP100	Easi-Clean Glass Protector	1 Litre	£92.55	£80.21

* Minimum order: 1 each. Price based on an order quantity of 6 (ECSBP050).



CRL PROTECT CLOTH

- To be used with ECSBP050 & ECSBP100

CAT. NO.	DESCRIPTION	1	10
ECSBPCLOTH	Green Protect Cloth	£1.52	£1.39

* Minimum order: 1 each. Price based on an order quantity of 10.

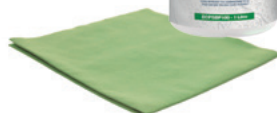

CRL PRE ASSEMBLED POST RAILING SYSTEM

Save time
& money

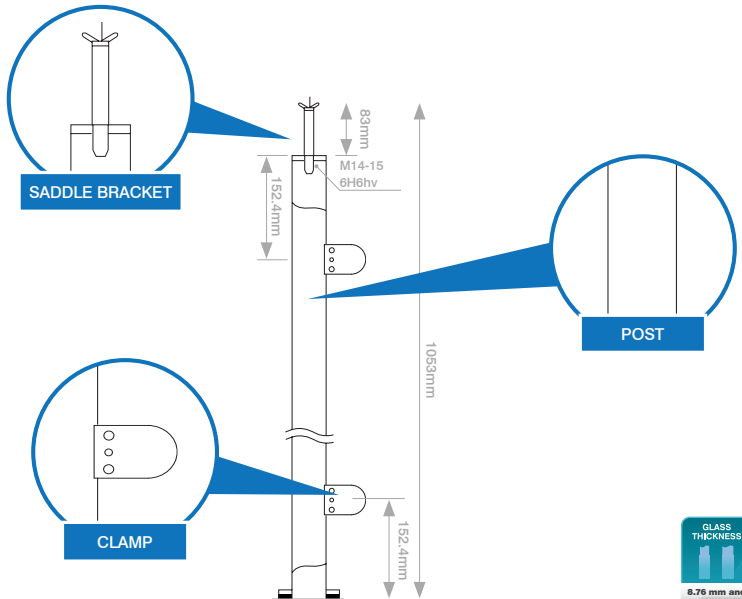

50.8MM POST KITS AND ACCESSORIES

- 50.8 mm post kits
- 316 grade stainless steel
- Sold as a complete post kit
- For 8.76 mm, 10 mm, 10.76 mm and 12 mm
- Available in brushed and polished stainless steel
- No clamps provided
- 2.5 mm material thickness

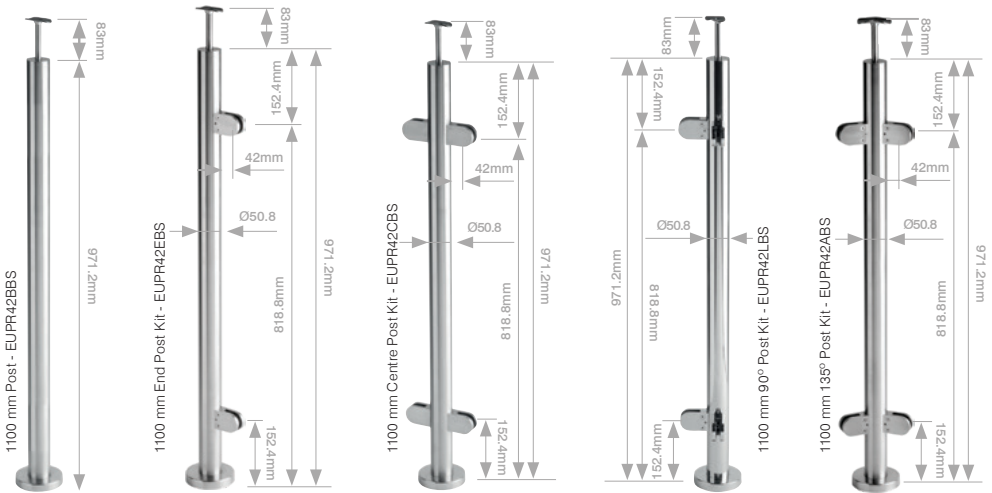
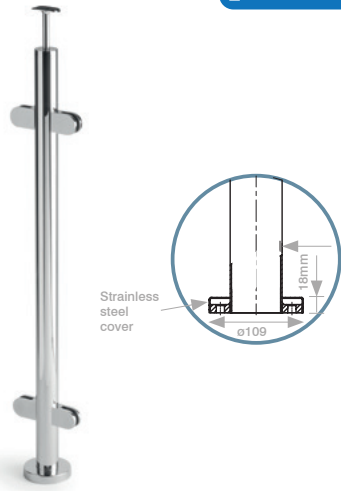

CAT. NO.	DESCRIPTION	FINISH	1	6
EUPR42BBS	1100 mm Post	Brushed Stainless Steel	£61.76	£59.70
EUPR42EBS	1100 mm End Post Kit	Brushed Stainless Steel	£82.35	£82.10
EUPR42EPS	1100 mm End Post Kit	Polished Stainless Steel	£85.48	£82.63
EUPR42CBS	1100 mm Centre Post Kit	Brushed Stainless Steel	£98.62	£95.22
EUPR42CPS	1100 mm Centre Post Kit	Polished Stainless Steel	£104.84	£99.12
EUPR42LBS	1100 mm 90° Post Kit	Brushed Stainless Steel	£100.11	£96.77
EUPR42LPS	1100 mm 90° Post Kit	Polished Stainless Steel	£104.82	£101.32
EUPR42ABS	1100 mm 135° Post Kit	Brushed Stainless Steel	£124.22	£120.08
EUPR42APS	1100 mm 135° Post Kit	Polished Stainless Steel	£128.78	£124.49

* Minimum order: 1 each. Price based on an order quantity of 6 (EUPR42BBS).

~~WAS £64.75~~

NOW FROM ONLY

£59.70*
each

3 M HAND RAIL TUBING

- For 50.8 mm post kits
- Sold per 3 metre length
- Used with European post kits
- Two architectural finishes
- 1.2 mm material thickness
- 316 grade stainless steel
- Available in brushed and polished stainless steel

~~WAS £48.98~~

NOW FROM ONLY

£45.98*
each

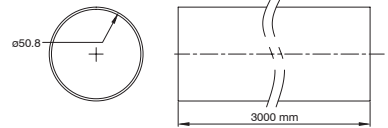

CAT. NO.	FINISH	1	6
EUHR20BS	Brushed Stainless Steel	£47.82	£45.98
EUHR20PS	Polished Stainless Steel	£51.91	£49.62

*Minimum order: 1 length. Price based on an order quantity of 6 (EUHR20BS).

INTERNAL CONNECTOR

- For 50.8 mm post kits
- Used with handrail tubing
- 316 grade stainless steel

~~WAS £8.04~~

NOW FROM ONLY

£7.52*
each

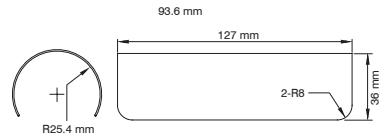

CAT. NO.	FINISH	1	6
EUHR20CSS	Brushed Stainless Steel	£7.78	£7.52

*Minimum order: 1 each. Price based on an order quantity of 6.

90° CORNER

- For 50.8 mm post kits
- Used with European post kits
- 316 grade stainless steel
- Sold individually

~~WAS £12.05~~

NOW FROM ONLY

£11.28*
each

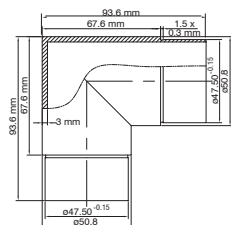

CAT. NO.	FINISH	1	6
EUHR20HBS	Brushed Stainless Steel	£11.67	£11.28
EUHR20HPS	Polished Stainless Steel	£12.72	£12.29

*Minimum order: 1 each. Price based on an order quantity of 6 (EUHR20HBS).

END CAP

- For 50.8 mm post kits
- Used with handrail tubing
- 316 grade stainless steel
- Sold individually

~~WAS £4.78~~

NOW FROM ONLY

£4.48*
each

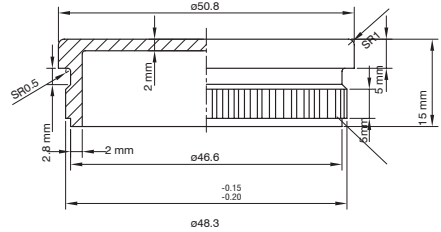

CAT. NO.	FINISH	1	6
EUHR20ECBS	Brushed Stainless Steel	£4.63	£4.48
EUHR20ECPS	Polished Stainless Steel	£5.08	£4.91

*Minimum order: 1 each. Price based on an order quantity of 6 (EUHR20ECBS).

SECURING END CAP

- For 50.8 mm post kits
- Used with handrail tubing
- 316 grade stainless steel
- Sold individually

~~WAS £5.61~~

NOW FROM ONLY

£5.49*
each

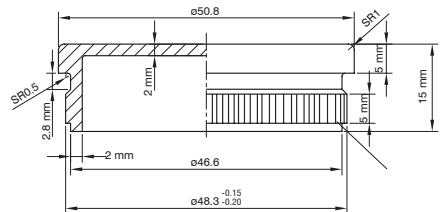

CAT. NO.	FINISH	1	6
EUHR20SECBS	Brushed Stainless Steel	£5.68	£5.49
EUHR20SECPS	Polished Stainless Steel	£6.54	£6.32

*Minimum order: 1 each. Price based on an order quantity of 6 (EUHR20SECBS).

CRL FULL FLANGE

- For 50.8 mm Tubing
- 316 grade stainless steel

~~WAS £10.74~~

NOW FROM ONLY

£10.05*
each

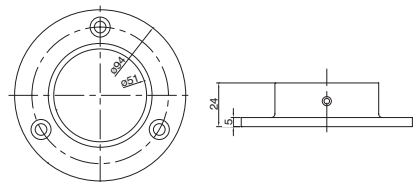

CAT. NO.	FINISH	1	10
EUHR20YBS	Brushed Stainless Steel	£10.40	£10.05
EUHR20YPS	Polished Stainless Steel	£10.81	£10.27

*Minimum order: 1 each. Price based on an order quantity of 6 (EUHR20YBS).



JULIETTE BALCONIES



CRL JULIETTE BALCONY CONNECTOR

- For use with the 48.3 mm EUGR20 Cap Rail
- 316 Grade Stainless Steel
- Tested to a width of 2400 mm certificate available
- Single pane of glass must be used for all widths of Juliette Balconies when using these products

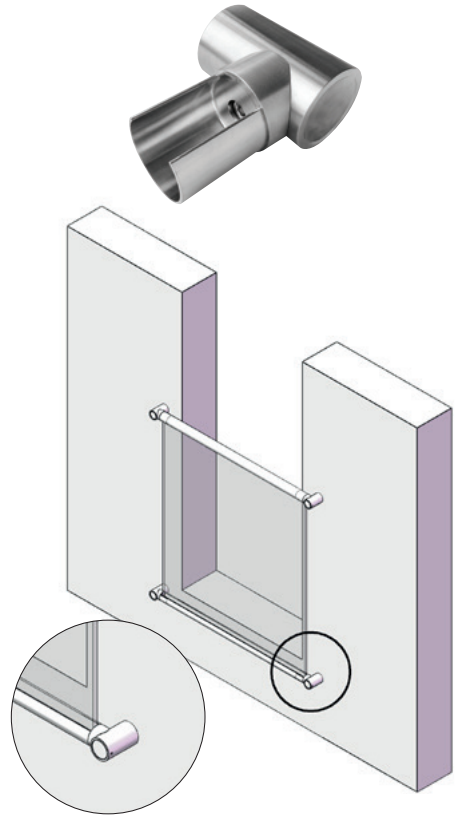
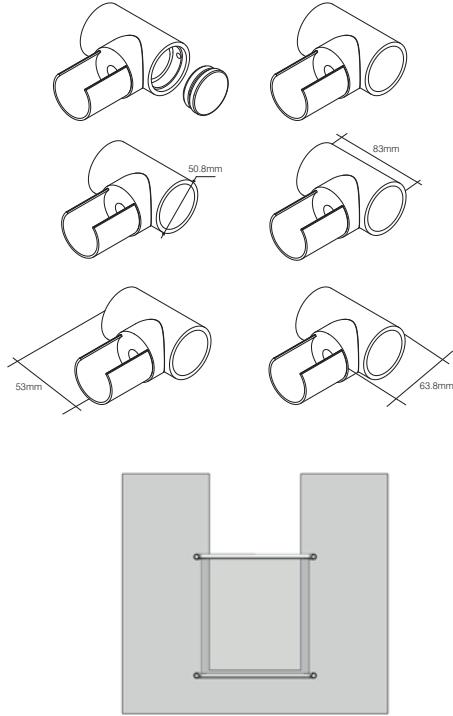

CAT. NO.	FINISH	1	10
EUGR20JBS	Brushed Stainless Steel	£57.20	£54.04
EUGR20JPS	Polished Stainless Steel	£58.22	£55.61

*Minimum order: 1 each. Price based on an order quantity of 10 (EUGR20JBS).

~~WAS £57.28~~

NOW FROM ONLY

£54.04*
each

48.3 MM DIAMETER CAP RAIL

- For 12 mm to 25.52 mm glass
- Connects to a variety of fabricated corners and end caps

CAT. NO.	FINISH	LENGTH	1	6
EUGR20BS	Brushed Stainless Steel	3 m	£44.77	£43.89
EUGR20BS14	Brushed Stainless Steel	4.2 m	£62.47	£58.57
EUGR20PS	Polished Stainless Steel	3 m	£81.43	£76.23
EUGR20PS14	Polished Stainless Steel	4.2 m	£113.77	£106.67

*Minimum order: 1 length. Price based on an order quantity of 6 (EUGR20BS).



~~WAS £46.26~~

NOW FROM ONLY

£43.89*
each

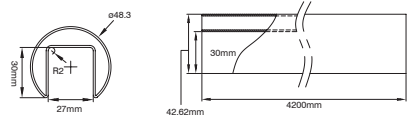

CRL LARGE D SHAPE FLAT BACK GLASS CLAMP

- For use on mezzanines, partitions, railings and windbreaks
- For 8 to 12.76 mm toughened or laminated glass
- Steel pin included for additional glass support
- Size 63 x 45 x 30 mm
- Sold individually
- Matching flat rubber gaskets available, sold as a pair

~~WAS £1.98~~

NOW FROM ONLY

£1.90*
each



Also available in radius back. Other gaskets available for other glass thicknesses

CAT. NO.	DESCRIPTION	FINISH	GLASS THICKNESS	FOR USE	1	50	100	500	1000
EUZFBBN	Large D Shape Flat Back Glass Clamp	Brushed Nickel	-	Internally	£3.14	£2.85	£2.61	£2.32	£2.10
EUZFBCH	Large D Shape Flat Back Glass Clamp	Chrome	-	Internally	£3.18	£2.89	£2.65	£2.34	£2.12
EUZFBZ	Large D Shape Flat Back Glass Clamp	Raw Zinc	-	Internally	£2.56	£2.30	£2.14	£1.94	-
EUZFBMBL	Large D Shape Flat Back Glass Clamp	Matt Black	-	Internally	£2.66	£2.42	£2.21	£2.04	£1.90
EUZFBBS	Large D Shape Flat Back Glass Clamp	Brushed Stainless	-	Externally	£5.41	£5.01	£4.66	£4.37	-
EUZFBPS	Large D Shape Flat Back Glass Clamp	Polished Stainless	-	Externally	£7.19	£6.65	£6.19	£5.79	-
EUZ8G	Rubber Gaskets	-	8 mm	-	£0.24	£0.23	£0.22	£0.20	£0.19
EUZ10G	Rubber Gaskets	-	10 mm	-	£0.24	£0.23	£0.22	£0.20	£0.19

* Minimum order: 1. Price based on an order quantity of 1000 (EUZFBMBL).

CRL SQUARE TYPE FLAT BACK GLASS CLAMPS

- For use on mezzanines, partitions, railings and windbreaks
- For 6 to 10.76 mm glass
- Safety pin not included
- Size 45 x 45 x 27 mm
- Sold individually
- Matching flat rubber gaskets available, sold as a pair

~~WAS £1.65~~

NOW FROM ONLY

£1.51*
each



Also available in radius back. Other gaskets available for other glass thicknesses

CAT. NO.	DESCRIPTION	FINISH	GLASS THICKNESS	FOR USE	1	50	100	500
EUZSFBBN	Square Type Flat Back Glass Clamp	Brushed Nickel	-	Internally	£2.79	£2.58	£2.41	£2.32
EUZSFZ	Square Type Flat Back Glass Clamp	Raw Zinc	-	Internally	£1.95	£1.79	£1.64	£1.51
EUZSFBBS	Square Type Flat Back Glass Clamp	Brushed Stainless	-	Internally	£5.29	£4.71	£4.23	£4.07
EUZSFBPS	Square Type Flat Back Glass Clamp	Polished Stainless	-	Internally	£6.45	£5.73	£5.15	£4.68
EUZS8G	Rubber Gaskets	-	8 mm	-	£0.26	£0.24	£0.22	£0.20
EUZS10G	Rubber Gaskets	-	10 mm	-	£0.26	£0.24	£0.22	£0.20

* Minimum order: 1. Price based on an order quantity of 500 (EUZSFZ).

CRL LARGE SQUARE TYPE FLAT BACK GLASS CLAMPS

- For use on mezzanines, partitions, railings and windbreaks
- For 6 to 12.76 mm toughened or laminated glass
- Safety pin included
- Side plates for use with laminated glass
- Size 55 x 55 x 35 mm
- Sold individually
- Matching flat rubber gaskets available, sold as a pair

~~WAS £2.74~~

NOW FROM ONLY

£2.43*
each



Also available in radius back. Other gaskets available for other glass thicknesses

CAT. NO.	DESCRIPTION	FINISH	GLASS THICKNESS	FOR USE	1	50	100	500
EUZLSFBBSL	Large Square Type Flat Back Glass Clamp	Brushed Stainless	-	Externally	£11.77	£11.18	£9.94	£8.95
EUZLSFBZL	Large Square Type Flat Back Glass Clamp	Raw Zinc	-	Externally	£3.22	£2.87	£2.57	£2.43
EUZLS8GL	Rubber Gaskets	-	8 mm	-	£0.39	£0.36	£0.33	£0.29
EUZLS10GL	Rubber Gaskets	-	10 mm	-	£0.39	£0.36	£0.33	£0.29

* Minimum order: 1. Price based on an order quantity of 500 (EUZLSFBZL).

CRL GLASS RAIL STANDOFF BASE AND CAP

- For use with 12 mm and 19 mm monolithic toughened glass or 13.5 mm and 21.5 mm laminated toughened glass using DuPont™ SentryGlas® Interlayers
- Designed for steel, wood and concrete substrates
- One 19 mm diameter hole per fitting
- 51 mm diameter caps
- 316 grade stainless finish



~~WAS £35.45~~

NOW FROM ONLY

£31.55*
each

CAT. NO.	FINISH	1	20
RSOB2134BS	Brushed Stainless	£36.02	£31.55
RSOB2134PS	Polished Stainless	£37.90	£33.10

*Minimum order: 1 each. Price based on an order quantity of 20 (RSOB2134BS).

CRL LANGLE FIX STANDOFFS

- AISI 304 grade stainless steel
- Salt Spray tested to 1000h NSS (DIN EN ISO 12944). Rating according to DINEN ISO 4628-2 and 4628-3
- Tested to DIN 18003-3
- Consisting of: 1 flat cap, 1 spacer, 2 EPDM, 1 EPDM



~~WAS £23.04~~

NOW FROM ONLY

£21.89*
each

CAT. NO.	DIAMETER	WALL-GLASS	STUD BOLT	GLASS THICKNESS	CUT OUT	1	20
RSOB45BS	Ø 45 mm	30 mm	M10x70	8 - 20 mm	Ø 22 mm	£23.88	£21.89
RSOB60BS	Ø 60 mm	30 mm	M10x70	10 - 24 mm	Ø 26 mm	£31.10	£28.50

*Minimum order: 1 each. Price based on an order quantity of 20 (RSOB45BS).

CRL LANGLE ADJUSTABLE STANDOFFS

- AISI 304 grade stainless steel
- Salt Spray tested to DIN EN ISO 4628-2 and 4628-3
- Tested to DIN EN ISO 18003-3
- Consisting of: 1 flat cap, 1 spacer, 1 fixing disc, 2 EPDM washers, 2 EPDM sleeve, 2 stud bolts M10 (application depending on glass thickness)

~~WAS £32.29~~

NOW FROM ONLY

£29.25*
each



CAT. NO.	DIAMETER	WALL-GLASS	STUD BOLT	GLASS THICKNESS	CUT OUT	1	20
RS0BA45BS	Ø 45 mm	25 - 35 mm	M10x30 M10x35	16 - 20 mm 24 mm	Ø 22 mm Ø 22 mm	£33.50	£29.25
RS0BA60BS	Ø 60 mm	25 - 35 mm	M10x30 M10x35	16 - 20 mm 24 mm	Ø 26 mm	£38.66	£35.44

*Minimum order: 1 each. Price based on an order quantity of 20 (RS0BA45BS).



CRL POSIGLAZE SURFACE MOUNT BASE SHOE



**For a standard 3 m surface mount installation,
the following components will be required:**

- 1 x 3 m Surface Mount Base Shoe
- 2 x 3 m Top Clip
- 1 x Clamp kit to suit specified glass thickness
- 1 x Spanner

CRL POSIGLAZE SURFACE MOUNT BASE SHOE

- For use with 12 to 21.52 mm glass
- Pre-drilled first hole from edge of base shoe: 100 mm
- Pre-drilled centre-to-centre hole distance: 200 mm
- Hole suited to 12 mm fixing bolt and counter bored to sink the bolt head
- 3 m length

~~WAS £175.00~~

NOW FROM ONLY

£166.00*
each

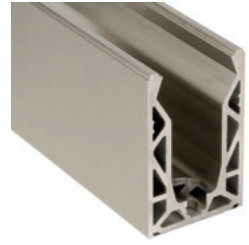

CAT. NO.	DESCRIPTION	FINISH	1	6
EPGDSSA	Surface Mount Base Shoe	Steel Anodised	£177.00	£166.00

*Minimum order: 1 each. Price based on an order quantity of 6.

CRL POSIGLAZE TOP CLIP

- Holds the gasket
- Presses onto the channel at the end of the installation
- Covers the clamps from and prevents debris from entering the channel
- 3 m length

~~WAS £12.25~~

NOW FROM ONLY

£11.41*
each

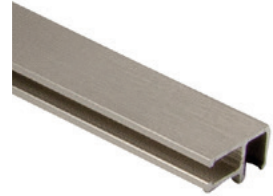

CAT. NO.	DESCRIPTION	1	6
EPGTSSA	Top Clip	£11.93	£11.41

*Minimum order: 1 each. Price based on an order quantity of 6.

CRL POSIGLAZE CLAMP KITS (INC. CLAMPS, GASKET, BARS, BOLTS)

- Includes enough components to suit a 3 m length of base shoe
- Glass clamps have a ± 1 mm tolerance to accommodate varying interlayer thicknesses in the glass
- Includes the clamp bars which sit into the top mould of the clamps and the clamp bolts which screw into the bars and are then undone to hold the glass in place. These are undone and tightened each side allowing the glass alignment
- Includes 6 m gasket to suit glass thickness

~~WAS £48.99~~

NOW FROM ONLY

£45.64*
each



CAT. NO.	DESCRIPTION	1	6
EPG12SET	Clamp Kits for 12 mm glass	£48.96	£45.64

*Minimum order: 1 each. Price based on an order quantity of 6.

CRL POSIGLAZE SPANNER

- With angle to reach the clamp to tighten/loosen the glass
- Material: Steel

~~WAS £5.66~~

NOW FROM ONLY

£5.38*
each



CAT. NO.	DESCRIPTION	1	6
EPGSPAN	Spanner	£5.78	£5.38

*Minimum order: 1 each. Price based on an order quantity of 6.



CRL SPIG-LITE PRO



For a standard 1 m glass balustrade, the following components will be required:

- 2 x Spigots
- 2 x Clamps
- 4 x Top Clips
- 1 x 1 m length Gasket
- 1 x Spanner

CRL SPIG-LITE SPIGOT

- For use with 12 to 21.52 mm glass
- Pre-drilled in the centre
- Pre-finished Graphite Grey

CAT. NO.	DESCRIPTION	1	6
ESP1G	Spigot	£39.00	£37.00

*Minimum order: 1 each. Price based on an order quantity of 6.

WAS ~~£39.33~~

NOW FROM ONLY

£37.00*
each



CRL SPIG-LITE CLAMP KITS

- Glass clamps have a ± 1 mm tolerance to accommodate varying interlayer thicknesses in the glass
- Includes the clamp bars which sit into the top mould of the clamps and the clamp bolts which screw into the bars and are then undone to hold the glass in place. These are undone and tightened each side allowing the glass alignment.

CAT. NO.	DESCRIPTION	1	6
ESP1G12C	Clamp Kits	£8.22	£7.52

*Minimum order: 1 each. Price based on an order quantity of 6.

WAS ~~£8.32~~

NOW FROM ONLY

£7.52*
each



CRL SPIG-LITE TOP CLIP

- Holds the gasket
- Pressed onto the channel at the end of the installation
- Pre-finished Graphite Grey

CAT. NO.	DESCRIPTION	1	6
ESP1GTCL	Top Clip	£2.31	£2.16

*Minimum order: 1 each. Price based on an order quantity of 6.

WAS ~~£2.28~~

NOW FROM ONLY

£2.16*
each



CRL SPIG-LITE GASKET

- 1 m length

CAT. NO.	DESCRIPTION	1	6
ESP1GGL	Gasket	£1.95	£1.92

*Minimum order: 1 each. Price based on an order quantity of 6.

FROM ONLY

£1.92*
each



CRL SPIG-LITE SPANNER

- With angle to reach the clamp to tighten/loosen the glass
- Material: Steel

CAT. NO.	DESCRIPTION	1	6
EPGSPAN	Spanner	£5.78	£5.38

*Minimum order: 1 each. Price based on an order quantity of 6.

WAS ~~£5.66~~

NOW FROM ONLY

£5.38*
each



CRL DOOR CONTROLS

CRL FLOOR SPRING AND PATCH FITTING SET

- Floor Spring and Patch Fitting Set includes:
 - 1 x Bottom Door Patch Insert (1NT301)
 - 1 x Top Door Patch Insert (1NT303)
 - 1 x Top Free Swinging Pivot (1NT401)
 - 1 x 180D Adjustable Closer/90D HO Floor Mount (EUCRL8460V)
 - 1 x PS Ladder Pull 600 mm L 32 mm D (EULP60032BS)
 - 1 x Brushed Stainless Steel Euro Top/bottom Door Patch (EUR201BS)
- For use with 10 to 12 mm monolithic toughened glass
- Max door weight: 100 kg
- Max door width: 1100 mm
- Quick installation - no hole required in the floor
- Glass fabrication required



1NT301



1NT303



1NT401



EUCRL8460V



EULP60032

EUR201

FROM ONLY

£148.69*
each

CAT. NO.	DESCRIPTION	FINISH	1
CRL8460BSSET	Floor Spring and Patch Fitting Set	Brushed Stainless	£148.69
CRL8460PSSET	Floor Spring and Patch Fitting Set	Polished Stainless	£152.91

*Minimum order: 1 each. Price based on an order quantity of 1 (CRL8460BSSET).

CRL HYDRAULIC PATCH FITTINGS WITH BACKCHECK

- Kit includes 1 x hydraulic patch fitting with back check (CRL380), 1 x top door patch fitting (PH21ABS) and 1 x centre-hung free swinging top pivot (1NT401)
- For use with 10 to 12 mm monolithic toughened glass
- Max door weight: 100 kg
- Max door width: 1100 mm
- Adjustable closing speed from 110° to 20° and from 20° to 0°
- Quick installation - no hole required in the floor
- Glass fabrication required



CRL380

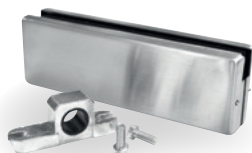

PH21ABS



1NT401

CAT. NO.	DESCRIPTION	FINISH	1	6
CRL380BSSET	Kit with no hold open	Brushed Stainless	£114.00	£109.00
CRL380PSSET	Kit with no hold open	Polished Stainless	£114.00	£109.00
CRL380HBSSET	Kit with hold open	Brushed Stainless	£120.00	£114.00
CRL380HPSSET	Kit with hold open	Polished Stainless	£120.00	£114.00

*Minimum order: 1 each. Price based on an order quantity of 1 (CRL380BSSET).

~~WAS £119.00~~

NOW FROM ONLY

£109.00*
each



CRL OIL DYNAMIC WALL-TO-GLASS HINGE

- Adjustable closing speed
- Swings in and out a full 90 degrees, with stops at 0°, +90°, and -90°
- Also available in no-hold open option
- For use with 8 to 13.52 mm toughened glass
- 100 kg max door weight
- 1000 mm max door width
- No hold open option also available on all models



CAT. NO.	DESCRIPTION	FINISH	1	6
H8010CH	Wall-to-Glass Hinge	Chrome	£111.00	£106.00
H8010SN	Wall-to-Glass Hinge	Satin Nickel	£118.00	£114.00
H8015CH	Glass-to-Glass Hinge	Chrome	£147.00	£142.00
H8015SN	Glass-to-Glass Hinge	Satin Nickel	£162.00	£155.00

*Minimum order: 1 each. Price based on an order quantity of 6 (H8010CH).

WAS £110.39

NOW FROM ONLY

£106.00*
each

CRL LADDER PULL HANDLE

- Sold as a pair
- Ladder style pull handles for back-to-back mounting
- Through-bolts supplied
- For use with 8 to 19 mm glass
- 12 mm diameter holes required

WAS £27.90

NOW FROM ONLY

£20.94*
each

CAT. NO.	LENGTH	CENTRE-TO-CENTRE	FINISH	1	5
EULP30019BS	300 mm	200 mm	Brushed Stainless	£26.18	£20.94
EULP30019PS	300 mm	200 mm	Polished Stainless	£29.22	£25.04
EULP60032BS	600 mm	450 mm	Brushed Stainless	£34.98	£28.86
EULP60032PS	600 mm	450 mm	Polished Stainless	£35.48	£30.16
EULP100032BS	1,000 mm	800 mm	Brushed Stainless	£57.61	£47.53
EULP100032PS	1,000 mm	800 mm	Polished Stainless	£60.50	£49.91

*Minimum order: 1 pair. Price based on an order quantity of 5 pairs (EULP30019BS).



CRL ALUMINIUM GLAZING PROFILES

END CAPS
AVAILABLE

CRL WET/DRY GLAZE U-CHANNEL

- Typically used at the bottom of glass panels
- Use with silicone (wet) or glazing gasket (dry) for 10 and 12 mm toughened glass
- 3 m stock lengths
- Also available in 6 m stock lengths

CAT. NO.	DEPTH	FINISH	1	10
WU3SASL	25.4 mm	Satin Anodised	£24.14	£22.23
WU3BSASL	25.4 mm	Brushed Stainless Anodised	£33.41	£32.30
WU3BASL	25.4 mm	Bright Anodised	£37.53	£36.08
WU1SASL	38 mm	Satin Anodised	£31.02	£27.66
WU1BSASL	38 mm	Brushed Stainless Anodised	£48.81	£45.19
WU1BASL	38 mm	Bright Anodised	£46.17	£44.39
WU2SASL	51 mm	Satin Anodised	£43.91	£37.98
WU2BSASL	51 mm	Brushed Stainless Anodised	£56.83	£53.16
WU2BASL	51 mm	Bright Anodised	£61.28	£60.09

*Minimum order: 1 stock length. Price based on an order quantity of 10 stock lengths (WU3SASL). Packing charge added to orders of fewer than 5 assorted lengths of any U-channels.

CAT. NO.	DESCRIPTION	1	6
RG38100	Gasket - Used with 10 mm glass	£23.82	£22.28
RG12100	Gasket - Used with 12 mm glass	£17.97	£16.85

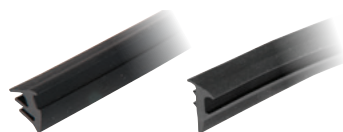
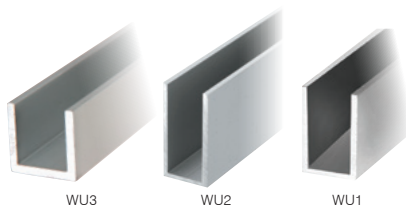

To secure 10 mm glass,
order gasket RG38100

To secure 12 mm glass,
order gasket RG12100

~~WAS £27.32~~

NOW FROM ONLY

£22.23*
each



CRL CLEAR GLASS JOINT SYSTEM 180° PARTITION STRIP

- Provides a clear slimline finish between two glass panels
- Excellent adhesion from pre-applied high bond tape
- 3 m lengths

~~WAS £6.75~~

NOW FROM ONLY

£5.38*
each

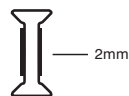
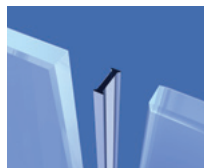

CAT. NO.	GLASS THICKNESS	GLASS TYPE	1	25	50
EZCC10	10 mm	Toughened	£6.57	£5.92	£5.38
EZCC108	10.8 mm	Laminated	£6.84	£6.16	£5.60
EZCC12	12 mm	Toughened	£6.69	£6.02	£5.47
EZCC128	12.8 mm	Laminated	£7.07	£6.36	£5.78

*Minimum order: 1 each. Price based on an order quantity of 50 (EZCC10).

CRL CLEAR GLASS JOINT SYSTEM 90° CORNER PROTECTION STRIP

- Provides a clear slimline finish between two glass panels
- Excellent adhesion from pre-applied high bond tape
- 3 m lengths

~~WAS £7.34~~

NOW FROM ONLY

£5.92*
each

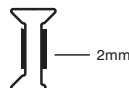

CAT. NO.	GLASS THICKNESS	GLASS TYPE	1	25	50
EZCL10	10 mm	Toughened	£7.40	£6.58	£5.92
EZCL108	10.8 mm	Laminated	£7.70	£6.84	£6.16
EZCL12	12 mm	Toughened	£7.55	£6.71	£6.04
EZCL128	12.8 mm	Laminated	£7.95	£7.07	£6.36

*Minimum order: 1 each. Price based on an order quantity of 50 (EZCL10).

CRL CLEAR GLASS JOINT SYSTEM 3-WAY PARTITION STRIP

- Provides a clear slimline finish between two glass panels
- Excellent adhesion from pre-applied high bond tape
- 3 m lengths

~~WAS £10.93~~

NOW FROM ONLY

£9.42*
each

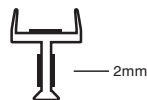

CAT. NO.	GLASS THICKNESS	GLASS TYPE	1	25	50
EZCT10	10 mm	Toughened	£11.77	£10.56	£9.42
EZCT108	10.8 mm	Laminated	£12.01	£10.67	£9.61
EZCT12	12 mm	Toughened	£12.15	£10.81	£9.72
EZCT128	12.8 mm	Laminated	£12.42	£11.04	£9.94

*Minimum order: 1 each. Price based on an order quantity of 50 (EZCT10).

CRL CLEAR GLASS JOINT SYSTEM ABUTMENT STRIP

- Provides a clear slimline finish between two glass panels
- Excellent adhesion from pre-applied high bond tape
- 3 m lengths

~~WAS £7.65~~

NOW FROM ONLY

£6.36*
each

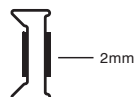

CAT. NO.	GLASS THICKNESS	GLASS TYPE	1	25	50
EZCE10	10 mm	Toughened	£7.95	£7.07	£6.36
EZCE108	10.8 mm	Laminated	£8.49	£7.55	£6.79
EZCE12	12 mm	Toughened	£8.11	£7.21	£6.48
EZCE128	12.8 mm	Laminated	£8.45	£7.51	£6.76

*Minimum order: 1 each. Price based on an order quantity of 50 (EZCE10).

CRL CLEAR GLASS JOINT SYSTEM 180° IN-LINE 2-WAY PARTITION STRIP

- Clips over the glass joint
- Does not feature clear high bond tape
- 3 m lengths

~~WAS £5.57~~

NOW FROM ONLY

£5.06*
each



CAT. NO.	GLASS THICKNESS	GLASS TYPE	1	25	50
CLON10	10 mm	Toughened	£6.07	£5.52	£5.06
CLON108	10.8 mm	Laminated	£6.07	£5.53	£5.06
CLON12	12 mm	Toughened	£6.85	£6.68	£6.37
CLON128	12.8 mm	Laminated	£6.76	£6.16	£5.54

*Minimum order: 1 each. Price based on an order quantity of 50 (CLON10).

CRL CLEAR GLASS JOINT SYSTEM 90° 2-WAY PARTITION STRIP

- Clips over the glass joint
- Excellent adhesion from pre-applied clear high bond tape
- 3 m lengths

~~WAS £8.04~~

NOW FROM ONLY

£7.12*
each

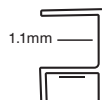

CAT. NO.	GLASS THICKNESS	GLASS TYPE	1	25	50
CLON210	10 mm	Toughened	£8.68	£7.91	£7.12
CLON2108	10.8 mm	Laminated	£8.83	£8.04	£7.24
CLON212	12 mm	Toughened	£9.38	£8.56	£7.71
CLON2128	12.8 mm	Laminated	£9.54	£8.69	£7.82

*Minimum order: 1 each. Price based on an order quantity of 50 (CLON210).

CRL CLEAR GLASS JOINT SYSTEM 90° 3-WAY PARTITION STRIP

- Clips over the glass joint
- Excellent adhesion from pre-applied clear high bond tape
- 3 m lengths

~~WAS £7.92~~

NOW FROM ONLY

£6.96*
each

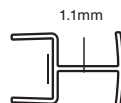

CAT. NO.	GLASS THICKNESS	GLASS TYPE	1	25	50
CLON310	10 mm	Toughened	£8.49	£7.73	£6.96
CLON3108	10.8 mm	Laminated	£8.63	£7.87	£7.08
CLON312	12 mm	Toughened	£9.19	£8.38	£7.54
CLON3128	12.8 mm	Laminated	£9.34	£8.51	£7.66

*Minimum order: 1 each. Price based on an order quantity of 50 (CLON310).

CRL CLEAR GLASS JOINT SYSTEM 135° 2-WAY PARTITION STRIP

- Clips over the glass joint
- Excellent adhesion from pre-applied clear high bond tape
- 3 m lengths

~~WAS £11.03~~

NOW FROM ONLY

£9.74*
each

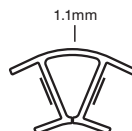

CAT. NO.	GLASS THICKNESS	GLASS TYPE	1	25	50
CLON410	10 mm	Toughened	£11.88	£10.82	£9.74
CLON4108	10.8 mm	Laminated	£12.02	£10.96	£9.86
CLON412	12 mm	Toughened	£12.83	£11.69	£10.52
CLON4128	12.8 mm	Laminated	£12.97	£11.82	£10.64

*Minimum order: 1 each. Price based on an order quantity of 50 (CLON410).



CRL COMPACT-X

Sliding Door System

CRL COMPACT-X is a compact sliding solution for frameless glass panels, combining the latest technology with an attractive minimalist design. The system is quick and easy to install with double soft close.

Features

- Quick and easy to install
- Suitable for ceiling, glass and wall mounted applications
- Vertical adjustment
- For use with 8 mm, 8.76 mm, 10 mm and 10.76 mm glass
- Available in Brushed Nickel and Satin Anodised finishes
- Available in a 3 metre kit as well as 3 and 5 metre kits with fixed panel
- Option to install Bi-parting doors by purchasing extra set of clamps
- Can be used for both commercial and shower applications

ENHANCED DOUBLE SOFT CLOSE SYSTEM

DOOR SYSTEM LIMITATIONS

Maximum Door Weight	70 kg
Minimum Panel Width	635 mm
Maximum Track Length	5000 mm



CRL Brooklyn

A matte black frame system for sliding doors

New for 2020, CRL Brooklyn is an innovative, style-led sliding door frame system designed for both residential and commercial use.

Allowing practical room partitioning, while still retaining a sense of space, Brooklyn is set to be one of the most popular systems available.

Elegance in the home

Create the ideal interior door system, combining the minimalistic style of a matte black frame with a door design that makes the very best use of natural light within a home.

Commercial style

Perfect for use in restaurants and office environments, the Brooklyn system is an ideal partitioning solution in locations where an inviting sense of light is key.

Developed with classic lines, the system complements a wide range of interior styles.

80% ALCOHOL SURFACE SANITISER SPRAY

- 400 ml
- Fast application
- Covers large areas quickly and easily

CAT. NO.	DESCRIPTION	1	12	24
OB1SS	400 ml Sanitiser Spray	£9.73	£7.78	£7.07

*Minimum order: 1 each. Price based on an order quantity of 24.

FROM ONLY

£7.07*
each



70% ALCOHOL HAND SANITISER GEL

- 500 ml
- Protective against harmful virus and bacteria
- Fast drying
- Provides prolonged protection to hands and skin
- Proven hand hygiene aid for instant protection and safety
- Contains an emollient to protect skin

CAT. NO.	DESCRIPTION	1	12	24
OB1HS	500 ml Sanitiser Bottle	£9.95	£7.96	£7.24

*Minimum order: 1 each. Price based on an order quantity of 24.

FROM ONLY

£7.24*
each



DISPOSABLE FACE MASK

- Pack of 50

CAT. NO.	DESCRIPTION	50
CRLMASK	50 Face Masks	£43.18

FROM ONLY

£43.18
each



The Complete Collection

- SDH17UKA Shower Door Hardware
- EUAGF17 Architectural Glass Fixings
- GG2014A Glass and Glazing Accessories
- TL19UK TAPER-LOC® Frameless Glass Balustrade System
- DH19UK Door Hardware
- S018DEUKFR Standoff Systems
- MBL18UK Matte Black Shower Range



For your copy call: **00 800 0421 6144** or email: crl@crlaurence.co.uk

For more information Freephone 00 800 0421 6144 (UK & Europe) | Freefax 00 800 0262 3299



All prices are in pounds sterling - prices do not include VAT. All products F.O.B. CRL Services Centre. Prices valid until 31st December 2020.